

# Accessories and Suspension

**PRODUCT CATALOGUE AND PRICE LIST**

Effective 1 November 2021



**RETAIL**



**VOLUME 21**

# Warranty

Ironman 4x4 warrants the original buyer, only when purchased new via authorised Ironman 4x4 resellers and distributors, from date of retail sale and cannot be transferred. Product is warranted against defects in material or workmanship that cause the product to perform below the specified limits set by Ironman 4x4, to the extent that Ironman 4x4 will repair or replace any parts which are found to be defective.

It is at the discretion of Ironman 4x4 if a repair will be made or a replacement issued once the product has been inspected by an Ironman 4x4 representative and deemed to be a genuine warrantable claim. All warranty claims must be submitted via original purchasing store or chain, unless otherwise arranged. Proof of original purchase must be presented upon request.

**PLEASE NOTE:**

**No Warranty Claims or Goods Returned will be accepted unless accompanied by a completed WARRANTY CLAIM / GOODS RETURN FORM.**

Products may be required to be returned to Ironman 4x4 for assessment or repair. Ironman 4x4 is not responsible for postage or removal costs involved, but assistance may be considered at the discretion of Ironman 4x4 in the event of such a claim being verified.

The warranty does NOT apply where, 1) acts of neglect or misuse are evident, 2) product has been modified, 3) vehicles which are modified or not the recommended vehicle of use, 4) used in racing or competition conditions without the prior consent of Ironman 4x4, 5) used beyond the expectations of the original vehicle manufacturer.

Before installation of any product, please ensure you have received the correct parts for your application. Ordering of the correct parts is the responsibility of the buyer. Return of a product in an unused condition will attract a 15% restock fee, where Ironman 4x4 is not at fault.

Return of used or soiled product, 1) outside warranty period, 2) without fault, will result in refusal of your claim and be returned at buyer's expense. Damage to products through fitment error is not covered under warranty.

Our goods come with statutory guarantees that cannot be excluded under Australian Consumer Law. You are entitled to a replacement or refund for a major failure and for compensation for any other reasonably foreseeable loss or damage contingent on that failure. You are also entitled to have the goods repaired or replaced if they fail to be of acceptable quality even if the failure does not amount to a major failure.

**FREIGHT CONDITIONS:**

Freight of all products is the buyer's responsibility. Where Ironman 4x4 have arranged freight, costs involved will be invoiced to the buyer. Ironman 4x4 is not responsible for damage or loss during freight.

**FITTING:**

All prices listed may be subject to fitting costs. The price of fitting is determined by the individual fitting agent.

**Pricing subject to change without notice.**

For further information please contact us on 1300 731 137 or email [info@ironman4x4.com](mailto:info@ironman4x4.com).

**ACCESSORIES WARRANTY:**

Fitment should be performed by an authorised or licensed mechanic, competent with 4x4 accessory installations. Special tools may be required when fitting some parts. Damage to products through fitment error is not covered under warranty. Warranty may become void when product is installed in conjunction with anything other than genuine manufacturer or Ironman 4x4 components.

1 YEAR	2 YEAR	5 YEAR	LIMITED LIFETIME	3 YEAR COMPONENTS, 5 YEAR COMPRESSOR
Accessories / Canopies / Mining Accessories Underbody Protection	Premium Underbody Protection	Monster Winch  Snorkel	TREDS	IceCube Fridge / Freezer

**SUSPENSION WARRANTY:**

All suspension products must undergo a safety check at 500km after fitment. Fitment should be performed by an authorised or licensed mechanic, competent with suspension installations. Special tools may be required when fitting some parts including struts. Damage to products through fitment error is not covered under warranty. Warranty may become void when product is installed in conjunction with anything other than genuine manufacturer or Ironman 4x4 components.

Where required, Ironman 4x4 recommend wheel alignment after fitment of any new suspension component. Obtaining wheel alignments is the responsibility of the buyer.

2 YEAR	3 YEAR / 60,000 KM
Load Plus Helper Springs GVM Upgrades	Suspension

The names and reference numbers of manufacturers and suppliers other than Ironman 4x4 Pty Ltd used in this product catalogue are shown only to assist our customers in identifying replacement parts. Under no circumstances does Ironman 4x4 Pty Ltd imply that the parts sold by Ironman 4x4 are those of the OE manufacturers. Although care has been taken to ensure accuracy of data contained in this publication, Ironman 4x4 Pty Ltd does not assume any liability for errors or omissions.

©Copyright 2021 Ironman 4x4 Pty Ltd. No part of this publication may be reproduced or replicated without the prior written consent of Ironman 4x4 Pty Ltd.





<b>4WD AND TOURING GEAR PRODUCT</b>	
<b>ACCESSORIES AND SUSPENSION PRODUCT BY VEHICLE</b>	
<b>ACCESSORY AND SUSPENSION SPARE PARTS</b>	
<b>PRODUCT INSTALL TIMES GUIDE</b>	
<b>GVM UPGRADES</b>	
<b>SUSPENSION SELECTION INFORMATION</b>	
<b>SUSPENSION TECHNICAL SPECIFICATIONS</b>	
<b>ACCESSORY SELECTION INFORMATION</b>	
<b>ACCESSORY TECHNICAL SPECIFICATIONS</b>	
<b>PRODUCT CODE QUICK REFERENCE</b>	

# Contents - Accessories to Suit

## 4WD AND TOURING GEAR

### RECOVERY EQUIPMENT

Electric Winches and Accessories .....	10
Recovery Kits, Straps and Accessories .....	10-11
Compressors .....	12
Tyre Accessories and Lifting Jacks .....	12
Recovery Boards .....	13
Multi-Purpose Rear Wheel Bag .....	13
Seat Covers .....	13
Anchor Track .....	13

### CAMPING ACCESSORIES

Camp Chairs .....	14
Camp Tables .....	14
Swags and Stretchers .....	15
Sleeping Bags .....	15
Toilets .....	16
Showers .....	16
Camp Steps .....	16
Camp Kitchen .....	17
Camp Tools .....	17
Cleaning .....	17
Torches .....	18
Fans .....	18
Camp Lighting .....	18
Camp Power .....	19
Solar .....	19

### FRIDGE / FREEZERS

Fridge / Freezers .....	20
Fridge Slides .....	21
Fridge Accessories .....	21

### CAMPING

Rooftop Tents .....	22-23
Rooftop Tent Accessories .....	22-23
DeltaWing 270° Awnings .....	24-25
DeltaWing 270° Awning Accessories .....	25
Instant Awnings .....	26
Awning Xtra Weathershield .....	26
Awning Quick Release .....	26
Room Enclosures .....	26
Instant Ensuite .....	26

### DRIVING LIGHTS

LED Driving Lights .....	27
LED Light Bars .....	28-29
Driving Light Accessories .....	29
Universal LED Work Lights .....	30
Bull Bar Cube Lights .....	30
Light Wiring Looms .....	31

### AUTO ELECTRICAL

Auto Electrical .....	31
Dual Battery Systems .....	31

### STORAGE

Single Drawer Systems .....	32
Twin Drawer Systems .....	32
Wing Kits .....	32
Fridge Slides .....	21
Water Tanks .....	33
Maxi Cases .....	34
Ute Boxes .....	34
Aluminium Tool Boxes .....	35
Steel Truck Boxes .....	35

Rooftop Bags .....	36
Rooftop Tent Hanging Bags / General Camping Bags .....	36

### ROOF RACKS

Alloy Roof Racks .....	37
Steel Roof Racks .....	38
Universal Roof Rail Extrusions .....	37
Mounting Kits .....	38

### FLEET AND MINING

Fleet and Mining Accessories .....	39
------------------------------------	----

### APPAREL

T-Shirts .....	40
Baseball Caps .....	40
Oilskin Jackets .....	40
Oilskin Vests .....	40

### MERCHANDISE

Ironman 4x4 Merchandise .....	41
-------------------------------	----

## ACCESSORIES TO SUIT (BY VEHICLE)

### FIAT

Fullback .....	45
----------------	----

### FORD

Everest	UAII 7/2018+ .....	67
	9/2015 to 6/2018 .....	69
F150	2015 to 2020 .....	45
Maverick	1988 to 1994 (See Nissan Patrol Page 228) .....	228
Ranger	Raptor 9/2018+ .....	50
	PX Mk III 8/2018+ .....	52
	PX Mk II 2015 to 7/2018 .....	56
	PX 7/2011 to 2015 .....	60
	PJ / PK 2006 to 2011 .....	64

### GM / CHEVROLET / HOLDEN

Colorado	RG 11/2016 to 2020 .....	80
	RG 2012 to 10/2016 .....	85
	RC 7/2008 to 12/2012 .....	87
Colorado 7	RG 2012+ .....	78
Rodeo	RA7 2007 to 7/2008 .....	89
	RA 2002 to 2006 .....	91
Silverado	1500 2019+ .....	71
Trailblazer	LT / LTZ 2017+ .....	76

### HYUNDAI

iLoad .....	96
-------------	----

### ISUZU

D-Max	8/2019+ .....	98
	2/2017 to 7/2019 .....	101
	6/2012 to 1/2017 .....	104
	2007 to 6/2012 .....	108
MU-X	2014+ .....	110

### JEEP

Gladiator	JT 4/2019+ .....	118
Grand Cherokee	WK2 8/2013+ .....	120
Wrangler	JL 2018+ .....	124
	JK 2007+ .....	126

### LAND ROVER

Defender	2007-2016 .....	133
Discovery	Series 2, 3 and 4 .....	138

### LDV

T60	2.8L Turbo Diesel 2017+ .....	142
-----	-------------------------------	-----

### MAZDA

BT-50	6/2020+ .....	147
	2012 to 5/2020 .....	150
	J97M 2006 to 2012 .....	154





# Contents - Accessories to Suit

## MITSUBISHI

Pajero	NW-NX 2011 .....	166
	NM, NP, NS, NT 5/2000 to 2011 .....	167
Pajero Sport	7/2019+ .....	162
	11/2016 to 6/2019 .....	164
Triton	MR 11/2018+ .....	178
	MQ 2015 to 10/2018 .....	182
	MN 2009 to 2015 .....	187
	ML 2006 to 2009 .....	190

## NISSAN

Navara	NP300 Series 5 2021+ .....	197
	NP300 2015 to 2020 .....	200
	D40 2005+ .....	203
	D22 2002+ .....	206
Pathfinder	R51 2005 to 2013 .....	210
Patrol	Y62 2010 to 2019 .....	216
	Y61 GU Series 4 2005+ .....	218
	Y61 GU Series 1-3 1998 to 2004 .....	219
	Y60 GQ Station Wagon 1987 to 1997 .....	228
	Y60 GQ Coil Cab 1987 to 1997 .....	228

## RAM

1500	DT 6/2018+ .....	239
	DS 2014 to 2019 .....	238

## RENAULT

Alaskan	Thai-Built Only 2017+ .....	240
---------	-----------------------------	-----

## SSANGYONG

Musso	Q200 10/2018+ .....	243
	Q201 10/2018+ .....	243
	Q205 10/2018+ .....	243
	Q215 10/2018+ .....	243
Rexton	Y400 10/2018+ .....	248

## SUZUKI

Jimny	GJ 2018+ .....	254
	2012 to 1/2019 .....	256
Grand Vitara	8/2005 to 2015 .....	260

## TOYOTA

4Runner	Gen 5, N280 2009+ .....	264
FJ Cruiser	2006+ .....	270
Fortuner	2015+ .....	272
	2004 to 2015 .....	274
Hilux	8/2020+ .....	278
	Revo 5/2018 to 7/2020 .....	282
	Revo 2015 to 4/2018 .....	282
	Vigo 2011 to 2015 .....	286
	Vigo 2005 to 2011 .....	286
	Tiger 1997 to 2004 .....	290
Landcruiser	200 Series (Facelift) 11/2015+ .....	295
	200 Series 2/2012 to 10/2015 .....	298
	200 Series 11/2007 to 1/2012 .....	298
	105 Series HZJ105, FZJ105	
	Live Axle Front Suspension 3/1998 to 10/2007 .....	300
	100 Series HDJ100, UZJ100	
	Independent Front Suspension 3/1998 to 10/2007 .....	303
	80 Series HZJ80, FZJ80 1990 to 1998 .....	305
	79 Series (V8 TD) Single Cab 9/2016+ .....	308
	79 Series (V8 TD) Single Cab 2007 to 8/2016 .....	308
	79 Series Single Cab 1999 to 2007 .....	308
	79 Series Dual Cab 11/2012+ .....	311
	78 Series Troop Carrier 2007+ .....	315
	78 Series 1999 to 2007 .....	319
	76 Series 2007+ .....	323
	75 Series 1984 to 1999 .....	326
	60 Series 11/1980 to 11/1989 .....	332

## TOYOTA - Continued

Prado	150 Series (Facelift) 11/2017+ .....	340
	150 Series 11/2013 to 10/2017 .....	343
	150 Series 11/2009 to 10/2013 .....	343
	120 Series 4/2003 to 10/2009 .....	346
	95 Series 1996 to 10/2002 .....	348
	90 Series 1996 to 10/2002 .....	348
Tacoma	2005+ .....	350
Tundra	2013 to 2020 .....	352

## VOLKSWAGEN

Amarok	V6 11/2016+ .....	358
	2011 to 10/2016 .....	360

## SPARE PARTS

Bull Bars	.....	364
Canopies	.....	365
Canopy / Roof Racks	.....	368
Driving Lights	.....	368
Fridges	.....	368
Instant Awnings	.....	369
Miscellaneous	.....	372
Rooftop Tents	.....	369
Slide-Away Tonneau Covers	.....	370
Snorkels	.....	370
Suspension	.....	370
Swags	.....	371
Tow Bars	.....	371
Underbody Protection	.....	371
Winches	.....	371

## ACCESSORY INSTALLATION FITTING TIMES

Approximate Accessory Fitting Times	.....	373
-------------------------------------	-------	-----

## ACCESSORIES PRODUCT INFORMATION

Features and Benefits	.....	434
-----------------------	-------	-----

## ACCESSORIES TECHNICAL SPECIFICATIONS

Monster Winches	.....	440
Bull Bars	.....	440
Rear Tow Bars	.....	438
Side Steps / Rails	.....	438
Rated Recovery Points	.....	438
Snorkels	.....	444
Underbody Protection	.....	445
Roof Racks and Accessories	.....	446
Canopies	.....	447
Driving Lights	.....	448
LED Worklights	.....	449
LED Light Bars	.....	450
Fridge / Freezers	.....	452
Fridge / Freezer Troubleshooting	.....	452
Locksafe Drawer Systems	.....	454
DeltaWing 270° Awnings	.....	455
Rooftop Tents	.....	456
Rooftop Tent and Awning Accessories	.....	458
Swags	.....	459
Water Tanks	.....	460

## QUICK REFERENCE INDEX

Product Code Reference	.....	461
------------------------	-------	-----

## TERMS AND CONDITIONS

Terms and Conditions of Trade	.....	482
-------------------------------	-------	-----

# Contents - Suspension to Suit

## SUSPENSION TO SUIT (BY VEHICLE)

<b>DACIA</b>	
Duster	2010+ ..... 44
<b>FIAT</b>	
Fullback	2016+ ..... 46
<b>FORD</b>	
Courier	Ranger (not USA model) 1985 to 2006 ..... 66
Everest	UA11 7/2018+ ..... 68
	3.2L 2015 TO 6/2018 ..... 70
Maverick	1988 to 1994 (See Nissan Patrol Page 229) ..... 229
Ranger	Raptor 9/2018+ ..... 51
	PX Mk III (not USA model) 7/2018+ ..... 54
	PX Mk II (not USA model) 2015 to 6/2018 ..... 58
	T6 PX (not USA model) 2011 to 2015 ..... 62
	PJ / PK (not USA model) 3/2006 to 2011 ..... 65
<b>GM / Holden</b>	
Colorado	RG 2016 to 2020 ..... 81
	RG 2012 to 2016 ..... 84
	RG Low Ride 2WD 2012+ ..... 86
	RC 2003 to 2012 ..... 88
Colorado 7	Trailblazer 2012+ ..... 79
Frontera	1995 to 1/1999 ..... 75
Jackaroo	Bighorn / Monterey 1992+ ..... 72
	11/1986 to 1991 ..... 73
	Pre 1996 ..... 74
Rodeo	RA 2003 to 2012 ..... 90
	RA7 2003 to 2012 ..... 90
	KB - TFS 1988 to 3/2003 ..... 92
	KB - TF 1983 to 1988 ..... 93
Trailblazer	LT / LTZ 2017+ ..... 77
<b>GREAT WALL UTE</b>	
Cannon	9/2020+ ..... 94
<b>HAVAL</b>	
H9	Wagon 2.0L Petrol 8/2017+ ..... 95
<b>HYUNDAI</b>	
Terracan	2001+ ..... 97
<b>ISUZU</b>	
D-Max	8/2019+ ..... 99
	2016 to 7/2019 ..... 102
	6/2012 to 1/2017 ..... 105
	Low Ride 2WD 2012+ ..... 107
	2003 to 2012 ..... 109
MU-X	2013+ ..... 111
Trooper	1992+ ..... 112
	11/1986 to 1991 ..... 113
	Pre 1986 ..... 114
<b>JEEP</b>	
Cherokee	Liberty KK 2007 to 2012 ..... 115
	Liberty KJ 2001 to 2006 ..... 116
	XJ 1984+ ..... 117
Gladiator	JT 2019+ ..... 119
Grand Cherokee	WK2 (4x4) 2011+ ..... 121
	WJ / WG 1999 to 6/2005 ..... 122
	ZJ / ZG 1993 to 1998 ..... 123
Wrangler	JL 2018+ ..... 125
	JK 2006+ ..... 127
	TJ 1996 to 2/2007 ..... 128
<b>JMC</b>	
Vigus	2014+ ..... 129
<b>KIA</b>	
Sorento	BL 2003 to 2008 ..... 130
<b>LADA</b>	
Niva	1978+ ..... 131
<b>LAND ROVER</b>	
Defender	110 Series County / Dual Cab ..... 134
	130 Series County / Dual Cab ..... 134
	110 Series Trayback ..... 135
	90 Series ..... 136
Discovery	Series 3 LR3 (Coil Springs) 2004 to 2009 ..... 139
	Series 2 (Coil Springs) 1999 to 2005 ..... 140
	Series 1 1989 to 2005 ..... 141
Range Rover	(Coil Springs) 1971 to 1995 ..... 137
<b>LDV</b>	
T60	2.8L Turbo Diesel 2017+ ..... 142
<b>MAHINDRA</b>	
Scorpio	Getaway Pik-Up 2002 to 2016 ..... 144
	Wagon 2002 to 2014 ..... 145
<b>MAZDA</b>	
BT50	6/2020+ ..... 148
	2011 to 5/2020 ..... 152
	2006 to 2011 ..... 155
B Series Bravo	1987 to 2006 ..... 158
<b>MERCEDES BENZ</b>	
G-Wagen	W460, W461 W463 1979+ ..... 158
	G55 AMG ..... 159
Unimog	UL1700, 2450, U5000, 1300, 1550, U4000 ..... 160
X-Class	4 Cyl Models 2017 to 5/2020 ..... 161
<b>MITSUBISHI</b>	
Challenger Montero Sport	PA (Coil) 1998 to 2008 ..... 175
	PA (Leaf) 1998 to 2006 ..... 176
Delica	L400 1994+ ..... 177
Pajero	Montero NM - NX 2000+ ..... 168
	iO Pinin 1999+ ..... 169
	Montero NH - NL (Coil) 6/1991 to 2000 ..... 170
	Montero NH - NL (Leaf) 1991 to 1999 ..... 171
	Montero NA - NG (Coil) 1988 to 1991 ..... 172
	Montero NA - NG (Leaf) Pre 1991 ..... 173
Pajero Sport	7/2019+ ..... 163
	2.4L Mivec 2015 to 6/2019 ..... 165
Pajero Sport / Montero Sport / Dakar	PB 2009 to 2015 ..... 174
Triton	MR 11/2018+ ..... 180
	MQ L200 2015 to 10/2018 ..... 184
	MN L200 2009 to 2015 ..... 188
	ML L200 2006 to 2009 ..... 191
	MK L200 1996 to 2006 ..... 193
	ME-MJ 1993 to 1996 ..... 194
	L200 Pre 1983 ..... 195



# Contents - Suspension to Suit

## NISSAN

Navara	NP300 (Coil Springs) 2021+ Series 5.....	198
	NP300 (Leaf Springs) 2021+ Series 5.....	199
	NP300 (Coil Springs) 2015 to 2020 Series 1 to 5 .....	201
	NP300 (Leaf Springs) 2014 to 2020 Series 1 to 5 .....	202
	D40 (V6 Diesel) 2005+ .....	204
	D40 (4cyl Diesel and V6 Petrol) 2005+.....	205
	D22 / NP300 (Torsion Bar) 1997+.....	207
	D21 1985 to 1996 .....	208
Paladin	Pre 2005 .....	209
Pathfinder	R51 (V6 Diesel) 7/2005+ .....	211
	R51 (4cyl Diesel and V6 Petrol) 7/2005+.....	213
	R50 1995 to 7/2005 .....	214
	R20 Pre 1995 .....	215
Patrol	Y62 2010+ .....	217
	Y61 GU LWB Wagon.....	220
	Y60 GQ Cab Chassis (Coil / Coil) .....	224
	Y61 GU Cab Chassis (Coil / Coil).....	224
	Y60 GQ Cab Chassis (Coil / Leaf) .....	227
	Y61 GU Cab Chassis (Coil / Leaf).....	227
	Y60 GQ Cab Chassis (Leaf / Leaf) 1988+ .....	229
	Y60 GQ LWB Wagon 1988 to 1998.....	230
	Y60 GQ SWB Wagon 1988 to 1998 .....	232
	MK G160 (Rectangle Headlights) 1984+ .....	234
	MQ G160 (Round Headlights) Pre 1984.....	235
Terrano/II WD21	Pre 1995 .....	215
Xterra	2005+.....	236
Xtrail	T30 2001 to 9/2007 .....	237

## RAM

1500	DT 6/2018+ .....	238
	DS 2014 to 2019.....	239

## RENAULT

Alaskan	2017+ .....	241
Duster	2010+.....	242

## SSANGYONG

Korando	1996 to 2006 .....	247
Musso	Q200 SWB 10/2018+ .....	244
	Q201 LWB (Coil) 10/2018+ .....	245
	Q215 LWB (Coil) 10/2018+ .....	245
	Q201 LWB (Leaf) 10/2018+.....	246
	Q205 LWB (Leaf) 10/2018+.....	246
	Q215 LWB (Leaf) 10/2018+ .....	246
	1996 to 2006 .....	247
Rexton	Y400 2018+ .....	249
	Y450 2018+ .....	249

## SUBARU

Forester	2019+.....	250
	SF5, GX, RX, GT 1997 to 2013 .....	251
Outback	2015+.....	252
XV	2018+.....	253

## SUZUKI

Grand Vitara	8/2005 to 2015 .....	261
	1988 to 7/2005 .....	262
Jimny	GJ 2018+.....	255
	SN413 1998 to 2018.....	257
Sierra	SJ80 (Coil) 1997+ .....	258
	Samurai LJ, SJ (Leaf) 1981+ .....	259
Vitara	1988+.....	263

## TOYOTA

4Runner	Gen 4 and 5, N210 - N280 2003+ .....	265
	Gen 3 N180 - N185 1996 to 2002 .....	266
	Gen 2 Surf N130 V6 (Coil) 1990 to 1997 .....	267
	Gen 1 N60 (Leaf) 1988 to 1997 .....	268
Bundera	1984 to 1989 .....	329
FJ Cruiser	2006+.....	271
Fortuner	2015+.....	272
	2004 to 2015 .....	275
Hiace	Series 300 2019+ .....	276
	Series 200 2005 to 2019.....	277
Highlander	2020+.....	282
Hilux	8/2020+.....	280
	Revo 2015 to 7/2020.....	284
	Vigo 3/2005 to 9/2015 .....	287
	Low Ride 2WD 2005+ .....	289
	Tiger 107, 108, 110, 111 167 1997 to 2005 .....	291
	Solid Front Axle 11/1983 to 11/1997 .....	292
	Solid Front Axle 1979 to 10/1983 .....	293
Kluger	2020+.....	294
Landcruiser	200 Series (Facelift) 11/2015+ .....	296
	200 Series 11/2007 to 10/2015+ .....	299
	105 Series 1998+ .....	301
	100 Series, IFS 1998+.....	304
	80 Series 1990+ .....	306
	79 Series Single Cab 1999+ .....	309
	79 Series Dual Cab 2013+ .....	312
	78 Series 2007+ .....	316
	78 Series 1999 to 2007 .....	320
	76 Series 2007+ .....	324
	75 Series 1984 to 1999.....	327
	71 Series (Coil / Leaf) 1999+.....	330
	70, 73, 74 Series (Leaf / Leaf) 1984 to 1988.....	331
	60 Series 1986+ .....	332
	60 Series Pre 1986.....	334
	45, 47 Series 8/1980 to 1985.....	336
	45 Series 1960 to 1980.....	337
	40, 42, 46 Series 1980 to 1984 .....	338
	40 Series 1960 to 1980.....	339
Prado	150 Series (Coil) 12/2017+ .....	341
	150 Series (Coil) 2009 to 11/2017 .....	344
	120 Series 4/2003 to 10/2009 .....	346
	90, 95 Series 1996 to 10/2002.....	349
	II Prado 70, 73, 78 Series 1990 to 1996.....	328
Rav4	2019 to 2021 .....	269
Tacoma	2005+.....	351
Tundra	2006 to 2021 .....	353
<b>TROLLER</b>		
T4	7/2014+.....	354
	1997 to 6/2014 .....	355
<b>UAZ</b>		
Hunter	All Models .....	356
Patriot	1997+.....	357
<b>VOLKSWAGEN</b>		
Amarok	V6 / 4 Cyl 11/2016+.....	359
	1997 to 10/2016 .....	361
<b>SPARE PARTS</b>		
Suspension	.....	370



# Contents - Suspension to Suit

## ACCESSORY INSTALLATION FITTING TIMES

Approximate Accessory Fitting Times .....373

## GVM UPGRADES TO SUIT (BY VEHICLE)

Ranger	PX Mk III (not USA model) 7/2018+.....	378
	PX Mk II (not USA model) 2015 to 6/2018 .....	379
	T6 PX (not USA model) 2011 to 2015.....	379
Colorado	RG 2016 to 2020.....	380
	RG 2012 to 2016.....	380
D-Max	MY20+.....	381
	6/2012 to 7/2019 .....	382
BT50	6/2020+.....	383
Jimny	GJ 2018+.....	384
Hilux	8/2020+.....	385
	Revo 2015 to 4/2018.....	385
	Vigo 3/2005 to 2015.....	386
Landcruiser	200 Series MC NA 2007+.....	387
	79 Series Single Cab 2007+.....	388
	79 Series Dual Cab 2012+ .....	389
	78 Series Troop Carrier 2007+ .....	390

## SUSPENSION PART SELECTION

Understanding Load .....	392
Determining Load .....	393
Understanding Terrain.....	394
Understanding Valving .....	395
Understanding GVM Upgrades.....	396
Suspension Kit Selection.....	397
Shock Absorber Application Guide.....	398
Features and Benefits .....	402
Load Plus Helper Springs Application Guide .....	406

## SUSPENSION TECHNICAL SPECIFICATIONS

Installation Times.....	410
Installation Form .....	411
Coil Springs Technical Specifications .....	412
Leaf Springs Technical Specifications.....	415
Torsion and Sway Bars Technical Specifications.....	417
Shock Absorbers - Nitro Gas Technical Specifications .....	418
Shock Absorbers - Foam Cell Technical Specifications .....	420
Shock Absorbers - Foam Cell Pro Technical Specifications .....	421
Steering Dampers Technical Specifications .....	424
Shock Absorber Mount Types Technical Specifications .....	425
Trim Packers Technical Specifications.....	426
U-Bolts Technical Specifications.....	427
Load Plus Helper Springs Technical Specifications .....	427
Suspension Rubber Arm Bush Kits Technical Specifications .....	428
Strut Compressor.....	429
FAQ / Troubleshooting .....	430

## QUICK REFERENCE INDEX

Product Code Reference .....	461
------------------------------	-----

## TERMS AND CONDITIONS

Terms and Conditions of Trade .....	482
-------------------------------------	-----

# **4WD and Touring Gear**

**CATALOGUE AND PRICE LIST**

*Effective 1 November 2021*



# Recovery

Product Description

Part No.

Retail  
ea Inc GST

**ELECTRIC WINCHES**

<b>A</b> Monster Winch 9500lb - 12V (With Steel Cable)	<b>WWB9500</b>	\$885.00
<b>B</b> Monster Winch 12000lb - 12V (With Steel Cable)	<b>WWB12000</b>	\$997.00
<b>C</b> Monster Winch 9500lb - 12V (With Synthetic Rope)	<b>WWB9500SR</b>	\$1112.00
<b>D</b> Monster Winch 12000lb - 12V (With synthetic rope)	<b>WWB12000SR</b>	\$1223.00

**WINCH ACCESSORIES**

<b>E</b> Synthetic Winch Rope - 9.5mm x 27m (8100kg)	<b>WWWROPE001</b>	\$491.00
<b>F</b> Winch Damper Blanket	<b>WINCH BLANKET</b>	\$39.00
<b>G</b> Alloy Hawse Fairlead	<b>WWWHAWSE</b>	\$85.00

**RECOVERY KITS**

<b>H</b> Small Recovery Kit	<b>IRECKIT004</b>	\$181.00
<b>I</b> Large Recovery Kit	<b>IRECKIT003</b>	\$376.00

**TECHNICAL DIMENSIONS AND SPECIFICATIONS  
SEE PAGE 440**





# Recovery

Product Description

Part No.

Retail  
ea Inc GST

**RECOVERY STRAPS AND ACCESSORIES**

<b>A</b> Universal Recovery Hook - 4500kg Rating	<b>ITOW</b>	\$26.00
<b>B</b> Recovery Hitch - 4.75t Rating (With bow shackle)	<b>IHOOK BOW</b>	\$67.00
<b>C</b> Bow Shackle - 4.75t Rating	<b>IBOW</b>	\$18.00
<b>D</b> Snatch Block - 8000kg Rating	<b>IBLOCK</b>	\$67.00
<b>E</b> Heavy Duty Drag Chain (5m x 8mm)	<b>IDRAG</b>	\$101.00
<b>F</b> Leather Recovery Gloves	<b>IGLOVES</b>	\$15.00
<b>G</b> Soft Shackle - 14000kg (500mm x 12mm)	<b>ISOFSHA001</b>	\$52.00
<b>H</b> Soft Shackle- 17500kg (500mm x 12mm)	<b>ISOFSHA002</b>	\$63.00
<b>I</b> Recovery Rope - 9500kg (9m x 22mm)	<b>ISNATCHROPE</b>	\$188.00
<b>J</b> Snatch Strap - 8000kg (9m x 75mm)	<b>ISNATCH005</b>	\$90.00
<b>K</b> Snatch Strap - 11000kg (9m x 100mm)	<b>ISNATCH006</b>	\$120.00
<b>L</b> Tree Trunk Protector - 12000kg (3m x 75mm)	<b>ITREE</b>	\$55.00
<b>M</b> Winch Extension Strap - 4500kg (20m x 50mm)	<b>IWINCHEXT</b>	\$79.00
Large Recovery / Accessory Bag	<b>IRECKIT001 BAG</b>	\$34.00
Small Recovery / Accessory Bag	<b>IRECKIT002 BAG</b>	\$21.00



# Recovery

Product Description

Part No.

Retail  
ea Inc GST

**COMPRESSORS**

<b>A</b> Air Champ Compressor - 12V (90L/min)	<b>ICOMPRESSOR003</b>	\$165.00
<b>B</b> Air Champ Pro Compressor - 12V (160L/min)	<b>ICOMPRESSOR004</b>	\$220.00

**TYRE ACCESSORIES**

<b>C</b> Speedy Deflator with Gauge	<b>ISPEEDY</b>	\$83.00
<b>D</b> Air Champ Smart Deflator with Gauge	<b>ITYRE005</b>	\$68.00
<b>E</b> Air Champ Compact Deflator	<b>ITYRE004</b>	\$41.00
<b>F</b> Air Champ Pressure Gauge	<b>ITYRE006</b>	\$41.00
<b>G</b> Air Champ Dual Inflator Air Champ Extension Hose to suit Dual Inflator	<b>ITYRE007</b>	\$97.00
	<b>ITYRE008</b>	\$34.00
<b>H</b> Tyre Repair Kit	<b>ITYRE001</b>	\$82.00
<b>I</b> Tyre Repair Cord (Refill 25pc)	<b>ITYRE002</b>	\$20.00

**LIFTING JACKS**

<b>J</b> 4WD Lift Jack - 48" (Includes cover)	<b>IHIGHLIFT001</b>	\$184.00
<b>K</b> 4WD Lift Jack - 60" (Includes cover)	<b>IHIGHLIFT002</b>	\$209.00
<b>L</b> Tyre Lift Kit	<b>IHIGHLIFT004</b>	\$82.00
<b>M</b> Bumper Lift Kit	<b>IHIGHLIFT003</b>	\$37.00

**DIFF BREATHER KIT**

<b>N</b> Diff Breather Kit	<b>IDIFFBRE</b>	\$115.00
----------------------------	-----------------	----------





# Recovery

Product Description

Part No.

Retail  
ea Inc GST

**RECOVERY BOARDS**

<b>A</b>	Reco-Traks - Sand (Pair)	IRECBRDSAND	\$229.00
<b>B</b>	Reco-Traks - Grey (Pair)	IRECBRDGREY	\$229.00
<b>C</b>	Reco-Traks - Green (Pair)	IRECBRDGREEN	\$229.00
<b>D</b>	Recovery Tracks by TREDs - <i>While Stocks Last</i>	ITREDS1100	\$199.00
<b>E</b>	Recovery Board Mounting Base	IRECBRDBASE	\$23.00
<b>F</b>	Recovery Board Mount Pins 110mm (Pair)	IRECBRDPINS115	\$28.00
<b>G</b>	Recovery Board Leash (Pair)	IRECBRDLEASH	\$21.00

**ANCHOR TRACKS**

<b>H</b>	610mm Anchor Track	ITRACK610	\$52.00
<b>I</b>	305mm Anchor Track	ITRACK305	\$36.00
<b>J</b>	Additional Rings - Twin Pack (2 Rings)	ITRACKRING	\$6.00

**MULTI-PURPOSE REAR WHEEL BAG**

<b>K</b>	Rear Wheel Bag	IRWB001	\$91.00
----------	----------------	---------	---------

**SEAT COVERS**

<b>L</b>	Universal Slip-On Seat Cover	ISEAT COVER	\$29.00
----------	------------------------------	-------------	---------

**AIRBAG COMPATIBLE CANVAS SEAT COVERS**

<b>M</b>	Vehicle Specific Fitted Seat Cover - Front	See Vehicle Listing	\$401.00
<b>N</b>	Vehicle Specific Fitted Seat Cover - Rear	See Vehicle Listing	\$401.00

**HI VIS SAND FLAG**

<b>N</b>	1m, 2m or 3m Length	IHVFLAG	\$150.00
----------	---------------------	---------	----------





# Camping Accessories

Product Description	DATE AVAILABLE	Part No.	Retail ea Inc GST
<b>CAMP CHAIRS</b>			
<b>A</b> Low Back Quad Fold Camp Chair	Q1 2022	ICHAIR0034	\$50.00
<b>B</b> Club Lounge Quad Fold Camp Chair	Q1 2022	ICHAIR0045	\$95.00
<b>C</b> King Quad Camp Chair - With Lumbar Support	Q1 2022	ICHAIR0056	\$81.00
<b>D</b> King Hard Arm Camp Chair - With Lumbar Support	Q1 2022	ICHAIR0067	\$95.00
<b>E</b> Mid Size Low Back Camp Chair (130kg rated) - <i>While Stocks Last</i>		ICHAIRMS	\$50.00
<b>F</b> Deluxe Lounge Camp Chair (150kg rated) - <i>While Stocks Last</i>		ICHAIRL003	\$97.00
<b>G</b> Deluxe Soft Arm Camp Chair (150kg rated) - <i>While Stocks Last</i>		ICHAIRSA005	\$73.00
<b>H</b> Deluxe Hard Arm Camp Chair (150kg rated) - <i>While Stocks Last</i>		ICHAIRHA004	\$86.00
<b>CAMP TABLES</b>			
<b>I</b> Multi-Use Side Camp Table	Q1 2022	ITABLE0012	\$46.00
<b>J</b> Aluminium Camp Table - Adjustable Height	Q4 2021	ITABLE0023	\$134.95
<b>PET COMFORT</b>			
<b>K</b> Quick Fold Dog Bed with Padded Mat (80 x 80 x 25cm)	Q1 2022	IPET0023	\$70.00



# Camping Accessories

Product Description

DATE AVAILABLE

Part No.

Retail  
ea Inc GST

**CAMP SLEEPING**

<b>A</b> -5° Swag Bag Sleeping Bag		ISWAGBAG	\$169.00
<b>B</b> Quick-Fold Camp Stretcher (150kg rated)		IQFS001	\$154.00

**CAMP SWAGS**

<b>C</b> King Single - Ridge Pole Style	Q1 2022	ISWAG0023	\$439.00
<b>D</b> Double - Ridge Pole Style	Q1 2022	ISWAG0034	\$479.00
<b>E</b> Single Swag - <i>While Stocks Last</i>		ISWAG001	\$405.00
<b>F</b> Double Swag - <i>While Stocks Last</i>		ISWAG002	\$459.00



**SWAGS TECHNICAL DIMENSIONS SEE PAGE 459**





# Camping Accessories

Product Description

Part No.

Retail  
ea Inc GST

**CAMP GEAR**

<b>A</b> Quick-Fold Camping Steps (180kg rated)	<b>IQFSTEP</b>	\$61.00
<b>B</b> Foldable Bush Toilet (200kg rated)	<b>IBUSHTOILET</b>	\$115.00
<b>C</b> Bush Toilet Replacement Biodegradable Bags (10 per pack)	<b>IBTBAGS</b>	\$15.00
<b>D</b> 12L Ezy-Go Flushing Toilet	<b>ITOILET12</b>	\$161.00
<b>E</b> Ezy-Go Flush Aid Part A & B (Sold together as 2 part kit)	<b>ITOILETA+B</b>	\$25.00
<b>F</b> 15L Gravity Solar Shower	<b>ISHOWER003</b>	\$33.00
<b>G</b> 12L Pressure Shower	<b>ISHOWER004</b>	\$101.00
<b>H</b> Rechargeable Portable Shower - Lithium	<b>ISHOWER001</b>	\$80.00
<b>I</b> Eco Pressure Shower (Includes carry bag) - <i>While Stocks Last</i>	<b>ISHOWER002</b>	\$95.00





# Camping Accessories

Product Description	DATE AVAILABLE	Part No.	Retail ea Inc GST
<b>CAMP KITCHEN</b>			
<b>A</b> 12V Portable Oven with Racks and Tray	Q4 2021	IOVEN0012	\$299.00
<b>B</b> Collapsible Bin with Lid - 8L	Q4 2021	IBIN0012	\$20.00
<b>C</b> Collapsible Bucket with Handle - 10L	Q4 2021	IBUCKET0012	\$20.00
<b>D</b> Collapsible Washing Tub - 8.5L	Q4 2021	ITUB0012	\$20.00
<b>E</b> Collapsible Dish Rack with Tray - 8.5L	Q4 2021	IDISH0012	\$20.00
<b>F</b> Collapsible Storage Tub with Lid - 30L	Q4 2021	ISTORE0012	\$46.00
<b>G</b> Collapsible Storage Tub with Lid - 45L	Q4 2021	ISTORE0023	\$55.00
<b>H</b> Collapsible Silicone Kettle - Food Grade (1.5L)		IKETTLE001	\$64.00
<b>CAMP TOOLS</b>			
<b>I</b> 3 Piece Shovel (Incl. Carry Bag)		ISHOVEL001	\$162.00
<b>J</b> 2.0Kg (4.4lb) Axe Splitter		IAXE001	\$78.00
<b>K</b> 0.7Kg (1.5lb) Axe		IAXE002	\$24.00
<b>L</b> Tent Peg Mallet		IMALLET	\$21.00
<b>CLEANING</b>			
<b>M</b> 500ml Gritty Hand Wash (Box of 6 only)		IHCLEAN BOX	\$72.00
500ml Gritty Hand Wash (RRP only)		IHCLEAN	\$14.00



# Camp Lighting

Product Description

DATE AVAILABLE

Part No.

Retail  
ea Inc GST

**LIGHTING**

<b>A</b> LED Area Light		IARELED001	\$119.00
<b>B</b> LED Area Light Tripod Stand		IARETRIPOD	\$29.00
<b>C</b> LED Lantern / Torch		ILANTERN001	\$42.00
<b>D</b> Mini LED Lantern		ILANTERN002	\$44.00
<b>E</b> LED Lantern		ILANTERN003	\$38.00
<b>F</b> LED Worklight Combo		ILEDWLC	\$72.00
<b>G</b> Rechargeable LED Lantern and Bug Zapper	Q1 2022	ILANTERN004	\$49.00
<b>H</b> Rechargeable Hi-Flow Tent Fan and LED Light	Q1 2022	ITENTFAN003	\$59.00
<b>I</b> LED Tent Light / Fan		ITENTFAN002	\$39.00
<b>J</b> LED Tent Light		ITENTLIGHT002	\$17.00
<b>K</b> LED Sensor Headlamp		IHEADLAMP002	\$38.00
<b>L</b> Awning 12V LED Sail Track Light Strip and Dimmer Set		IAWNINGPART006	\$58.00
<b>M</b> LED Light Strip (Includes switch)		ILEDSTRIP	\$56.00
<b>N</b> LED Dimmer		ILEDDIMMER	\$20.00



# Camp Lighting / Power

Product Description	DATE AVAILABLE	Part No.	Retail ea Inc GST
<b>CAMPING POWER</b>			
<b>A</b> 120W Solar Panel Kit		ISOLAR120	\$649.00
<b>B</b> 200W Solar Panel Kit		ISOLAR200	\$850.00
<b>C</b> Portable Battery Box with DC Outlets		IBATTBOX0012	\$100.00
<b>D</b> Titan 500 Power Station 51Ah (220-240Vac) - Aust Only	Q1 2022	IPOWER0012	\$999.00
<b>E</b> Titan 500 Power Station 51Ah (100-120Vac) - USA Only	Q1 2022	IPOWER0023	-
<b>F</b> Titan 500 Power Station 51Ah (220-240Vac) - International Only*	Q1 2022	IPOWER0034	-

\*Includes AC Plug Adaptor





# Fridge / Freezers

Product Description

Part No.

Retail  
ea Inc GST

**FRIDGE / FREEZERS**

<b>A</b>	30L Fridge / Freezer	IFRIDGE30	\$765.00
<b>B</b>	40L Fridge / Freezer	IFRIDGE40	\$841.00
<b>C</b>	50L Fridge / Freezer	IFRIDGE50	\$926.00
<b>D</b>	65L Fridge / Freezer	IFRIDGE65	\$1366.00
<b>E</b>	74L Fridge / Freezer	IFRIDGE74	\$1260.00

**TECHNICAL DIMENSIONS, SPECIFICATIONS AND FRIDGE TROUBLESHOOTING - SEE PAGE 452**



**SECOP Compressor**

- German engineered
- Low energy consumption
- Electronically controlled

# Fridge / Freezer Accessories

Product Description	DATE AVAILABLE	Part No.	Retail ea Inc GST
<b>FRIDGE / FREEZER SLIDES</b>			
<b>A</b> Fridge Slide - 30L, 40L, 50L (Inc. 4 x straps)		IFRIDGESLIDE001	\$270.00
<b>B</b> Fridge Slide - 65L, 74L (Inc. 4 x straps)		IFRIDGESLIDE002	\$373.00
<b>C</b> Fridge Slide - 30 to 50L - Tilt (Inc. 4 x straps)	Q1 2022	IFRIDGESLIDE034	\$359.00
<b>D</b> Fridge Slide - 65 to 70L - Tilt (Inc. 4 x straps)	Q1 2022	IFRIDGESLIDE045	\$459.00
<b>FRIDGE / FREEZER ACCESSORIES (BAGS SOLD SEPARATELY)</b>			
<b>E</b> 30L Fridge Bag		IFRIDGE30 BAG	\$104.00
<b>F</b> 40L Fridge Bag		IFRIDGE40 BAG	\$104.00
<b>G</b> 50L Fridge Bag		IFRIDGE50 BAG	\$108.00
<b>H</b> 65L / 74L Fridge Bag		IFRIDGE 65 74 BAG	\$136.00
<b>I</b> Fridge Straps		IFRIDGE STRAPS	\$31.00
<b>J</b> Wireless LCD Fridge Thermometer		IWFT001	\$31.00
<b>K</b> Fridge Stand		IFRIDGESTAND001	\$55.00

**FRIDGE SLIDE TECHNICAL DIMENSIONS  
SEE PAGE 453**

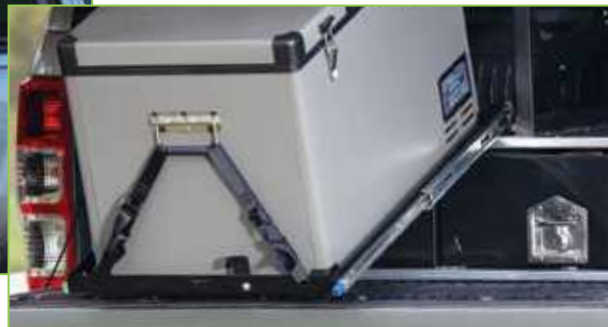



# Camping

Product Description

Part No.

Retail  
ea Inc GST

**ROOFTOP TENTS**

<b>A</b> Soft Rooftop Tent	<b>IROOFTENT TENT</b>	\$1485.00
<b>B</b> Swift 1400 Rooftop Tent - Aluminium Hardtop	<b>IRTT0012</b>	\$3499.00
<b>C</b> Nomad 1300 Rooftop Tent - ABS Hardtop	<b>IRTT0023</b>	\$3499.00

**ROOFTOP TENT AWNINGS AND ANNEX**

<b>D</b> Soft Rooftop Tent - Annex	<b>IROOFTENT ANNEX</b>	\$357.00
Nomad 1300 Rooftop Tent - Front Extension Awning Kit	<b>IRTTAWN0023</b>	\$285.00

**ACCESSORIES**

<b>E</b> Rooftop Tent - Sail Track Hanging Bag	<b>ITENTBAG001</b>	\$40.00
<b>F</b> Soft Rooftop Tent - Annex Extension Kit (Room 200mm)*	<b>IROOFTENT003</b>	\$77.00
<b>G</b> Soft Rooftop Tent Ladder Extension Kit (500mm)*	<b>IROOFTENT002</b>	\$70.00

\* Required for tent bases sitting above 1.8m from ground.

**ROOFTOP TENTS DIMENSIONS - SEE PAGE 456**





# Camping





# Camping

Product Description

Part No.

Retail  
ea Inc GST

**DELTAWING AWNINGS AND ACCESSORIES**

<b>A</b> DeltaWing 270 XTR-143 Awning (LHS) Unsupported - 2.0m (L) *	<b>IAWN270L012</b>	\$999.00
DeltaWing 270 XTR-143 Awning (RHS) Unsupported - 2.0m (L) *	<b>IAWN270R012</b>	\$999.00
<b>B</b> DeltaWing 270 XTR-71 Awning (LHS) Unsupported - 2.0m (L)	<b>IAWN270L023</b>	\$899.00
DeltaWing 270 XTR-71 Awning (RHS) Unsupported - 2.0m (L)	<b>IAWN270R023</b>	\$899.00
<b>C</b> DeltaWing 270 XT-71 Awning (LHS) Supported - 2.0m (L)	<b>IAWN270L034</b>	\$549.00
DeltaWing 270 XT-71 Awning (RHS) Supported - 2.0m (L)	<b>IAWN270R034</b>	\$549.00

\* Includes additional Awning Wall as a standard

• All include inclement weather stabilisation poles and guy ropes

**DELTAWING 270° AWNINGS  
DIMENSIONS - SEE PAGE 455**





# Camping

Product Description

Part No.

Retail  
ea Inc GST

**DELTAWING AWNING ACCESSORIES**

<b>D</b> DeltaWing 270 XTR-143 Awning Wall Kit (LHS) - 3 Piece (suits IAWN270L012)	<b>IAWNWALL27012</b>	\$449.00
DeltaWing 270 XTR-143 Awning Wall Kit (RHS) - 3 Piece (suits IAWN270R012)	<b>IAWNWALL27045</b>	\$449.00
<b>E</b> DeltaWing Awning Wall Kit - 2 Piece Door and Wall	<b>IAWNWALL27023</b>	\$299.00
<b>F</b> DeltaWing Awning Wall Kit - 2 Piece Wall Only	<b>IAWNWALL27034</b>	\$299.00
<b>G</b> Awning Camp Organiser	<b>IAWNORG012</b>	\$69.00
<b>H</b> DeltaWing 270 XTR-143 and 270 XTR-71 Awning LED Light Kit	<b>IAWNLED270012</b>	\$99.00





# Camping

Product Description

Part No.

Retail  
ea Inc GST

**INSTANT AWNINGS AND ACCESSORIES**

<b>A</b> Instant Awning 1.4m (L) x 2.0m (Out) (Inc. Brackets and LED Strip)	<b>IAWNING1.4M</b>	\$261.00
Instant Awning 2m (L) x 2.5m (Out) (Inc. Brackets and LED Strip)	<b>IAWNING2M</b>	\$288.00
Instant Awning 2.5m (L) x 2.5m (Out) (Inc. Brackets and LED Strip)	<b>IAWNING2.5M</b>	\$314.00
<b>B</b> Awning Xtra Weathershield (Suits 2m Wide Awning) - 2m A x 2.4m B x 1.4m C	<b>IAWNING2MWALL</b>	\$160.00
Awning Xtra Weathershield (Suits 2.5m Wide Awning) - 2m A x 2.4m B x 1.4m C	<b>IAWNING2.5MWALL</b>	\$187.00
<b>C</b> Awning Quick Release Bracket Kit	<b>IAWNINGQQR</b>	\$145.00
Awning Quick Release Extra Hooks Kit	<b>IAWNINGQQR HOOK</b>	\$70.00
<b>AWNING ROOMS, ENCLOSURES AND ACCESSORIES</b>		
<b>D</b> Awning Room with Fly Screen Netting (Suits 2m Awning IAWNING2M)	<b>IAWNING2MROOM</b>	\$303.00
Awning Room with Fly Screen Netting (Suits 2.5m Awning IAWNING2.5M)	<b>IAWNING2.5MROOM</b>	\$335.00
<b>E</b> Instant Ensuite 1m x 1m	<b>IENSUITE</b>	\$308.00
Awning Pole Kit (2 x Poles, Ropes and Pegs to suit Awning Rooms)	<b>IAWNINGPART009</b>	\$36.00

**AWNINGS AND ACCESSORIES DIMENSIONS  
SEE PAGE 458**



# LED Driving Lights

Product Description

Part No.

Retail  
ea Inc GST

**LED DRIVING LIGHTS**

<b>A</b>	120W Megatom 2 in 1 Tri-Mode Operation LED Driving Light (Ea) - <i>While Stocks Last</i>	IMEGATOM	\$510.00
<b>B</b>	99W 5x7 Eclipse LED with Side Shooters - Driving Light (Each)	ILED5X7	\$250.00
<b>C</b>	102W Meteor 9" LED with Daytime Running Light - Driving Light (Each)	ILED9M	\$374.00
<b>D</b>	48W Meteor 7" LED with Daytime Running Light - Driving Light (Each)	ILED7M	\$276.00
<b>E</b>	48W Blast Phase II 7" Combo LED - Driving Light (Each)	ILEDBLAST2C	\$250.00
<b>F</b>	48W Blast Phase II 7" Spot LED - Driving Light (Each)	ILEDBLAST2S	\$250.00
<b>G</b>	30W Comet 7" LED - Driving Light (Each) - <i>While Stocks Last</i>	ILED7C	\$199.00
<b>H</b>	42W Comet 9" LED - Driving Light (Each) - <i>While Stocks Last</i>	ILED9C	\$225.00

**BULL BAR LIGHT UPGRADES**

<b>I</b>	10W Halogen lamp LED replacement to suit Ironman 4x4 Bull Bar Light Pod (Pair)	BBPART031	\$109.00
<b>J</b>	Bull Bar LED Parker / Indicator / Daytime Running Light (Pair)	BBPART002	\$165.00

**TECHNICAL DIMENSIONS AND SPECIFICATIONS  
SEE PAGE 448**

**DRIVING LIGHTS**



**BULL BAR UPGRADE LIGHTS**





# LED Lightbars

Product Description

Part No.

Retail  
ea Inc GST

**LED LIGHTBARS**

<b>A</b>	30W Bright Sabre-X Single Row Slim Lightbar 177mm (7") Straight	<b>ILBSR005B</b>	\$79.00
<b>B</b>	105W Bright Sabre-X Single Row Slim Lightbar 522mm (20") Straight	<b>ILBSR003B</b>	\$210.00
<b>C</b>	165W Bright Sabre-X Single Row Slim Lightbar 798mm (32") Straight	<b>ILBSR002B</b>	\$295.00
<b>D</b>	210W Bright Sabre-X Single Row Slim Lightbar 1005mm (40") Straight	<b>ILBSR001B</b>	\$385.00
<b>E</b>	270W Bright Sabre-X Single Row Slim Lightbar 1281mm (50") Straight	<b>ILBSR000B</b>	\$419.00
<b>F</b>	75W Bright Sabre Single Row Lightbar 524mm (20") Straight	<b>ILBSR003BW</b>	\$189.00
<b>G</b>	120W Bright Sabre Single Row Lightbar 812mm (32") Straight	<b>ILBSR002BW</b>	\$249.00
<b>H</b>	150W Bright Sabre Single Row Lightbar 1004mm (40") Straight	<b>ILBSR001BW</b>	\$339.00
<b>I</b>	200W Bright Sabre Dual Row Lightbar 561mm (21.5") Straight	<b>ILBDR003B</b>	\$349.00
<b>J</b>	300W Bright Sabre Dual Row Lightbar 815mm (32") Straight	<b>ILBDR002B</b>	\$399.00
<b>K</b>	400W Bright Sabre Dual Row Lightbar 1076mm (42.5") Straight	<b>ILBDR001B</b>	\$449.00
<b>L</b>	300W Bright Sabre Multi-Function Dual Row Lightbar 815mm (32") Straight	<b>ILBDR002BM</b>	\$449.00
<b>M</b>	400W Bright Sabre Multi-Function Dual Row Lightbar 1076mm (42.5") Straight	<b>ILBDR001BM</b>	\$599.00

**BRIGHT SABRE-X SINGLE ROW LED SLIM LIGHTBARS**

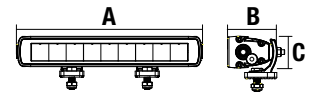

CODE	Beam	LEDs	Watts	A	B	C
ILBSR005B	Combo	6	30W	177mm	54mm	40mm
ILBSR003B	Combo	21	105W	522mm	54mm	40mm
ILBSR002B	Combo	33	165W	798mm	54mm	40mm
ILBSR001B	Combo	42	210W	1005mm	54mm	40mm
ILBSR000B	Combo	54	270W	1281mm	54mm	40mm

**BRIGHT SABRE SINGLE ROW LED LIGHTBARS**

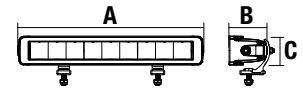

CODE	Beam	LEDs	Watts	A	B	C
ILBSR003BW	Combo	15	75W	524mm	66.5mm	52mm
ILBSR002BW	Combo	24	120W	812mm	66.5mm	52mm
ILBSR001BW	Combo	30	150W	1004mm	66.5mm	52mm

**BRIGHT SABRE DUAL ROW LED LIGHTBARS**

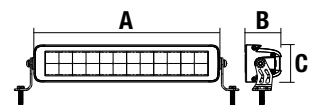

CODE	Beam	LEDs	Watts	A	B	C
ILBDR003B	Combo	40	200W	561mm	67mm	70mm
ILBDR002B	Combo	60	300W	815mm	67mm	70mm
ILBDR001B	Combo	80	400W	1076mm	67mm	70mm

**BRIGHT SABRE DUAL ROW MULTI-FUNCTION LED LIGHTBARS**

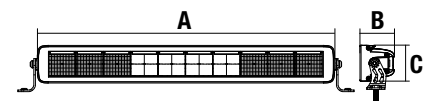

CODE	Beam	LEDs	Watts	A	B	C
ILBDR002BM	Combo	60	300W	815mm	70mm	67mm
<i>Interspersed Multi-Function LEDs - 45 White LEDs / 60 Amber LEDs</i>						
ILBDR001BM	Combo	80	400W	1076mm	70mm	67mm
<i>Interspersed Multi-Function LEDs - 60 White LEDs / 75 Amber LEDs</i>						





# LED Lightbars / Driving Light Accessories

Product Description

Part No.

Retail  
ea Inc GST

## NIGHT SABRE SINGLE ROW LED LIGHTBARS



### STRAIGHT BAR



### CURVED BAR

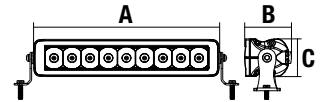

CODE	Beam	LEDs	Watts	A	B	C
<b>Straight Bar</b>						
ILBSR004	Spot	9	45W	279mm	63mm	54mm
ILBSR003	Spot	18	90W	500mm	63mm	54mm
ILBSR002	Spot	27	135W	722mm	63mm	54mm
ILBSR001	Spot	36	180W	942mm	63mm	54mm

<b>Curved Bar</b>						
ILBSR003C	Spot	18	90W	500mm	63mm	54mm
ILBSR002C	Spot	27	135W	722mm	63mm	54mm
ILBSR001C	Spot	36	180W	942mm	63mm	54mm

## MODULAR LIGHTBARS



**TECHNICAL DIMENSIONS AND SPECIFICATIONS  
SEE PAGE 450**

### LED LIGHTBARS

<b>A</b>	180W Night Sabre Lightbar 942mm (37") Straight - <i>While Stocks Last</i>	<b>ILBSR001</b>	\$437.00
<b>B</b>	135W Night Sabre Lightbar 722mm (28.5") Straight - <i>While Stocks Last</i>	<b>ILBSR002</b>	\$335.00
<b>C</b>	90W Night Sabre Lightbar 500mm (19.5") Straight - <i>While Stocks Last</i>	<b>ILBSR003</b>	\$238.00
<b>D</b>	45W Night Sabre Lightbar 279mm (11") Straight - <i>While Stocks Last</i>	<b>ILBSR004</b>	\$180.00
<b>E</b>	180W Night Sabre Lightbar 942mm (37") Curved - <i>While Stocks Last</i>	<b>ILBSR001C</b>	\$476.00
<b>F</b>	135W Night Sabre Lightbar 722mm (28.5") Curved - <i>While Stocks Last</i>	<b>ILBSR002C</b>	\$374.00
<b>G</b>	90W Night Sabre Lightbar 500mm (19.5") Curved - <i>While Stocks Last</i>	<b>ILBSR003C</b>	\$279.00
<b>H</b>	30W Modular Lightbar Flood - 180mm - <i>While Stocks Last</i>	<b>ILED180F</b>	\$199.00
<b>I</b>	30W Modular Lightbar Spot - 180mm - <i>While Stocks Last</i>	<b>ILED180S</b>	\$199.00

### LED DRIVING LIGHT COVERS

<b>J</b>	To Fit 7" Blast - Blue	<b>ILCB7BLUE</b>	\$22.00
<b>K</b>	To Fit 7" Blast - Black	<b>ILCB7BLACK</b>	\$22.00
<b>L</b>	To Fit 7" Blast - Amber	<b>ILCB7AMBER</b>	\$22.00
<b>M</b>	To Fit 7" Blast - Clear	<b>ILCB7CLEAR</b>	\$22.00
<b>J</b>	To Fit 7" Comet - Blue	<b>ILC7BLUE</b>	\$22.00
<b>K</b>	To Fit 7" Comet - Black	<b>ILC7BLACK</b>	\$22.00
<b>L</b>	To Fit 7" Comet - Amber	<b>ILC7AMBER</b>	\$22.00
<b>M</b>	To Fit 7" Comet - Clear	<b>ILC7CLEAR</b>	\$22.00
<b>J</b>	To Fit 9" Comet - Blue	<b>ILC9BLUE</b>	\$28.00
<b>K</b>	To Fit 9" Comet - Black	<b>ILC9BLACK</b>	\$28.00
<b>L</b>	To Fit 9" Comet - Amber	<b>ILC9AMBER</b>	\$28.00
<b>M</b>	To Fit 9" Comet - Clear	<b>ILC9CLEAR</b>	\$28.00

## DRIVING LIGHT COVERS



# LED Work Lights

Product Description	DATE AVAILABLE	Part No.	Retail ea Inc GST
<b>LED WORK / BAR LIGHTS</b>			
<b>A</b> 30W Universal 3" with Side Shooters (Each)		ILEDUNI3	\$80.00
<b>B</b> 61W Universal 5" with Side Shooters (Each)		ILEDUNI5	\$165.00
<b>C</b> 18W Star Brite Rechargeable LED Floodlight (Each)		ILEDSB	\$166.00
<b>D</b> 20W Cosmo Dual LED Light (Each)		ILEDCOSMO	\$165.00
<b>E</b> 10W Spot Beam Universal LED Work Light - 93mm (Each) - Clear		ILEDWL10	\$49.00
<b>F</b> 10W Flood Beam Universal LED Work Light - 93mm (Each) - Amber		ILEDWL10FA	\$49.00
<b>G</b> 9W Flood Beam LED Rock Light - 77 x 44mm (Each) - Clear		IRL120B	\$30.00
<b>H</b> 20W Bright Cube Spot Beam LED Cube Light - 70 x 64mm (Each) - Clear		ILED20B	\$59.00
20W Bright Cube Spot Beam LED Cube Light - 70 x 64mm (Each) - Amber		ILED20BA	\$59.00
<b>I</b> 20W Bright Cube Flood Beam LED Cube Light - 70 x 64mm (Each) - Clear		ILED20BF	\$59.00
<b>J</b> 20W Bright Cube Flood Beam LED Cube Light - 70 x 64mm (Each) - Amber		ILED20BFA	\$59.00
20W Bright Cube Flood Beam LED Cube Light - 70 x 64mm (Each) - Red		ILED20BFR	\$59.00
<b>K</b> 40W Bright Cube Spot Beam LED Cube Light - 81 x 75mm (Each) - Clear		ILED80B	\$79.00
40W Bright Cube Spot Beam LED Cube Light - 81 x 75mm (Each) - Amber		ILED80BA	\$79.00
<b>L</b> 40W Bright Cube Flood Beam LED Cube Light - 81 x 75mm (Each) - Clear		ILED80BF	\$79.00
<b>M</b> 40W Bright Cube Flood Beam LED Cube Light - 81 x 75mm (Each) - Amber		ILED80BFA	\$79.00

**TECHNICAL DIMENSIONS AND SPECIFICATIONS  
SEE PAGE 449**

## LED WORK LIGHTS



# Wire Looms / Auto Electrical / Dual Battery Systems

Product Description

Part No.

Retail  
ea Inc GST

**LIGHT WIRING LOOMS - SEE PAGE 451 FOR WIRING DIAGRAMS**

Light Bar / Work Light Wiring Loom - Suits One (1) Light	IWHL001	\$39.00
Driving Light Wiring Loom - Suits Set of Two (2) Lights	IWHL002	\$57.00
Driving Light Wiring Loom - Suits Set of Two (2) Lights with Daytime Running Lights	IWHL003	\$63.00
Megatom Wiring Loom - Suits Set of Two (2) Megatom Lights	IWHL004	\$100.00

**DRIVING LIGHT PATCH LOOMS**

Patch Loom to suit Ford Ranger and Everest	IPL066	\$36.00
Patch Loom to suit Holden Colorado RG	IPL057	\$31.00
Patch Loom to suit Isuzu D-Max and MU-X	IPL058	\$31.00
Patch Loom to suit Jeep Wrangler JL and Gladiator JT	IPL077	\$36.00
Patch Loom to suit Mitsubishi Triton MR	IPL067	\$31.00
Patch Loom to suit Mitsubishi Triton MQ	IPL050	\$31.00
Patch Loom to suit Nissan Navara NP300	IPL048	\$31.00
Patch Loom to suit Suzuki Jimny GJ 2018+	IPL070	\$31.00
Patch Loom to suit Toyota Landcruiser 200 Series 2006+	IPL056	\$31.00
Patch Loom to suit Volkswagen Amarok	IPL060	\$31.00

**AUTO ELECTRICAL**

<b>A</b> 40A DC to DC Battery Charger with Solar Input (Not comp. with IDCDCSA Start Assist)	IDCDCSOLAR	\$633.00
<b>B</b> 40A DC to DC Battery Charger (80A when combined with Start Assist Kit)	IDCDC40	\$565.00
<b>C</b> Start Assist Booster Kit (Suits IDCDC40 Only)	IDCDCSA	\$158.00
<b>D</b> 12V Digital Battery Monitor (Suits single and dual battery setups)	IDBM001	\$173.00
<b>E</b> 140A Battery Manager (Only)	DB140	\$115.00
<b>F</b> 275A Battery Manager (Only)	DB270	\$286.00
Dual Battery Loom - <i>While Stocks Last</i>	DB LOOM	\$220.00
<b>G</b> Universal Fit Battery Tray for Ute Tubs	IBTRAYTUB	\$239.00
<b>H</b> Electric Brake Controller (With Remote Head)	IEBC001	\$226.00
<b>I</b> 50A Charge Wire Kit (6m x 8mm <sup>2</sup> High Current Cable)	IAPKIT	\$140.00

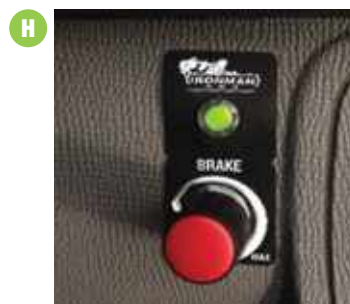



# Storage - Locksafe Drawer Systems

Product Description	DATE AVAILABLE	Part No.	Retail ea Inc GST
<b>A LOCKSAFE SINGLE DRAWERS</b>			
Single Drawer - 900mm		ISD900	\$767.00
Single Drawer - 1000mm		ISD1000	\$784.00
Single Drawer - 1300mm		ISD1300	\$891.00
<b>B LOCKSAFE TWIN DRAWERS</b>			
Twin Drawers - 900mm		ITD900	\$1242.00
Twin Drawers - 1000mm		ITD1000	\$1296.00
Twin Drawers - 1300mm		ITD1300	\$1469.00
<b>WING KITS*</b>			
Left and Right Pair - 900mm		Vehicle Specific	\$270.00
Left and Right Pair - 1000mm		Vehicle Specific	\$270.00
Left and Right Pair - 1300mm		Vehicle Specific	\$351.00
<b>FRIDGE / FREEZER SLIDES</b>			
Fridge Slide - 30L, 40L, 50L (Inc. 4 x straps)		IFRIDGESLIDE001	\$270.00
Fridge Slide - 65L, 74L (Inc. 4 x straps)		IFRIDGESLIDE002	\$373.00
Fridge Slide - 30 to 50L - Tilt (Inc. 4 x straps)	Q1 2022	IFRIDGESLIDE034	\$359.00
Fridge Slide - 65 to 70L - Tilt (Inc. 4 x straps)	Q1 2022	IFRIDGESLIDE045	\$459.00

**TECHNICAL DIMENSIONS AND SPECIFICATIONS SEE PAGE 454  
REFER TO VEHICLE LISTING PAGES FOR SPECIFIC MODEL COMPATIBILITY / SUITABILITY**



A



B



**\*Designed to suit factory tubs, will not suit tub liner without modification**

# Storage - Water Tanks

Product Description

Part No.

Retail  
ea Inc GST

**WATER TANKS - L X D X H**

<b>A</b> 20L Jerry Can with Tap - (350 x 170 x 460mm)	<b>IWT001</b>	\$103.00
<b>B</b> 40L Double Jerry Can with Barbed Outlet - (465 x 340 x 335mm)	<b>IWT002</b>	\$197.00
<b>C</b> 40L Vertical Tank with Barbed Outlet - (1100 x 75 x 700mm*)	<b>IWT003</b>	\$327.00
<b>D</b> 50L Roof Rack Tank with Barbed Outlet - (1200 x 600 x 120mm*)	<b>IWT004</b>	\$327.00
<b>E</b> 50L Wheel Arch Tank with Barbed Outlet - (1215 x 120 x 590mm*)	<b>IWT005</b>	\$327.00
<b>F</b> 50L Tapered Tank with Tap and Barbed Outlet - (1050 x 200 x 390mm*)	<b>IWT006</b>	\$258.00
<b>G</b> 60L Tank with Tap and Barbed Outlet - (845 x 360 x 270mm*)	<b>IWT007</b>	\$262.00
<b>H</b> 1.5m Plastic Water Hose Kit - Connects to barbed outlet on tanks	<b>IWTHOSE</b>	\$54.00
<b>I</b> 15L Under Tray Hand Wash Tank with Tap - (345 x 255 x 305mm)	<b>IWT008</b>	\$176.00

\*Includes the height of the screw cap

**WATER PUMP**

<b>J</b> Pressure Water Pump - 12.5L / 12VDC	<b>IWP0023</b>	\$145.00
--	----------------	----------



# Storage - Plastic

Product Description

Part No.

Retail  
ea Inc GST

**MAXI CASES - L X D X H**

<b>A</b>	48L - 410 x 410 x 410mm - *Does not include removable tool tray	<b>IMC001</b>	\$174.00
<b>B</b>	60L - 550 x 460 x 335mm (Includes tool tray)	<b>IMC002</b>	\$218.00
<b>C</b>	65L - 900 x 460 x 250mm - *Does not include removable tool tray	<b>IMC006</b>	\$269.00
<b>D</b>	100L - 700 x 460 x 410mm (Includes tool tray)	<b>IMC003</b>	\$273.00
<b>E</b>	140L - 915 x 460 x 440mm (Includes tool tray)	<b>IMC004</b>	\$347.00
<b>F</b>	216L - 1300 x 460 x 460mm (Includes tool tray)	<b>IMC005</b>	\$445.00

**UTE BOXES - L X D X H**

<b>G</b>	200L - 1400 x 540 x 540mm - <i>While Stocks Last</i>	<b>UTEBOX002</b>	\$685.00
<b>H</b>	140L - 1320 x 505 x 475mm - <i>While Stocks Last</i>	<b>UTEBOX001</b>	\$655.00





# Storage - Metal

Product Description

Part No.

Retail  
ea Inc GST

**ALUMINIUM TOOL BOXES - L X D X H**

<b>A</b> Aluminium One Tonner - 900 x 500 x 680mm - <i>While Stocks Last</i>	<b>ITB001</b>	\$659.00
<b>B</b> Aluminium One Tonner - 1210 x 500 x 680mm - <i>While Stocks Last</i>	<b>ITB002</b>	\$786.00
<b>C</b> Aluminium Low Profile - 950 x 600 x 500mm - <i>While Stocks Last</i>	<b>ITB003</b>	\$520.00
<b>D</b> Aluminium Low Profile - 1250 x 600 x 500mm - <i>While Stocks Last</i>	<b>ITB004</b>	\$659.00
<b>E</b> Aluminium Gull Wing Truck Box - 1770 x 550 x 400mm - <i>While Stocks Last</i>	<b>ITB009</b>	\$713.00
<b>F</b> Aluminium Under-Tray Box - 750/520 x 270 x 440mm (LHS) - <i>While Stocks Last</i>	<b>ITB007</b>	\$270.00

**STEEL TOOL BOXES - L X D X H**

<b>G</b> Steel Truck Box - 700 x 640 x 750mm	<b>ITB005</b>	\$1038.00
<b>H</b> Steel Truck Box - 1210 x 640 x 750mm	<b>ITB006</b>	\$1485.00



# Storage - Bags

Product Description

Part No.

Retail  
ea Inc GST

**CARRY AND UTILITY STORAGE BAGS - L X W X D**

<b>A</b>	200L Weatherproof Rooftop Cargo Storage Bag - 1400 x 500 x 300mm	<b>IRLB200</b>	\$193.00
<b>B</b>	250L Weatherproof Rooftop Cargo Storage Bag - 1100 x 800 x 300mm	<b>IRLB250</b>	\$216.00
<b>C</b>	350L Weatherproof Rooftop Cargo Storage Bag - 1200 x 960 x 300mm	<b>IRLB350</b>	\$250.00
<b>D</b>	500L Weatherproof Rooftop Cargo Storage Bag - 1500 x 1100 x 300mm	<b>IRLB500</b>	\$296.00
<b>E</b>	600L Weatherproof Rooftop Cargo Storage Bag - 1800 x 1100 x 300mm	<b>IRLB600</b>	\$335.00
<b>F</b>	50L Cargo Bag	<b>ICARGOBAG001</b>	\$39.00
<b>G</b>	65L Explorer Duffle Bag	<b>IDUFBAG001</b>	\$83.00
<b>H</b>	Rooftop Tent Hanging Bag	<b>ITENTBAG001</b>	\$40.00





# Alloy Roof Racks / Extrusion Rails

Product Description

Part No.

Retail  
ea Inc GST

**ALLOY ROOF RACKS - POWDERCOATED METALLIC GREY, MESH FLOOR**

<b>A</b> Flat Rack - 1.8m x 1.25m	IRRTFLAT18-ALLOY	\$1116.00
<b>B</b> Cage Style - 1.4m x 1.25m	IRRCAGE14-ALLOY	\$983.00
<b>B</b> Cage Style - 1.8m x 1.25m	IRRCAGE18-ALLOY	\$1149.00
<b>B</b> Cage Style - 2.2m x 1.25m	IRRCAGE22-ALLOY	\$1212.00
<b>C</b> Trade Style - 1.4m x 1.25m (Open end)	IRROPEN14-ALLOY	\$971.00
<b>C</b> Trade Style - 1.8m x 1.25m (Open end)	IRRTRADE18-ALLOY	\$1132.00
<b>C</b> Trade Style - 2.2m x 1.25m (Open end)	IRRTRADE22-ALLOY	\$1181.00
Crossbar	IRRCROSSBAR001	\$274.00

**UNIVERSAL ALLOY ROOF RAIL EXTRUSION - SOLD SEPARATELY**

<b>D</b> Alloy Extrusion - 1085mm (2 Pieces - Inc. mounting hardware)	IRREXT1085	\$124.00
---	------------	----------

**REFER TO VEHICLE LISTING PAGES FOR SPECIFIC MODEL COMPATIBILITY / SUITABILITY**



**NEW**



GUTTER MOUNT FEET



CHANNEL MOUNT FEET

# Steel Roof Racks / Mount Kits

Product Description

Part No.

Retail  
ea Inc GST

**STEEL ROOF RACKS - POWDERCOATED BLACK, MESH FLOOR**

<b>A</b> Cage Style - 1.4m x 1.25m	IRRCAE14	\$777.00
<b>B</b> Cage Style - 1.8m x 1.25m	IRRCAE18	\$815.00
<b>C</b> Cage Style - 2.2m x 1.25m	IRRCAE22	\$846.00
<b>D</b> Rooftop Tent Compatible - 1.8m x 1.25m	IRRTENT18	\$777.00
<b>E</b> Rooftop Tent Compatible - 2.2m x 1.25m	IRRTENT22	\$815.00
<b>F</b> Trade Style - 1.8m x 1.25m (Open end)	IRRTRADE18	\$777.00
<b>G</b> Trade Style - 2.2m x 1.25m (Open end)	IRRTRADE22	\$809.00

**REFER TO VEHICLE LISTING PAGES FOR SPECIFIC MODEL COMPATIBILITY / SUITABILITY**



**ROOF RACK MOUNTING KITS - SOLD SEPARATELY**

Gutter Mount Feet - 100mm (8 Feet)	IRRFEE100	\$198.00
Gutter Mount Feet - 125mm (8 Feet)	IRRFEE125	\$198.00
Gutter Mount Feet - 150mm (8 Feet)	IRRFEE150	\$198.00
Gutter Mount Feet - 210mm (8 Feet)	IRRFEE210	\$218.00
Mount Feet to suit Holden Colorado 7/Trailblazer (6 Feet) - Fits fact fitted roof bars only	IRRFEE001	\$198.00
Mount Feet to suit Toyota Landcruiser 100/105 (8 Feet)	IRRFEE1C100	\$198.00
Mount Feet to suit Toyota Landcruiser 200 (8 Feet)	IRRFEE1C200	\$198.00
Mount Feet to suit Isuzu MU-X (6 Feet) - Fits factory fitted roof bars only	IRRFEE1MUX	\$218.00
Mount Feet to suit Toyota Prado 150 (2 Feet)	IRRFEE1PRADO150	\$218.00
ABS Canopy Feet to suit 1.4m Rack	IRRFEE1ABS14	\$274.00
Wheel Clamp	IRRWHEEL CLAMP	\$100.00

**TECHNICAL DIMENSIONS AND SPECIFICATIONS SEE PAGE 446  
REFER TO VEHICLE MANUFACTURER FOR SPECIFIC ROOF LOAD CARRYING CAPACITY**



# Fleet and Mining Accessories

Product Description

Part No.

Retail  
ea Inc GST

**FLEET / MINING ACCESSORIES**

<b>A</b> High Visibility Light Bar (With lights, reverse alarm and beacon)	<b>MINING005</b>	\$449.00
<b>B</b> Fire Extinguisher (1kg)	<b>IFIRE EXTINGUISHER</b>	\$47.00
<b>C</b> High Mount Flag - 1.8m (With red LED)	<b>MINING001</b>	\$147.00
<b>D</b> High Mount Flag - 2.4m (With red LED)	<b>MINING008</b>	\$152.00
<b>E</b> Hi Vis Sand Flag (1m, 2m or 3m length)	<b>IHVFLAG</b>	\$150.00
<b>F</b> Reverse Camera - OE Appr. (With rear view mirror replacement) - <i>While Stocks Last</i>	<b>IREVERSECAM001</b>	\$594.00
<b>G</b> Safety Triangles (set of 3)	<b>ISAFETYTRI</b>	\$95.00
<b>H</b> Universal Battery Isolator / Jump Start	<b>IBATISO</b>	\$327.00
<b>I</b> Wheel Chocks - Rated to 6 tonne (set of 2)	<b>IWC6T</b>	\$118.00

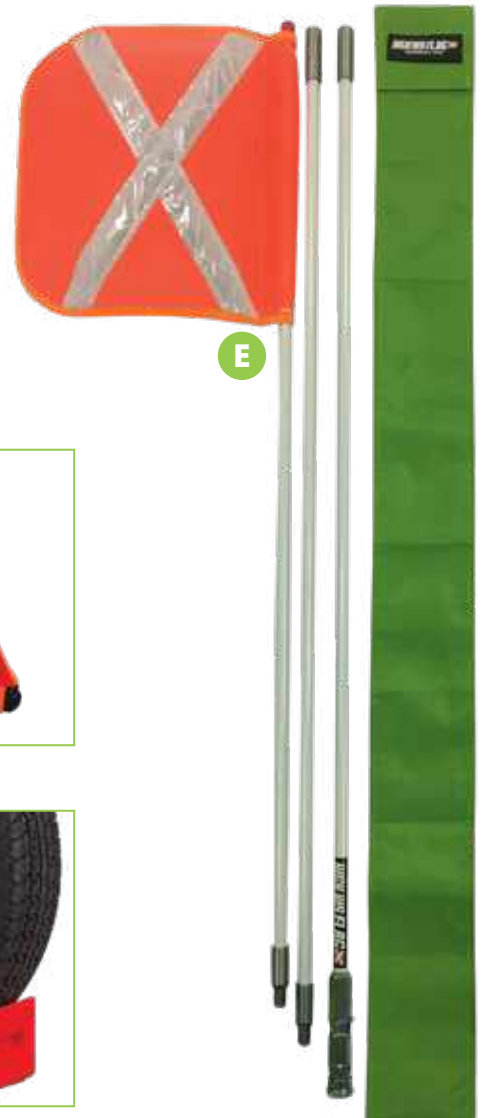

# Apparel

Product Description

Part No.

Retail  
ea Inc GST

**IRONMAN 4X4 BASEBALL CAPS**

- A** Ironman 4x4 Breezy Cap - Curved Peak Black Cap
- B** Ironman 4x4 Bank Cap - Flat Peak Grey Cap

<b>CAP002</b>	\$32.00
<b>CAP003</b>	\$32.00

**IRONMAN 4X4 60TH ANNIVERSARY T-SHIRT**

- C** Size Mens - S
- Size Mens - M
- Size Mens - L
- Size Mens - XL
- Size Mens - 2XL
- Size Mens - 3XL
- Size Mens - 5XL
- Size Womens - S
- Size Womens - M
- Size Womens - L
- Size Womens - XL

<b>IMTS001MS</b>	\$33.00
<b>IMTS001MM</b>	\$33.00
<b>IMTS001ML</b>	\$33.00
<b>IMTS001MXL</b>	\$33.00
<b>IMTS001M2XL</b>	\$33.00
<b>IMTS001M3XL</b>	\$33.00
<b>IMTS001M5XL</b>	\$33.00
<b>IMTS001WS</b>	\$33.00
<b>IMTS001WM</b>	\$33.00
<b>IMTS001WL</b>	\$33.00
<b>IMTS001WXL</b>	\$33.00

**IRONMAN 4X4 FOAM CELL PRO T-SHIRT**

- D** Size Mens - S
- Size Mens - M
- Size Mens - L
- Size Mens - XL
- Size Mens - 2XL
- Size Mens - 3XL
- Size Mens - 5XL

<b>IMTS002MS</b>	\$38.00
<b>IMTS002MM</b>	\$38.00
<b>IMTS002ML</b>	\$38.00
<b>IMTS002MXL</b>	\$38.00
<b>IMTS002M2XL</b>	\$38.00
<b>IMTS002M3XL</b>	\$38.00
<b>IMTS002M5XL</b>	\$38.00

**OILSKIN CAPRICORN VEST**

- E** Size - XL - *While Stocks Last*
- Size - XXXL - *While Stocks Last*
- Size - XXXXL - *While Stocks Last*

<b>IMCAPRIBN07</b>	\$192.00
<b>IMCAPRIBN09</b>	\$192.00
<b>IMCAPRIBN10</b>	\$192.00

**OILSKIN COOPER JACKET**

- F** Size - M - *While Stocks Last*
- Size - XXL - *While Stocks Last*
- Size - XXXL - *While Stocks Last*
- Size - XXXXL - *While Stocks Last*

<b>IMCOOPBN05</b>	\$316.00
<b>IMCOOPBN08</b>	\$316.00
<b>IMCOOPBN09</b>	\$316.00
<b>IMCOOPBN10</b>	\$316.00





# Merchandise

Product Description

Part No.

Retail  
ea Inc GST

**MERCHANDISE**

A	Ironman 4x4 Key Rings	KEY001	\$3.00
B	Ironman 4x4 Bottle Opener Key Rings	KEY002	\$4.00
C	Ironman 4x4 Numberplate Surrounds - Standard Fit (Pair)	INUMBPLATE	\$9.00
D	Ironman 4x4 Numberplate Surrounds - Slimline Fit (Pair)	INUMBPLATESLIM	\$9.00
E	Black Ironman 4x4 Cap	CAPO01	\$14.00
F	Ironman 4x4 Car Air Freshener (Adventure Fresh) *Non-retail sold as box of 150 only	IAIRFRESHBOX	\$1.10
G	Ironman 4x4 Stubby Holder	CAN001	\$6.00
H	Ironman 4x4 Metal Drink Bottle - Silver with Ironman 4x4 Logo	IBOTTLE001	\$16.00
I	Ironman 4x4 Metal Drink Bottle - Grey with Foam Cell Pro Logo	IBOTTLE002	\$16.00
J	Discover Oz Productions - Top Of Down Under DVD (Vol 2)	DVD001	\$40.00
J	Discover Oz Productions - Top Of Down Under DVD (Vol 3)	DVD004	\$40.00
J	Discover Oz Productions - Top Of Down Under DVD (Vol 4)	DVD006	\$40.00
J	Discover Oz Productions - Top Of Down Under DVD (Vol 5)	DVD007	\$40.00
J	Discover Oz Productions - Top Of Down Under DVD (Vol 6)	DVD008	\$40.00
K	Ironman 4x4 Adventure Challenge WA 2012 - <i>While Stocks Last</i>	DVD002	\$33.00
K	Ironman 4x4 Adventure Challenge WA 2013 - <i>While Stocks Last</i>	DVD003	\$33.00
K	Ironman 4x4 Adventure Challenge WA 2014 - <i>While Stocks Last</i>	DVD005	\$38.00
K	Ironman 4x4 Adventure Challenge WA 2016 - <i>While Stocks Last</i>	DVD009	\$33.00
L	The Australian 4WD Handbook	IBOOK001	\$49.00







Unlock your adventure



• ACCESSORIES • SUSPENSION • GVM UPGRADES

for a full range of accessories visit our website

[www.ironman4x4.com](http://www.ironman4x4.com)





# ***Accessories and Suspension***

**CATALOGUE AND PRICE LIST**

**Effective 1 November 2021**





# Dacia Duster

2010+



Product Description

Part No.

Qty  
Req

Retail  
ea Inc GST

## SUSPENSION TO SUIT DACIA DUSTER

### FRONT SUSPENSION

**SHOCK ABSORBER**

Nitro Gas Strut - Performance

**12747GR** 2 \$278.00

**COIL SPRINGS**

Medium Est. Lift 40mm Additional Load 0 - 50kg

**REN001B** 1 \$250.00

**CAMBER CORRECTION**

Camber Bolt Kit

**ICAMBER12** 1 \$28.00

### REAR SUSPENSION

**SHOCK ABSORBER**

Nitro Gas Strut - Performance

**12748GR** 2 \$278.00

**COIL SPRINGS**

Medium Est. Lift 40mm Additional Load 0 - 200kg

**REN002B** 1 \$250.00

**CAMBER CORRECTION**

Camber Bolt Kit

**ICAMBER12** 1 \$28.00

### SUSPENSION KIT

Medium - Nitro Gas

**REN001BKG** \$1663.00

### SUSPENSION KIT CONTENTS

Shock Absorbers

Camber Bolt Kits

Coil Springs



## Fiat Fullback



2016+

Product Description

Part No.

Qty  
ReqRetail  
ea Inc GST

## ACCESSORIES TO SUIT FIAT FULLBACK

**STEEL WINCH BULL BARS**

Commercial	BBC050	\$1678.00
Commercial Deluxe	BBCD050	\$2284.00
Polished Alloy	BBA050	\$2845.00
Proguard No Loop	BBT050-NL	\$1888.00
Proguard Single Loop Kit	BB050-SL	\$336.00
Proguard Triple Loop Kit	BB050-TL	\$404.00

**STEEL SIDE STEPS AND RAILS - FITS DUAL AND CLUB CAB**

Side Steps	SS050	\$962.00
Side Rails	SS050 RAIL	\$317.00
Side Steps and Rails	SSR050	\$1155.00

**TOWING**

Class 4 Towbar - Compatible with Factory Rear Bumper	TB050	\$581.00
Rear Protection Towbar - Full Rear Bumper Replacement	RTB050	\$1328.00
Rear Protection Towbar Plates (Pair)	RTBPLATE050	\$146.00
Towbar Wiring Loom - Plug and Play	ITBL050	\$264.00

**RECOVERY POINTS - IRONMAN 4X4 BULL BAR ONLY**

Recovery Points - 5000kg Rating (Pair)	IRP050	\$287.00
--	--------	----------

**BATTERY TRAY**

Suits 12" Battery	IBTRAY050	\$229.00
-------------------	-----------	----------

**SNORKEL - SUITS 2.4L DIESEL**

Triton MQ 2015+	ISNORKEL050	\$418.00
-----------------	-------------	----------

**LONG RANGE FUEL TANK**

125L* Diesel only - Fits Dual Cab only	TANK004	\$1129.00
--	---------	-----------

\* Usable volume may differ to the stated tank capacity

**PREMIUM UNDERBODY PROTECTION**

Engine Bay and Transmission	UBP050	\$748.00
-----------------------------	--------	----------

**UNDERBODY PROTECTION**

Engine Bay and Transmission - Not compatible with bull bars. - <i>While Stocks Last</i>	IUP050K	\$563.00
---	---------	----------

**EXHAUST SYSTEM**

3" Exhaust Upgrade 2.4L 2015+ - DPF Back - <i>While Stocks Last</i>	IEX067	\$770.00
---	--------	----------

**LOCKSAFE DRAWER SYSTEMS - FITS DUAL AND EXTRA CAB**

Twin Drawers - 1300mm	ITD1300	\$1469.00
Single Drawer - 1300mm	ISD1300	\$891.00
Wing Kit - 1300mm*	ITDW050	\$351.00

\* Designed to suit factory tubs, will not suit ute liner without modification.

**CANOPY - ABS PLASTIC (SIDE LIFT UP WINDOWS AND CENTRAL LOCKING REAR DOOR) - FITS 4X4 AND 4X2 DUAL CAB MODELS**

Pre Primed	CANOPY014-P	\$3238.00*
Black Mica (X08)	CANOPY014-BM	\$3856.00
Impulse Blue (D23)	CANOPY014-IB	\$3856.00
White Solid (W32)	CANOPY014-WS	\$3856.00

\* See Page 37 and 38 for 1.4m Roof Rack options and pricing.

\* Pre-primed canopies, plus colour coding.

**CANOPY - PINNACLE SMOOTH FINISH FIBREGLASS (SIDE LIFT UP WINDOWS AND CENTRAL LOCKING REAR DOOR) - FITS 4X4 AND 4X2 DUAL CAB MODELS**

Pre-Primed	CANFIBRE050-P	\$2899.00*
Black Mica (X08)	CANFIBRE050-BM	\$3399.00
Impulse Blue (D23)	CANFIBRE050-IB	\$3399.00
Titanium Grey (U17)	CANFIBRE050-TG	\$3399.00
Sterling Silver (U25)	CANFIBRE050-SS	\$3399.00
White Solid (W32)	CANFIBRE050-WS	\$3399.00

\* Pre-primed canopies, plus colour coding.

**CANOPY - PINNACLE 2 FIBREGLASS (SIDE LIFT UP WINDOWS AND CENTRAL LOCKING REAR DOOR) - FITS 4X4 AND 4X2 DUAL CAB MODELS**

Pre-Primed	ICANOPY050-P	\$2899.00*
Black Mica (X08)	ICANOPY050-BM	\$3399.00
Graphite Grey (U28)	ICANOPY050-GG	\$3399.00
Impulse Blue (D23)	ICANOPY050-IB	\$3399.00
Sterling Silver (U25)	ICANOPY050-SS	\$3399.00
Titanium Grey (U17)	ICANOPY050-TG	\$3399.00
White Solid (W32)	ICANOPY050-WS	\$3399.00

**DIFF BREATHER KIT**

Diff Breather Kit	IDIFFBRE	\$114.00
-------------------	----------	----------





## SUSPENSION TO SUIT FIAT FULLBACK

### FRONT SUSPENSION

#### SHOCK ABSORBER

Nitro Gas Strut - Performance <sup>1</sup>			<b>12715GR</b>	2	\$222.00
Foam Cell Strut - Performance <sup>1</sup>			<b>24715FE</b>	2	\$250.00
Foam Cell Pro Strut - Performance* (SEE NOTE)			<b>45715FE</b>	2	\$388.00

\*NOTE: MANDATORY FITMENT of UCA050FA and MITS045B /C Coil Springs with 45715FE

<sup>1</sup> Height adjustable with Ironman 4x4 Strut Trim Packers

#### COIL SPRINGS

	Est. Lift	Additional Load			
Standard	0mm	0 - 50kg	<b>MITSO40S</b>	1	\$250.00
Light	25mm	0 - 50kg	<b>MITSO40A</b>	1	\$250.00
Medium	30mm	0 - 80kg	<b>MITSO40B</b>	1	\$250.00
Medium* (SEE NOTE)	50mm	0 - 80kg	<b>MITSO45B *</b>	1	\$250.00
Heavy	30mm	80 - 110kg	<b>MITSO40C</b>	1	\$250.00
Heavy* (SEE NOTE)	50mm	80 - 110kg	<b>MITSO45C *</b>	1	\$250.00

\*NOTE: MANDATORY FITMENT of UCA050FA and 45715FE with (MITSO45B /C) Coil Springs

#### STRUT MOUNTS

Steel Strut Top			<b>ISST010</b>	2	\$97.00
-----------------	--	--	----------------	---	---------

#### TRIM PACKERS

5mm Strut Trim Packer	Nitro Gas / Foam Cell	<b>HILFR05 / HILFR05F</b>	2	\$28.00
10mm Strut Trim Packer	Nitro Gas / Foam Cell	<b>HILFR10 / HILFR10F</b>	2	\$28.00
15mm Strut Trim Packer	Nitro Gas / Foam Cell	<b>HILFR15 / HILFR15F</b>	2	\$28.00

• ONLY Compatible with Ironman 4x4 Struts, lift height subject to 2:1 motion ratio. Unnecessary fitment may lift vehicle too high

#### CONTROL ARMS

Pro-Forge Upper Control Arms			<b>UCA050FA</b>	1	\$882.00
------------------------------	--	--	-----------------	---	----------





## Fiat Fullback

2016+

## Product Description

## Part No.

Qty  
ReqRetail  
ea Inc GST

## REAR SUSPENSION

## SHOCK ABSORBER

Nitro Gas - Comfort			<b>12729GRC</b>	2	\$153.00
Nitro Gas - Performance			<b>12729GR</b>	2	\$153.00
Nitro Gas - Professional			<b>12729GRP</b>	2	\$153.00
Foam Cell - Comfort			<b>24729FEC</b>	2	\$222.00
Foam Cell - Performance			<b>24729FE</b>	2	\$222.00
Foam Cell - Professional			<b>24729FEP</b>	2	\$222.00
Foam Cell Pro - Comfort			<b>45729FEC</b>	2	\$305.00
Foam Cell Pro - Performance			<b>45729FE</b>	2	\$305.00
Foam Cell Pro - Professional			<b>45729FEP</b>	2	\$305.00

## LEAF SPRINGS

	Est. Lift	Additional Load			
Light	30mm	0 - 200kg	<b>MITSO47A</b>	2	\$375.00
Medium	30mm	0 - 300kg	<b>MITSO47B</b>	2	\$375.00
Heavy	30mm	300kg - GVM	<b>MITSO47C</b>	2	\$402.00

• Two piece tailshaft models may experience driveline vibration, use 1201K to reduce vibration.

## U-BOLTS

U-Bolt Kit			<b>437UBK</b>	2	\$42.00
U-Bolt Kit	Suits MITS047C		<b>437UBKL</b>	2	\$42.00

## POLYURETHANE SPRING BUSHES

Bush Kit			<b>1200UK</b>	1	\$84.00
----------	--	--	---------------	---	---------

## DRIVELINE SPACERS

Centre Bearing Spacer Kit			<b>1201K</b>	1	\$111.00
---------------------------	--	--	--------------	---	----------

## SPACER KIT

Brake Hose Relocation Kit			<b>1205K</b>	1	\$56.00
---------------------------	--	--	--------------	---	---------

## GREASABLE SHACKLES AND PINS

Greasable Shackle			<b>1199</b>	2	\$56.00
Non-Greasable Pin			<b>387-1</b>	2	\$28.00

## HELPER SPRINGS

Load Plus Helper Springs			<b>LP3</b>	1	\$157.00
Add-A-Leaf			<b>ISL6010</b>	1	\$167.00

## SUSPENSION KIT

Light - Nitro Gas		<b>MITSO47AKG</b>	\$2078.00
Light - Foam Cell		<b>MITSO47AKF</b>	\$2272.00
Medium - Nitro Gas		<b>MITSO47BKG</b>	\$2078.00
Medium - Foam Cell		<b>MITSO47BKF</b>	\$2272.00
Medium - Foam Cell Pro		<b>MITSO47BKP</b>	\$3597.00
Heavy - Nitro Gas		<b>MITSO47CKG</b>	\$2134.00
Heavy - Foam Cell		<b>MITSO47CKF</b>	\$2328.00
Heavy - Foam Cell Pro		<b>MITSO47CKP</b>	\$3652.20

• Specify Front Coil Springs when ordering

• Two piece tailshaft models may experience driveline vibration, use 1201K to reduce vibration

## SUSPENSION KIT CONTENTS

Shock Absorbers	Coil Springs	Upper Control Arms (Foam Cell Pro Kits Only)	Brake Hose Relocation Kit
Leaf Springs	U-Bolts	Polyurethane Spring Bushes	Centre Bearing Spacer Kit
Strut Shock Absorbers			



Complete vehicle solutions!

for a full range of accessories visit our website

[www.ironman4x4.com](http://www.ironman4x4.com)





2015 to 2020

Product Description

Part No.

Qty  
Req

Retail  
ea Inc GST

**ACCESSORIES TO SUIT FORD F150**

**SLIDE-AWAY ROLL UP HARD TONNEAU COVER**

Electric with Remote Control (Long Bed)

Electric with Remote Control (Short Bed)

**ISLIDEAWAY075-E**

\$2599.00

**ISLIDEAWAY075RB-E**

\$2599.00





# Ford Ranger Raptor

9/2018+



Product Description

Part No.

Qty  
Req

Retail  
ea Inc GST

## ACCESSORIES TO SUIT FORD RANGER RAPTOR

### TOWING

Rear Protection Towbar - Full Rear Bumper Replacement (60.3mm bar)	RTB069	\$1430.00
--	--------	-----------

### BATTERY TRAY - DUAL CAB ONLY

Suits 10" Battery	IBTRAY054	\$192.00
-------------------	-----------	----------

### EXHAUST SYSTEM

3" Exhaust Upgrade 2.0L - DPF Back - <i>While Stocks Last</i>	IEX069	\$770.00
---	--------	----------

### LOCKSAFE DRAWER SYSTEMS - FITS DUAL AND EXTRA CAB

Twin Drawers - 1300mm	ITD1300	\$1469.00
Single Drawer - 1300mm	ISD1300	\$891.00
Wing Kit - 1300mm*	ITDW037	\$351.00

\*Designed to suit factory tubs, will not suit ute liner without modification.

### CANOPY - ABS PLASTIC (SIDE LIFT UP WINDOWS AND CENTRAL LOCKING REAR DOOR) - FITS 4X4 AND 4X2 DUAL CAB MODELS

Pre-Primed	CANOPY010-P †	\$3238.00*
Cool White (WVA) (A2W)	CANOPY010-CW	\$3856.00
Aurora Blue (WVD) (39A)	CANOPY010-AB	\$3856.00
Highlight Silver (18G)	CANOPY010-S	\$3856.00
Winning Blue (WVW)	CANOPY010-WB	\$3856.00
Magnetic Grey (WVQ)	CANOPY010-M †	\$3856.00
True Red (SWH)	CANOPY010-TR	\$3856.00
Meteor Grey (42A) (SWT)	CANOPY010-G †	\$3856.00
Frozen White (WVZ)	CANOPY010-FW †	\$3856.00
Metropolitan Grey (WVT) (36C)	CANOPY010-MG	\$3856.00
Aluminium Metallic (SWR) (38P)	CANOPY010-AM	\$3856.00
Ingot Silver (WVR)	CANOPY010-IS †	\$3856.00
Shadow Black (UO)	CANOPY010-SB †	\$3856.00
Blue Lightning (SW3)	CANOPY010-BL †	\$3856.00
Arctic White (SWU)	CANOPY010-AW †	\$3856.00
ABS Canopy Rack Feet	IRRFETABS14	\$274.00

• Includes tub strengthening bracket (CANOPY010 BRACKET)

• Colour code and build date must be confirmed for Aluminium Metallic Canopies (CANOPY010-AM)

• See Page 37 and 38 for 1.4m Roof Rack options and pricing.

\* Pre-primed canopies, plus colour coding. † Includes central locking.

### CANOPY - PINNACLE SMOOTH FINISH FIBREGLASS (SIDE LIFT UP WINDOWS AND CENTRAL LOCKING REAR DOOR) - FITS 4X4 AND 4X2 DUAL CAB MODELS

Pre-Primed	CANFIBRE054-P	\$2899.00*
Frozen White (WVZ)	CANFIBRE054-FW	\$3399.00
Magnetic Grey (WVQ)	CANFIBRE054-M	\$3399.00
Winning Blue (WVW)	CANFIBRE054-WB	\$3399.00
Blue Lightning (SW3)	CANFIBRE054-BL	\$3399.00
Ingot Silver (WVR)	CANFIBRE054-IS	\$3399.00
Shadow Black (UO)	CANFIBRE054-SB	\$3399.00
Arctic White (SWU)	CANFIBRE054-AW	\$3399.00

• Includes tub strengthening bracket (CANOPY010 BRACKET)

\* Pre-primed canopies, plus colour coding.

### CANOPY - PINNACLE 2 FIBREGLASS (SIDE LIFT UP WINDOWS AND CENTRAL LOCKING REAR DOOR) - FITS 4X4 AND 4X2 DUAL CAB MODELS

Pre-Primed	ICANOPY054-P	\$2899.00*
Aluminium Metallic (SWR) (38P)	ICANOPY054-AM	\$3399.00
Arctic White (SWU)	ICANOPY054-AW	\$3399.00
Blue Lightning (SW3)	ICANOPY054-BL	\$3399.00
Frozen White (WVZ)	ICANOPY054-FW	\$3399.00
Meteor Grey (42A) (SWT)	ICANOPY054-G	\$3399.00
Shadow Black (UO)	ICANOPY054-SB	\$3399.00

### TUB STRENGTHENING BRACKET

To suit all Canopies - (Must be fitted)	CANOPY010 BRACKET	\$51.00
---	-------------------	---------

### SLIDE-AWAY ROLL UP HARD TONNEAU COVER

Electric with Remote Control	ISLIDEAWAY054-E	\$2599.00
------------------------------	-----------------	-----------

### SEAT COVER

Canvas Comfort - Front	ICSC069F	\$401.00
Canvas Comfort - Rear	ICSC055R	\$401.00

### DIFF BREATHER KIT

Diff Breather Kit	IDIFFBRE	\$115.00
-------------------	----------	----------



9/2018+

# Ford Ranger Raptor

Product Description

Part No.

Qty  
Req

Retail  
ea Inc GST

## SUSPENSION TO SUIT FORD RANGER RAPTOR

### FRONT SUSPENSION

COIL SPRINGS	Est. Lift	Additional Load	Part No.	Qty	Retail
Light	30mm	0 - 50kg	<b>FOR007A</b>	1	\$250.00

### REAR SUSPENSION

COIL SPRINGS	Est. Lift	Additional Load	Part No.	Qty	Retail
Light	30mm	0 - 200kg	<b>FOR008A</b>	1	\$250.00





# Ford Ranger

Product Description

Part No.

Qty  
Req

Retail  
ea Inc GST

## ACCESSORIES TO SUIT FORD RANGER

### STEEL WINCH BULL BARS

Commercial - With parking sensor provisions Without Tech Pack	<b>BBC055</b>	\$1678.00
Commercial Deluxe - With parking sensor provisions Without Tech Pack	<b>BBCD055</b>	\$2284.00
Commercial Deluxe - With or Without Tech Pack	<b>BBCD066</b>	\$2284.00
Proguard No Loop - With or Without Tech Pack	<b>BBT066-NL</b>	\$1888.00
Proguard Single Loop Kit	<b>BB066-SL</b>	\$336.00
Proguard Triple Loop Kit	<b>BB066-TL</b>	\$404.00
Driving Light Patch Loom	<b>IPL066</b>	\$36.00

- Winch with Steel Cable and Roller Fairlead is not suitable for use with BBCD066 and BBT066 - Use Winch with Synthetic Rope and Alloy Hawse only
- Can also be fitted to both 2WD and 4WD models.

### STEEL SIDE STEPS AND RAILS - FITS DUAL CAB MODELS ONLY

Side Steps	<b>SS054</b>	\$962.00
Side Rails	<b>SS054 RAIL</b>	\$317.00
Side Steps and Rails	<b>SSR054</b>	\$1155.00

### TOWING

Class 4 Towbar - Compatible with Factory Rear Bumper (Not Wild Track)	<b>TB066</b>	\$581.00
Rear Protection Towbar - Full Rear Bumper Replacement	<b>RTB066</b>	\$1328.00
Rear Protection Towbar Plates (Pair)	<b>RTBPLATE001</b>	\$146.00
Towbar Wiring Loom - Plug and Play	<b>ITBL054</b>	\$337.00

### RECOVERY POINTS - IRONMAN 4X4 BULL BAR ONLY

Recovery Points - 5000kg Rating (Pair)	<b>IRP054</b>	\$325.00
--	---------------	----------

### SNORKEL

XL - (with side indicator)	<b>ISNORKEL034</b>	\$418.00
XLT - (with indicator on side mirror)	<b>ISNORKEL034XLT</b>	\$418.00

### BATTERY TRAY - DUAL CAB ONLY

Suits 10" Battery	<b>IBTRAY054</b>	\$192.00
-------------------	------------------	----------

### LONG RANGE FUEL TANK

140L* - Suitable for 3.2L Diesel Dual Cab, Extra Cab and Single Cab	<b>TANK007</b>	\$1129.00
---	----------------	-----------

\* Usable volume may differ to the stated tank capacity

### PREMIUM UNDERBODY PROTECTION

Engine Bay and Transmission - DPF Models (Retains factory transmission plate)	<b>UBP055</b>	\$526.00
---	---------------	----------

### LOCKSAFE DRAWER SYSTEMS - FITS DUAL AND EXTRA CAB

Twin Drawers - 1300mm	<b>ITD1300</b>	\$1469.00
Single Drawer - 1300mm	<b>ISD1300</b>	\$891.00
Wing Kit - 1300mm*	<b>ITDW037</b>	\$351.00

\*Designed to suit factory tubs, will not suit ute liner without modification.



# Ford Ranger

PX Mk III 8/2018+  
WITH or WITHOUT Tech Pack  
Adaptive Cruise Control



Product Description	Part No.	Qty Req	Retail ea Inc GST
<b>CANOPY - ABS PLASTIC (SIDE LIFT UP WINDOWS AND CENTRAL LOCKING REAR DOOR) - FITS 4X4 AND 4X2 DUAL CAB MODELS</b>			
Pre-Primed	CANOPY010-P †		\$3238.00*
Cool White (WVA) (A2W)	CANOPY010-CW		\$3856.00
Aurora Blue (WVD) (39A)	CANOPY010-AB		\$3856.00
Highlight Silver (18G)	CANOPY010-S		\$3856.00
Winning Blue (WVW)	CANOPY010-WB		\$3856.00
Magnetic Grey (WVQ)	CANOPY010-M †		\$3856.00
True Red (SWH)	CANOPY010-TR		\$3856.00
Meteor Grey (42A) (SWT)	CANOPY010-G †		\$3856.00
Frozen White (WVZ)	CANOPY010-FW †		\$3856.00
Metropolitan Grey (WVT) (36C)	CANOPY010-MG		\$3856.00
Aluminium Metallic (SWR)	CANOPY010-AM		\$3856.00
Ingot Silver (WVR)	CANOPY010-IS †		\$3856.00
Shadow Black (UO)	CANOPY010-SB †		\$3856.00
Blue Lightning (SW3)	CANOPY010-BL †		\$3856.00
Arctic White (SWU)	CANOPY010-AW †		\$3856.00
ABS Canopy Rack Feet	IRRFEEABS14		\$274.00
<ul style="list-style-type: none"> <li>• Includes tub strengthening bracket (CANOPY010 BRACKET)</li> <li>• Colour code and build date must be confirmed for Aluminium Metallic Canopies (CANOPY010-AM)</li> <li>• See Page 37 and 38 for 1.4m Roof Rack options and pricing.</li> </ul>			
* Pre-primed canopies, plus colour coding. († With central locking)			
<b>CANOPY - PINNACLE SMOOTH FINISH FIBREGLASS (SIDE LIFT UP WINDOWS AND CENTRAL LOCKING REAR DOOR) - FITS 4X4 AND 4X2 DUAL CAB MODELS</b>			
Pre-Primed	CANFIBRE054-P		\$2899.00*
Frozen White (WVZ)	CANFIBRE054-FW		\$3399.00
Magnetic Grey (WVQ)	CANFIBRE054-M		\$3399.00
Winning Blue (WVW)	CANFIBRE054-WB		\$3399.00
Blue Lightning (SW3)	CANFIBRE054-BL		\$3399.00
Ingot Silver (WVR)	CANFIBRE054-IS		\$3399.00
Shadow Black (UO)	CANFIBRE054-SB		\$3399.00
Arctic White (SWU)	CANFIBRE054-AW		\$3399.00
<ul style="list-style-type: none"> <li>• Includes tub strengthening bracket (CANOPY010 BRACKET)</li> </ul>			
* Pre-primed canopies, plus colour coding.			
<b>CANOPY - PINNACLE 2 FIBREGLASS (SIDE LIFT UP WINDOWS AND CENTRAL LOCKING REAR DOOR) - FITS 4X4 AND 4X2 DUAL CAB MODELS</b>			
Pre-Primed	ICANOPY054-P		\$2899.00*
Aluminium Metallic (SWR) (38P)	ICANOPY054-AM		\$3399.00
Arctic White (SWU)	ICANOPY054-AW		\$3399.00
Blue Lightning (SW3)	ICANOPY054-BL		\$3399.00
Frozen White (WVZ)	ICANOPY054-FW		\$3399.00
Meteor Grey (42A) (SWT)	ICANOPY054-G		\$3399.00
Shadow Black (UO)	ICANOPY054-SB		\$3399.00
<b>TUB STRENGTHENING BRACKET</b>			
To suit all Canopies - (Must be fitted)	CANOPY010 BRACKET		\$51.00
<b>SLIDE-AWAY ROLL UP HARD TONNEAU COVER</b>			
Electric with Remote Control	ISLIDEAWAY054-E		\$2599.00
<ul style="list-style-type: none"> <li>• Not suitable for Wildtrack models</li> </ul>			
<b>SEAT COVER</b>			
Canvas Comfort - Front	ICSC054F		\$401.00
Canvas Comfort - Rear	ICSC055R		\$401.00
<b>DIFF BREATHER KIT</b>			
Diff Breather Kit	IDIFFBRE		\$115.00

LISTING CONTINUED OVER THE PAGE





# Ford Ranger

Product Description

Part No.

Qty  
ReqRetail  
ea Inc GST

## SUSPENSION TO SUIT FORD RANGER

### FRONT SUSPENSION

#### SHOCK ABSORBER

Nitro Gas Strut - Performance			<b>12827GR</b>	2	\$222.00
Foam Cell Strut - Performance			<b>24827FE</b>	2	\$250.00
Foam Cell Pro Strut - Performance			<b>45827FE</b>	2	\$388.00

• Height adjustable with Ironman 4x4 Strut Trim Packers

#### COIL SPRINGS

	Est. Lift	Additional Load			
Standard	0mm	0 - 50kg	<b>FOR005S</b>	1	\$250.00
Light	35mm	0 - 50kg	<b>FOR005A</b>	1	\$250.00
Medium	40mm	0 - 50kg	<b>FOR005B</b>	1	\$250.00
Heavy	45mm	50 - 110kg	<b>FOR005C</b>	1	\$250.00

#### STRUT MOUNTS

Steel Strut Top			<b>ISST055</b>	2	\$97.00
Bump Stop Base Holder			<b>PBC055</b>	2	\$24.00

#### TRIM PACKERS

5mm Strut Trim Packer	Foam Cell		<b>HILFR05F</b>	2	\$28.00
10mm Strut Trim Packer	Foam Cell		<b>HILFR10F</b>	2	\$28.00
15mm Strut Trim Packer	Foam Cell		<b>HILFR15F</b>	2	\$28.00

• ONLY Compatible with Ironman 4x4 Struts (except Pro), lift height subject to 2:1 motion ratio. Unnecessary fitment may lift vehicle too high

#### SWAY BAR LINK

Adjustable Sway Bar Link			<b>1214K</b>	2	\$77.00
--------------------------	--	--	--------------	---	---------

#### CONTROL ARMS

Pro-Forge Upper Control Arms			<b>UCA054FA</b>	1	\$882.00
------------------------------	--	--	-----------------	---	----------

### REAR SUSPENSION

#### SHOCK ABSORBER

Nitro Gas - Comfort			<b>12095GRC</b>	2	\$153.00
Nitro Gas - Performance			<b>12095GR</b>	2	\$153.00
Foam Cell - Comfort			<b>24095FEC</b>	2	\$222.00
Foam Cell - Performance			<b>24095FE</b>	2	\$222.00
Foam Cell - Professional			<b>24095FEP</b>	2	\$222.00
Foam Cell Pro - Comfort			<b>45095FEC</b>	2	\$305.00
Foam Cell Pro - Performance			<b>45095FE</b>	2	\$305.00
Foam Cell Pro - Professional			<b>45095FEP</b>	2	\$305.00

#### LEAF SPRINGS

	Est. Lift	Additional Load			
Light	40mm	0 - 200kg	<b>FOR002A</b>	2	\$375.00
Medium	45mm	0 - 300kg	<b>FOR002B</b>	2	\$375.00
Heavy	45mm	300kg - GVM	<b>FOR002C</b>	2	\$402.00

• Possible driveline vibration may occur due to increased ride height, use 1194K to reduce vibration to satisfactory level

#### U-BOLTS

U-Bolt Kit			<b>417UBK</b>	2	\$42.00
------------	--	--	---------------	---	---------

#### POLYURETHANE SPRING BUSHES

Bush Kit			<b>1193UK</b>	1	\$167.00
----------	--	--	---------------	---	----------

#### DRIVELINE SPACERS

Centre Bearing Spacer Kit			<b>1194K</b>	1	\$42.00
---------------------------	--	--	--------------	---	---------

#### GREASABLE SHACKLES AND PINS

Greasable Shackle			<b>1147</b>	2	\$56.00
Non-Greasable Pin			<b>387-1</b>	2	\$28.00

#### HELPER SPRINGS

Load Plus Helper Springs			<b>LP3</b>	1	\$157.00
Add-A-Leaf			<b>ISL6010</b>	1	\$167.00



PX Mk III  
Not USA Model  
7/2018+

**SUSPENSION TO SUIT**

# Ford Ranger

**Product Description**

**Part No.**

**Qty  
Req**

**Retail  
ea Inc GST**

**SUSPENSION KIT**

Light - Nitro Gas	<b>FOR005AKG</b>	\$2037.00
Light - Foam Cell	<b>FOR005AKF</b>	\$2231.00
Light - Foam Cell Pro	<b>FOR005AKP</b>	\$2674.00
Medium - Nitro Gas	<b>FOR005BKG</b>	\$2037.00
Medium - Foam Cell	<b>FOR005BKF</b>	\$2231.00
Medium - Foam Cell Pro	<b>FOR005BKP</b>	\$2674.00
Heavy - Nitro Gas	<b>FOR005CKG</b>	\$2092.00
Heavy - Foam Cell	<b>FOR005CKF</b>	\$2286.00
Heavy - Foam Cell Pro	<b>FOR005CKP</b>	\$2729.00

• Specify front Coil Springs when ordering

• Possible driveline vibration may occur due to increased ride height, use 1194K to reduce vibration to satisfactory level

**SUSPENSION KIT CONTENTS**

Shock Absorbers	Coil Springs	U-Bolts	Centre Bearing Spacer Kit
Strut Shock Absorbers	Leaf Springs	Polyurethane Spring Bushes	



**OPTIONS AVAILABLE FOR THIS VEHICLE - SEE PAGE 378**







# Ford Ranger

Product Description

Part No.

Qty  
Req

Retail  
ea Inc GST

## ACCESSORIES TO SUIT FORD RANGER

### STEEL WINCH BULL BARS

Commercial - With parking sensor provisions Without Tech Pack	<b>BBC055</b>	\$1678.00
Commercial Deluxe - With parking sensor provisions Without Tech Pack	<b>BBCD055</b>	\$2284.00
Commercial Deluxe - With or Without Tech Pack	<b>BBCD054</b>	\$2284.00
Proguard No Loop - With or Without Tech Pack	<b>BBT054-NL</b>	\$1888.00
Proguard Single Loop Kit	<b>BB054-SL</b>	\$336.00
Proguard Triple Loop Kit	<b>BB054-TL</b>	\$404.00
Driving Light Patch Loom	<b>IPL066</b>	\$36.00

• Can also be fitted to both 2WD and 4WD models.

### STEEL SIDE STEPS AND RAILS - FITS DUAL AND SINGLE CAB MODELS ONLY

Side Steps	<b>SS054</b>	\$962.00
Side Rails	<b>SS054 RAIL</b>	\$317.00
Side Steps and Rails	<b>SSR054</b>	\$1155.00

### TOWING

Class 4 Towbar - Compatible with Factory Rear Bumper (Not Wild Track)	<b>TB066</b>	\$581.00
Rear Protection Towbar - Full Rear Bumper Replacement	<b>RTB066</b>	\$1328.00
Rear Protection Towbar Plates (Pair)	<b>RTBPLATE001</b>	\$146.00
Towbar Wiring Loom - Plug and Play	<b>ITBL054</b>	\$337.00

### RECOVERY POINTS - IRONMAN 4X4 BULL BAR ONLY

Recovery Points - 5000kg Rating (Pair)	<b>IRP054</b>	\$325.00
--	---------------	----------

### SNORKEL

XL - (with side indicator)	<b>ISNORKEL034</b>	\$418.00
XLT - (with indicator on side mirror)	<b>ISNORKEL034XLT</b>	\$418.00

### BATTERY TRAY- DUAL CAB ONLY

Suits 10" Battery	<b>IBTRAY054</b>	\$192.00
-------------------	------------------	----------

### LONG RANGE FUEL TANK

140L* - Suitable for 3.2L Diesel Dual Cab, Extra Cab and Single Cab	<b>TANK007</b>	\$1129.00
---	----------------	-----------

\* Usable volume may differ to the stated tank capacity

### PREMIUM UNDERBODY PROTECTION

Engine Bay and Transmission - Non DPF Models	<b>UBP054</b>	\$748.00
Engine Bay and Transmission - DPF Models (Retains factory transmission plate)	<b>UBP055</b>	\$526.00

### UNDERBODY PROTECTION

Engine Bay and Transmission - While Stocks Last	<b>IUP014K</b>	\$494.00
Fuel Tank - While Stocks Last	<b>IUP014F</b>	\$296.00

• Fuel tank protection plates are not compatible with long range fuel tanks.

### LOCKSAFE DRAWER SYSTEMS - FITS DUAL AND EXTRA CAB

Twin Drawers - 1300mm	<b>ITD1300</b>	\$1469.00
Single Drawer - 1300mm	<b>ISD1300</b>	\$891.00
Wing Kit - 1300mm*	<b>ITDW037</b>	\$351.00

\*Designed to suit factory tubs, will not suit ute liner without modification.



# Ford Ranger



PX Mk II 2015 to 7/2018  
WITH or WITHOUT Tech Pack  
Adaptive Cruise Control

Product Description	Part No.	Qty Req	Retail ea Inc GST
<b>CANOPY - ABS PLASTIC (SIDE LIFT UP WINDOWS AND CENTRAL LOCKING REAR DOOR) - FITS 4X4 AND 4X2 DUAL CAB MODELS</b>			
Pre-Primed	CANOPY010-P †		\$3238.00*
Cool White (WVA) (A2W)	CANOPY010-CW		\$3856.00
Aurora Blue (WVD) (39A)	CANOPY010-AB		\$3856.00
Highlight Silver (18G)	CANOPY010-S		\$3856.00
Winning Blue (WVV)	CANOPY010-WB		\$3856.00
Magnetic Grey (WVQ)	CANOPY010-M †		\$3856.00
True Red (SWH)	CANOPY010-TR		\$3856.00
Meteor Grey (42A) (SWT)	CANOPY010-G †		\$3856.00
Frozen White (WVZ)	CANOPY010-FW †		\$3856.00
Metropolitan Grey (WVT) (36C)	CANOPY010-MG		\$3856.00
Ingot Silver (WVR)	CANOPY010-IS †		\$3856.00
Shadow Black (UO)	CANOPY010-SB †		\$3856.00
Blue Lightning (SW3)	CANOPY010-BL †		\$3856.00
Arctic White (SWU)	CANOPY010-AW †		\$3856.00
ABS Canopy Rack Feet	IRRFEETABS14		\$274.00
<ul style="list-style-type: none"> <li>• Includes tub strengthening bracket (CANOPY010 BRACKET)</li> <li>• Colour code and build date must be confirmed for Aluminium Metallic Canopies (CANOPY010-AM)</li> <li>• See Page 37 and 38 for 1.4m Roof Rack options and pricing.</li> </ul>			
* Pre-primed canopies, plus colour coding. † With central locking			
<b>CANOPY - PINNACLE SMOOTH FINISH FIBREGLASS (SIDE LIFT UP WINDOWS AND CENTRAL LOCKING REAR DOOR) - FITS 4X4 AND 4X2 DUAL CAB MODELS</b>			
Pre-Primed	CANFIBRE054-P		\$2899.00*
Frozen White (WVZ)	CANFIBRE054-FW		\$3399.00
Magnetic Grey (WVQ)	CANFIBRE054-M		\$3399.00
Winning Blue (WVV)	CANFIBRE054-WB		\$3399.00
Blue Lightning (SW3)	CANFIBRE054-BL		\$3399.00
Ingot Silver (WVR)	CANFIBRE054-IS		\$3399.00
Shadow Black (UO)	CANFIBRE054-SB		\$3399.00
Arctic White (SWU)	CANFIBRE054-AW		\$3399.00
<ul style="list-style-type: none"> <li>• Includes tub strengthening bracket (CANOPY010 BRACKET)</li> </ul>			
* Pre-primed canopies, plus colour coding.			
<b>CANOPY - PINNACLE 2 FIBREGLASS (SIDE LIFT UP WINDOWS AND CENTRAL LOCKING REAR DOOR) - FITS 4X4 AND 4X2 DUAL CAB MODELS</b>			
Pre-Primed	ICANOPY054-P		\$2899.00*
Aluminium Metallic (SWR) (38P)	ICANOPY054-AM		\$3399.00
Arctic White (SWU)	ICANOPY054-AW		\$3399.00
Blue Lightning (SW3)	ICANOPY054-BL		\$3399.00
Frozen White (WVZ)	ICANOPY054-FW		\$3399.00
Meteor Grey (42A) (SWT)	ICANOPY054-G		\$3399.00
Shadow Black (UO)	ICANOPY054-SB		\$3399.00
<b>TUB STRENGTHENING BRACKET</b>			
To suit all Canopies - (Must be fitted)	CANOPY010 BRACKET		\$51.00
<b>SLIDE-AWAY ROLL UP HARD TONNEAU COVER</b>			
Electric with Remote Control	ISLIDEAWAY054-E		\$2599.00
• Not suitable for Wildtrack models			
<b>SEAT COVER</b>			
Canvas Comfort - Front	ICSC054F		\$401.00
Canvas Comfort - Rear	ICSC055R		\$401.00
<b>DIFF BREATHER KIT</b>			
Diff Breather Kit	IDIFFBRE		\$115.00

LISTING CONTINUED OVER THE PAGE





Product Description

Part No.

Qty  
Req

Retail  
ea Inc GST

## SUSPENSION TO SUIT FORD RANGER

### FRONT SUSPENSION

#### SHOCK ABSORBER

Nitro Gas Strut - Performance			<b>12727GR</b>	2	\$222.00
Foam Cell Strut - Performance			<b>24727FE</b>	2	\$250.00
Foam Cell Pro Strut - Performance			<b>45727FE</b>	2	\$388.00

• Height adjustable with Ironman 4x4 Strut Trim Packers

#### COIL SPRINGS

	Est. Lift	Additional Load			
Standard	0mm	0 - 50kg	<b>FOR001S</b>	1	\$250.00
Light	35mm	0 - 50kg	<b>FOR001A</b>	1	\$250.00
Medium	40mm	0 - 50kg	<b>FOR001B</b>	1	\$250.00
Heavy	45mm	50 - 110kg	<b>FOR001C</b>	1	\$250.00

#### STRUT MOUNTS

Steel Strut Top			<b>ISST014</b>	2	\$84.00
-----------------	--	--	----------------	---	---------

#### TRIM PACKERS

5mm Strut Trim Packer	Nitro Gas / Foam Cell	<b>HILFR05 / HILFR05F</b>	2	\$28.00
10mm Strut Trim Packer	Nitro Gas / Foam Cell	<b>HILFR10 / HILFR10F</b>	2	\$28.00
15mm Strut Trim Packer	Nitro Gas / Foam Cell	<b>HILFR15 / HILFR15F</b>	2	\$28.00

• ONLY Compatible with Ironman 4x4 Struts (except Pro), lift height subject to 2:1 motion ratio. Unnecessary fitment may lift vehicle too high

#### CONTROL ARMS

Pro-Forge Upper Control Arms		<b>UCA054FA</b>	1	\$882.00
------------------------------	--	-----------------	---	----------

#### SPACER KIT

Sway Bar Relocation Kit		<b>1203K</b>	1	\$97.00
-------------------------	--	--------------	---	---------

### REAR SUSPENSION

#### SHOCK ABSORBER

Nitro Gas - Comfort			<b>12095GRC</b>	2	\$153.00
Nitro Gas - Performance			<b>12095GR</b>	2	\$153.00
Foam Cell - Comfort			<b>24095FEC</b>	2	\$222.00
Foam Cell - Performance			<b>24095FE</b>	2	\$222.00
Foam Cell - Professional			<b>24095FEP</b>	2	\$222.00
Foam Cell Pro - Comfort			<b>45095FEC</b>	2	\$305.00
Foam Cell Pro - Performance			<b>45095FE</b>	2	\$305.00
Foam Cell Pro - Professional			<b>45095FEP</b>	2	\$305.00

#### LEAF SPRINGS

	Est. Lift	Additional Load			
Light	40mm	0 - 200kg	<b>FOR002A</b>	2	\$375.00
Medium	45mm	0 - 300kg	<b>FOR002B</b>	2	\$375.00
Heavy	45mm	300kg - GVM	<b>FOR002C</b>	2	\$402.00

• Possible driveline vibration may occur due to increased ride height, use 1194K to reduce vibration to satisfactory level

#### U-BOLTS

U-Bolt Kit		<b>417UBK</b>	2	\$42.00
------------	--	---------------	---	---------

#### POLYURETHANE SPRING BUSHES

Bush Kit		<b>1193UK</b>	1	\$167.00
----------	--	---------------	---	----------

#### DRIVELINE SPACERS

Centre Bearing Spacer Kit		<b>1194K</b>	1	\$42.00
---------------------------	--	--------------	---	---------

#### GREASABLE SHACKLES AND PINS

Greasable Shackle		<b>1147</b>	2	\$56.00
Non-Greasable Pin		<b>387-1</b>	2	\$28.00

#### HELPER SPRINGS

Load Plus Helper Springs		<b>LP3</b>	1	\$157.00
Add-A-Leaf		<b>ISL6010</b>	1	\$167.00







PX Mk II  
Not USA Model  
2015 to 6/2018

# Ford Ranger

Product Description

Part No.

Qty  
Req

Retail  
ea Inc GST

### SUSPENSION KIT

Light - Nitro Gas	FOR001AKG	\$2037.00
Light - Foam Cell	FOR001AKF	\$2231.00
Light - Foam Cell Pro	FOR001AKP	\$2674.00
Medium - Nitro Gas	FOR001BKG	\$2037.00
Medium - Foam Cell	FOR001BKF	\$2231.00
Medium - Foam Cell Pro	FOR001BKP	\$2674.00
Heavy - Nitro Gas	FOR001CKG	\$2092.00
Heavy - Foam Cell	FOR001CKF	\$2286.00
Heavy - Foam Cell Pro	FOR001CKP	\$2729.00

- Specify front Coil Springs when ordering
- Possible driveline vibration may occur due to increased ride height, use 1194K to reduce vibration to satisfactory level

### SUSPENSION KIT CONTENTS

Shock Absorbers	Coil Springs	U-Bolts	Centre Bearing Spacer Kit
Strut Shock Absorbers	Leaf Springs	Polyurethane Spring Bushes	



OPTIONS AVAILABLE FOR THIS VEHICLE - SEE PAGE 379



## Product Description

## Part No.

Qty  
ReqRetail  
ea Inc GST

## ACCESSORIES TO SUIT FORD RANGER

**STEEL WINCH BULL BARS**

Commercial	BBC038	\$1648.00
Commercial Deluxe	BBCD038	\$2244.00
Proguard No Loop	BBT038-NL	\$1855.00
Proguard Single Loop Kit	BB038-SL	\$336.00
Proguard Triple Loop Kit	BB038-TL	\$404.00
Driving Light Patch Loom	IPL066	\$36.00

• Can also be fitted to both 2WD and 4WD models.

**STEEL SIDE STEPS AND RAILS - FITS DUAL AND SINGLE CAB MODELS ONLY**

Side Steps	SS054	\$962.00
Side Rails	SS054 RAIL	\$317.00
Side Steps and Rails	SSR054	\$1155.00

**TOWING**

Class 4 Towbar - Compatible with Factory Rear Bumper (Not Wild Track)	TB066	\$581.00
Rear Protection Towbar - Full Rear Bumper Replacement	RTB066	\$1328.00
Rear Protection Towbar Plates (Pair)	RTBPLATE001	\$146.00
Towbar Wiring Loom - Plug and Play (PX 7/11 to 4/14 only)	ITBL039	\$366.00
Towbar Wiring Loom - Plug and Play (PX 4/14 to 7/15 only)	ITBL038	\$355.00

**RECOVERY POINTS - IRONMAN 4X4 BULL BAR ONLY**

Recovery Points - 5000kg Rating (Pair)	IRP054	\$325.00
--	--------	----------

**SNORKEL**

2.2 / 3.2L Diesel (Fits XL with side indicator)	ISNORKELO34	\$418.00
2.2 / 3.2L Diesel (Fits XLT with indicator on side mirror)	ISNORKELO34XLT	\$418.00

**BATTERY TRAYS**

Suits 10" Battery	IBTRAY054	\$192.00
-------------------	-----------	----------

**LONG RANGE FUEL TANK**

140L* - Suitable for 3.2L Diesel Dual Cab, Extra Cab and Single Cab	TANK007	\$1129.00
---	---------	-----------

\* Usable volume may differ to the stated tank capacity

**PREMIUM UNDERBODY PROTECTION**

Engine Bay and Transmission - Not compatible with models fitted with DPF	UBP054	\$748.00
--	--------	----------

**UNDERBODY PROTECTION**

Engine Bay and Transmission - <i>While Stocks Last</i>	IUP014K	\$494.00
Fuel Tank - <i>While Stocks Last</i>	IUP014F	\$296.00

• Fuel tank protection plates are not compatible with long range fuel tanks.

**LOCKSAFE DRAWER SYSTEMS**

Twin Drawers - 1300mm	ITD1300	\$1469.00
Single Drawer - 1300mm	ISD1300	\$891.00
Wing Kit - 1300mm*	ITDW037	\$351.00

\* Designed to suit factory tubs, will not suit ute liner without modification.

## Ford Ranger

PX  
7/2011 to 2015

## Product Description

## Part No.

Qty  
ReqRetail  
ea Inc GST**CANOPY - ABS PLASTIC (SIDE LIFT UP WINDOWS AND CENTRAL LOCKING REAR DOOR) - FITS 4X4 AND 4X2 DUAL CAB MODELS**

Pre-Primed	CANOPY010-P †	\$3238.00*
Cool White (WVA) (A2W)	CANOPY010-CW	\$3856.00
Aurora Blue (WVD) (39A)	CANOPY010-AB	\$3856.00
Highlight Silver (18G)	CANOPY010-S	\$3856.00
Winning Blue (WVW)	CANOPY010-WB	\$3856.00
Magnetic Grey (WVQ)	CANOPY010-M †	\$3856.00
True Red (SWH)	CANOPY010-TR	\$3856.00
Meteor Grey (42A) (SWT)	CANOPY010-G †	\$3856.00
Frozen White (WVZ)	CANOPY010-FW †	\$3856.00
Metropolitan Grey (WVT) (36C)	CANOPY010-MG	\$3856.00
Aluminium Metallic (SWR) (38P)	CANOPY010-AM	\$3856.00
Ingot Silver (WVR)	CANOPY010-IS †	\$3856.00
Shadow Black (UO)	CANOPY010-SB †	\$3856.00
Blue Lightning (SW3)	CANOPY010-BL †	\$3856.00
Arctic White (SWU)	CANOPY010-AW †	\$3856.00
ABS Canopy Rack Feet	IRRFETABS14	\$274.00

- Includes tub strengthening bracket (CANOPY010 BRACKET)

- Colour code and build date must be confirmed for Aluminium Metallic Canopies (CANOPY010-AM)

- See Page 37 and 38 for 1.4m Roof Rack options and pricing.

- \* Pre-primed canopies, plus colour coding. († With central locking)

**CANOPY - PINNACLE SMOOTH FINISH FIBREGLASS (SIDE LIFT UP WINDOWS AND CENTRAL LOCKING REAR DOOR) - FITS 4X4 AND 4X2 DUAL CAB MODELS**

Pre-Primed	CANFIBRE054-P	\$2899.00*
Frozen White (WVZ)	CANFIBRE054-FW	\$3399.00
Magnetic Grey (WVQ)	CANFIBRE054-M	\$3399.00
Winning Blue (WVW)	CANFIBRE054-WB	\$3399.00
Blue Lightning (SW3)	CANFIBRE054-BL	\$3399.00
Ingot Silver (WVR)	CANFIBRE054-IS	\$3399.00
Shadow Black (UP)	CANFIBRE054-SB	\$3399.00
Arctic White (SWU)	CANFIBRE054-AW	\$3399.00

- Includes tub strengthening bracket (CANOPY010 BRACKET)

- \* Pre-primed canopies, plus colour coding.

**CANOPY - PINNACLE 2 FIBREGLASS (SIDE LIFT UP WINDOWS AND CENTRAL LOCKING REAR DOOR) - FITS 4X4 AND 4X2 DUAL CAB MODELS**

Pre-Primed	ICANOPY054-P	\$2899.00*
Aluminium Metallic (SWR) (38P)	ICANOPY054-AM	\$3399.00
Arctic White (SWU)	ICANOPY054-AW	\$3399.00
Blue Lightning (SW3)	ICANOPY054-BL	\$3399.00
Frozen White (WVZ)	ICANOPY054-FW	\$3399.00
Meteor Grey (42A) (SWT)	ICANOPY054-G	\$3399.00
Shadow Black (UO)	ICANOPY054-SB	\$3399.00

**TUB STRENGTHENING BRACKET**

To suit all Canopies - (Must be fitted)

CANOPY010 BRACKET	\$51.00
-------------------	---------

**SLIDE-AWAY ROLL UP HARD TONNEAU COVER**

Electric with Remote Control

- Not suitable for Wildtrack models

ISLIDEAWAY054-E	\$2599.00
-----------------	-----------

**SEAT COVER**

Canvas Comfort - Front	ICSC038F	\$401.00
Canvas Comfort - Rear	ICSC038R	\$401.00

**DIFF BREATHER KIT**

Diff Breather Kit	IDIFFBRE	\$115.00
-------------------	----------	----------







Product Description

Part No.

Qty  
Req

Retail  
ea Inc GST

## SUSPENSION TO SUIT FORD RANGER

### FRONT SUSPENSION

#### SHOCK ABSORBER

Nitro Gas Strut - Performance			<b>12727GR</b>	2	\$222.00
Foam Cell Strut - Performance			<b>24727FE</b>	2	\$250.00
Foam Cell Pro Strut - Performance			<b>45727FE</b>	2	\$388.00

• Height adjustable with Ironman 4x4 Strut Trim Packers

#### COIL SPRINGS

	Est. Lift	Additional Load			
Standard	0mm	0 - 50kg	<b>FOR001S</b>	1	\$250.00
Light	35mm	0 - 50kg	<b>FOR001A</b>	1	\$250.00
Medium	40mm	0 - 50kg	<b>FOR001B</b>	1	\$250.00
Heavy	45mm	50 - 110kg	<b>FOR001C</b>	1	\$250.00

#### STRUT MOUNTS

Steel Strut Top			<b>ISST014</b>	2	\$84.00
-----------------	--	--	----------------	---	---------

#### TRIM PACKERS

5mm Strut Trim Packer	Nitro Gas / Foam Cell	<b>HILFR05 / HILFR05F</b>	2	\$28.00
10mm Strut Trim Packer	Nitro Gas / Foam Cell	<b>HILFR10 / HILFR10F</b>	2	\$28.00
15mm Strut Trim Packer	Nitro Gas / Foam Cell	<b>HILFR15 / HILFR15F</b>	2	\$28.00

• ONLY Compatible with Ironman 4x4 Struts (except Pro), lift height subject to 2:1 motion ratio. Unnecessary fitment may lift vehicle too high

#### CONTROL ARMS

Pro-Forge Upper Control Arms			<b>UCA054FA</b>	1	\$882.00
------------------------------	--	--	-----------------	---	----------

#### SPACER KIT

Sway Bar Relocation Kit			<b>1203K</b>	1	\$97.00
-------------------------	--	--	--------------	---	---------

### REAR SUSPENSION

#### SHOCK ABSORBER

Nitro Gas - Comfort			<b>12095GRC</b>	2	\$153.00
Nitro Gas - Performance			<b>12095GR</b>	2	\$153.00
Foam Cell - Comfort			<b>24095FEC</b>	2	\$222.00
Foam Cell - Performance			<b>24095FE</b>	2	\$222.00
Foam Cell - Professional			<b>24095FEP</b>	2	\$222.00
Foam Cell Pro - Comfort			<b>45095FEC</b>	2	\$305.00
Foam Cell Pro - Performance			<b>45095FE</b>	2	\$305.00
Foam Cell Pro - Professional			<b>45095FEP</b>	2	\$305.00

#### LEAF SPRINGS

	Est. Lift	Additional Load			
Light	40mm	0 - 200kg	<b>FOR002A</b>	2	\$375.00
Medium	45mm	0 - 300kg	<b>FOR002B</b>	2	\$375.00
Heavy	45mm	300kg - GVM	<b>FOR002C</b>	2	\$402.00

• Possible driveline vibration may occur due to increased ride height, use 1194K to reduce vibration to satisfactory level

#### U-BOLTS

U-Bolt Kit			<b>417UBK</b>	2	\$42.00
------------	--	--	---------------	---	---------

#### POLYURETHANE SPRING BUSHES

Bush Kit			<b>1193UK</b>	1	\$167.00
----------	--	--	---------------	---	----------

#### DRIVELINE SPACERS

Centre Bearing Spacer Kit			<b>1194K</b>	1	\$42.00
---------------------------	--	--	--------------	---	---------

#### GREASABLE SHACKLES AND PINS

Greasable Shackle			<b>1147</b>	2	\$56.00
Non-Greasable Pin			<b>387-1</b>	2	\$28.00

#### HELPER SPRINGS

Load Plus Helper Springs			<b>LP3</b>	1	\$157.00
Add-A-Leaf			<b>ISL6010</b>	1	\$167.00



T6 PX  
Not USA Model  
2011 to 2015

**SUSPENSION TO SUIT**

# Ford Ranger

Product Description

Part No.

Qty  
Req

Retail  
ea Inc GST

## SUSPENSION KIT

Light - Nitro Gas	FOR001AKG	\$2037.00
Light - Foam Cell	FOR001AKF	\$2231.00
Light - Foam Cell Pro	FOR001AKP	\$2674.00
Medium - Nitro Gas	FOR001BKG	\$2037.00
Medium - Foam Cell	FOR001BKF	\$2231.00
Medium - Foam Cell Pro	FOR001BKP	\$2674.00
Heavy - Nitro Gas	FOR001CKG	\$2092.00
Heavy - Foam Cell	FOR001CKF	\$2286.00
Heavy - Foam Cell Pro	FOR001CKP	\$2729.00

• Specify front Coil Springs when ordering

• Possible driveline vibration may occur due to increased ride height, use 1194K to reduce vibration to satisfactory level

## SUSPENSION KIT CONTENTS

Shock Absorbers	Coil Springs	U-Bolts	Centre Bearing Spacer Kit
Strut Shock Absorbers	Leaf Springs	Polyurethane Spring Bushes	



**OPTIONS AVAILABLE FOR THIS VEHICLE - SEE PAGE 379**



Product Description

Part No.

Qty  
Req

Retail  
ea Inc GST

## ACCESSORIES TO SUIT FORD RANGER

### STEEL WINCH BULL BARS

Commercial Deluxe	BBCD014	\$2244.00
Protector - <i>While Stocks Last</i>	BBT014	\$2271.00

• Can also be fitted to both 2WD and 4WD models.

### STEEL SIDE STEPS AND RAILS - FITS DUAL AND SINGLE CAB MODELS ONLY

Side Steps	SS008	\$962.00
Side Steps and Rails	SSR002	\$1155.00

### SNORKEL

3.0L TDi Diesel	ISNORKEL021	\$418.00
-----------------	-------------	----------

### EXHAUST SYSTEM - DIESEL ONLY

BigBore - (Automatic Transmission) - Diesel Only - <i>While Stocks Last</i>	IEXHAUST014	\$1301.00
BigBore - (Manual Transmission) - <i>While Stocks Last</i>	IEXHAUST015	\$1301.00

### LONG RANGE FUEL TANK

122L* Fits Dual and Single Cab only	TANK006	\$1129.00
-------------------------------------	---------	-----------

\* Usable volume may differ to the stated tank capacity

### UNDERBODY PROTECTION

Engine Bay and Transmission - <i>While Stocks Last</i>	IUP008K	\$437.00
--	---------	----------

### LOCKSAFE DRAWER SYSTEMS - FITS DUAL AND EXTRA CAB

Twin Drawers - 1300mm	ITD1300	\$1469.00
Single Drawer - 1300mm	ISD1300	\$891.00

### CANOPY - ABS PLASTIC (SIDE LIFT UP WINDOWS) - FITS 4X4 AND 4X2 DUAL CAB MODELS

Pre-Primed - <i>While Stocks Last</i>	CANOPY004-P	\$3238.00*
Ranger White (A2W) - <i>While Stocks Last</i>	CANOPY004-W	\$3856.00

• See Page 37 and 38 for 1.4m Roof Rack options and pricing.

\* Pre-primed canopies, plus colour coding.

### DIFF BREATHER KIT

Diff Breather Kit	IDIFFBRE	\$115.00
-------------------	----------	----------



## Ford Ranger

PJ / PK  
Not USA Model  
3/2006 to 2011

## Product Description

## Part No.

Qty  
ReqRetail  
ea Inc GST

## SUSPENSION TO SUIT FORD RANGER

## FRONT SUSPENSION

## SHOCK ABSORBER

Nitro Gas - Performance		<b>12667GR</b>	2	\$153.00
Foam Cell - Performance		<b>24667FE</b>	2	\$222.00
Foam Cell Pro - Performance		<b>45667FE</b>	2	\$305.00

## TORSION BAR

Uprated Torsion Bars	Duratorq Engine	<b>MAZDA014</b>	1	\$416.00
Uprated Torsion Bars	2.5L WLT Engine	<b>MAZDA005</b>	1	\$416.00

• MAZDA014 is 1024mm in length, used on most vehicles. Vehicles with 2.5L WLT Engine use MAZDA005 (924mm) Torsion Bar

• Minimum 60mm downward suspension travel required after adjustment

## REAR SUSPENSION

## SHOCK ABSORBER

Nitro Gas - Comfort		<b>12095GRC</b>	2	\$153.00
Nitro Gas - Performance		<b>12095GR</b>	2	\$153.00
Foam Cell - Comfort		<b>24095FEC</b>	2	\$222.00
Foam Cell - Performance		<b>24095FE</b>	2	\$222.00
Foam Cell Pro - Comfort		<b>45095FEC</b>	2	\$305.00
Foam Cell Pro - Performance		<b>45095FE</b>	2	\$305.00

## LEAF SPRINGS

	Est. Lift	Additional Load			
Light	40mm	0 - 100kg	<b>MAZDA041A</b>	2	\$375.00
Medium	40mm	0 - 200kg	<b>MAZDA041B</b>	2	\$375.00
Heavy	40mm	200 - 400kg	<b>MAZDA041C</b>	2	\$402.00
Extra Heavy	40mm	400kg - GVM	<b>MAZDA041D</b>	2	\$402.00

## U-BOLTS

U-Bolt Kit		<b>417UBK</b>	2	\$42.00
------------	--	---------------	---	---------

## POLYURETHANE SPRING BUSHES

Bush Kit		<b>759UK</b>	1	\$84.00
----------	--	--------------	---	---------

## GREASABLE SHACKLES AND PINS

Greasable Shackle		<b>386-1</b>	2	\$56.00
-------------------	--	--------------	---	---------

## HELPER SPRINGS

Load Plus Helper Springs		<b>LP3</b>	1	\$157.00
Add-A-Leaf		<b>ISL6010</b>	1	\$167.00

## SUSPENSION KIT

Light - Nitro Gas	<b>MAZDA041 AKG</b>	\$1940.00
Light - Foam Cell	<b>MAZDA041 AKF</b>	\$2217.00
Light - Foam Cell Pro	<b>MAZDA041 AKP</b>	\$2549.00
Medium - Nitro Gas	<b>MAZDA041 BKG</b>	\$1940.00
Medium - Foam Cell	<b>MAZDA041 BKF</b>	\$2217.00
Medium - Foam Cell Pro	<b>MAZDA041 BKP</b>	\$2549.00
Heavy - Nitro Gas	<b>MAZDA041 CKG</b>	\$1995.00
Heavy - Foam Cell	<b>MAZDA041 CKF</b>	\$2272.00
Heavy - Foam Cell Pro	<b>MAZDA041 CKP</b>	\$2605.00
Extra Heavy - Nitro Gas	<b>MAZDA041 DKG</b>	\$1995.00
Extra Heavy - Foam Cell	<b>MAZDA041 DKF</b>	\$2272.00
Extra Heavy - Foam Cell Pro	<b>MAZDA041 DKP</b>	\$2605.00

• Check Torsion Bar length before ordering.

## SUSPENSION KIT CONTENTS

Shock Absorbers  
Leaf Springs

Torsion Bars  
U-Bolts

Polyurethane Spring Bushes

# Ford Courier Ranger

Not USA Model  
1985 to 2006



Product Description

Part No.

Qty  
Req

Retail  
ea Inc GST

## SUSPENSION TO SUIT FORD COURIER

### FRONT SUSPENSION

#### SHOCK ABSORBER

Nitro Gas - Performance	<b>12667GR</b>	2	\$153.00
Foam Cell - Performance	<b>24667FE</b>	2	\$222.00
Foam Cell Pro - Performance	<b>45667FE</b>	2	\$305.00

#### TORSION BAR

Up-rated Torsion Bars	<b>MAZDA005</b>	1	\$416.00
-----------------------	-----------------	---	----------

• Minimum 60mm downward suspension travel required after adjustment

### REAR SUSPENSION

#### SHOCK ABSORBER

Nitro Gas - Comfort	<b>12095GRC</b>	2	\$153.00
Nitro Gas - Performance	<b>12095GR</b>	2	\$153.00
Foam Cell - Comfort	<b>24095FEC</b>	2	\$222.00
Foam Cell - Performance	<b>24095FE</b>	2	\$222.00
Foam Cell - Professional	<b>24095FEP</b>	2	\$222.00
Foam Cell Pro - Comfort	<b>45095FEC</b>	2	\$305.00
Foam Cell Pro - Performance	<b>45095FE</b>	2	\$305.00
Foam Cell Pro - Professional	<b>45095FEP</b>	2	\$305.00

#### LEAF SPRINGS

	Est. Lift	Additional Load			
Light	40mm	0 - 100kg	<b>MAZDA006A</b>	2	\$375.00
Medium	40mm	0 - 200kg	<b>MAZDA006B</b>	2	\$375.00
Heavy	40mm	200 - 400kg	<b>MAZDA006C</b>	2	\$375.00
Extra Heavy	40mm	400kg - GVM	<b>MAZDA006D</b>	2	\$402.00

#### U-BOLTS

U-Bolt Kit	<b>415UBK</b>	2	\$42.00
------------	---------------	---	---------

#### POLYURETHANE SPRING BUSHES

Bush Kit	<b>756UK</b>	1	\$84.00
----------	--------------	---	---------

#### GREASABLE SHACKLES AND PINS

Greasable Shackle	<b>386-1</b>	2	\$56.00
Greasable Pin	<b>794</b>	2	\$42.00

#### HELPER SPRINGS

Load Plus Helper Springs	<b>LP3</b>	1	\$157.00
Add-A-Leaf	<b>ISL6010</b>	1	\$167.00

### SUSPENSION KIT

Light - Nitro Gas	<b>MAZDA006AKG</b>	\$1940.00
Light - Foam Cell	<b>MAZDA006AKF</b>	\$2217.00
Light - Foam Cell Pro	<b>MAZDA006AKP</b>	\$2549.00
Medium - Nitro Gas	<b>MAZDA006BKG</b>	\$1940.00
Medium - Foam Cell	<b>MAZDA006BKF</b>	\$2217.00
Medium - Foam Cell Pro	<b>MAZDA006BKP</b>	\$2549.00
Heavy - Nitro Gas	<b>MAZDA006CKG</b>	\$1940.00
Heavy - Foam Cell	<b>MAZDA006CKF</b>	\$2217.00
Heavy - Foam Cell Pro	<b>MAZDA006CKP</b>	\$2549.00
Extra Heavy - Nitro Gas	<b>MAZDA006DKG</b>	\$1995.00
Extra Heavy - Foam Cell	<b>MAZDA006DKF</b>	\$2272.00
Extra Heavy - Foam Cell Pro	<b>MAZDA006DKP</b>	\$2605.00

### SUSPENSION KIT CONTENTS

Shock Absorbers  
Leaf Springs

Torsion Bars  
U-Bolts

Polyurethane Spring Bushes



UAll 7/2018+  
WITH or WITHOUT Tech Pack  
Adaptive Cruise Control

Product Description

Part No.

Qty  
ReqRetail  
ea Inc GST

## ACCESSORIES TO SUIT FORD EVEREST

### STEEL WINCH BULL BARS

Commercial - With parking sensor provisions Without Tech Pack	<b>BBC055</b>	\$1678.00
Commercial Deluxe - With parking sensor provisions Without Tech Pack	<b>BBCD055</b>	\$2284.00
Commercial Deluxe - With or Without Tech Pack	<b>BBCD066</b>	\$2284.00
Proguard No Loop - With or Without Tech Pack	<b>BBT066-NL</b>	\$1888.00
Proguard Single Loop Kit	<b>BB066-SL</b>	\$336.00
Proguard Triple Loop Kit	<b>BB066-TL</b>	\$404.00
Driving Light Patch Loom	<b>IPL066</b>	\$36.00

- Winch with Steel Cable and Roller Fairlead is not suitable for use with BBCD066 and BBT066 - Use Winch with Synthetic Rope and Alloy Hawse only
- Can also be fitted to both 2WD and 4WD models.

### STEEL SIDE STEPS AND RAILS

Side Steps	<b>SS055</b>	\$962.00
Side Rails	<b>SS055 RAIL</b>	\$317.00
Side Steps and Rails	<b>SSR055</b>	\$1155.00

### RECOVERY POINTS - IRONMAN 4X4 BULL BAR ONLY

Recovery Points - 5000kg Rating (Pair)	<b>IRP054</b>	\$325.00
--	---------------	----------

### PREMIUM UNDERBODY PROTECTION

Engine Bay and Transmission - DPF Models (Retains factory transmission plate)	<b>UBP055</b>	\$526.00
---	---------------	----------

### SEAT COVER

Canvas Comfort - Front	<b>ICSC054F</b>	\$401.00
Canvas Comfort - Rear	<b>ICSC054R</b>	\$401.00

### DIFF BREATHER KIT

Diff Breather Kit	<b>IDIFFBRE</b>	\$115.00
-------------------	-----------------	----------







Product Description

Part No.

Qty  
Req

Retail  
ea Inc GST

## SUSPENSION TO SUIT FORD EVEREST

### FRONT SUSPENSION

#### SHOCK ABSORBER

Nitro Gas Strut - Performance			<b>12827GR</b>	2	\$222.00
Foam Cell Strut - Performance			<b>24827FE</b>	2	\$250.00
Foam Cell Pro Strut - Performance			<b>45827FE</b>	2	\$388.00

• Height adjustable with Ironman 4x4 Strut Trim Packers

#### COIL SPRINGS

	Est. Lift	Additional Load			
Standard	0mm	0 - 50kg	<b>FOR005S</b>	1	\$250.00
Medium	40mm	0 - 50kg	<b>FOR005A</b>	1	\$250.00
Heavy	45mm	50 - 110kg	<b>FOR005B</b>	1	\$250.00

#### STRUT MOUNTS

Steel Strut Top			<b>ISST055</b>	2	\$97.00
Bump Stop Base Holder			<b>PBC055</b>	2	\$24.00

#### TRIM PACKERS

5mm Strut Trim Packer	Foam Cell		<b>HILFR05F</b>	2	\$28.00
10mm Strut Trim Packer	Foam Cell		<b>HILFR10F</b>	2	\$28.00
15mm Strut Trim Packer	Foam Cell		<b>HILFR15F</b>	2	\$28.00

• ONLY Compatible with Ironman 4x4 Struts (except Pro), lift height subject to 2:1 motion ratio. Unnecessary fitment may lift vehicle too high

#### SWAY BAR LINK

Adjustable Sway Bar Link			<b>1214K</b>	2	\$77.00
--------------------------	--	--	--------------	---	---------

#### CONTROL ARMS

Pro-Forge Upper Control Arms			<b>UCA054FA</b>	1	\$882.00
------------------------------	--	--	-----------------	---	----------

### REAR SUSPENSION

#### SHOCK ABSORBER

Nitro Gas - Performance <sup>1</sup>			<b>12732GR</b>	2	\$153.00
Foam Cell - Performance <sup>1</sup>			<b>24732FE</b>	2	\$222.00
Foam Cell Pro - Performance <sup>2</sup>			<b>45732FE</b>	2	\$305.00

<sup>1</sup> Refit original bump stop and shock absorber dust cover.

<sup>2</sup> Refit original bump stop with supplied Ironman 4x4 dust boot.

#### COIL SPRINGS

	Est. Lift	Additional Load			
Medium	45mm	0 - 300kg	<b>FOR003B</b>	1	\$291.00
Heavy	45mm	300kg - GVM	<b>FOR003C</b>	1	\$291.00

### SUSPENSION KIT

Medium - Nitro Gas	<b>FOR003BKG1</b>	\$1289.00
Medium - Foam Cell	<b>FOR003BKF1</b>	\$1483.00
Medium - Foam Cell Pro	<b>FOR003BKP1</b>	\$1926.00
Heavy - Nitro Gas	<b>FOR003CKG1</b>	\$1289.00
Heavy - Foam Cell	<b>FOR003CKF1</b>	\$1483.00
Heavy - Foam Cell Pro	<b>FOR003CKP1</b>	\$1926.00

• Specify front Coil Springs when ordering

### SUSPENSION KIT CONTENTS

Shock Absorbers

Strut Shock Absorbers

Coil Springs





9/2015 to 6/2018  
 WITH or WITHOUT Tech Pack  
 Adaptive Cruise Control

Product Description

Part No.

Qty  
Req

Retail  
ea Inc GST

**ACCESSORIES TO SUIT FORD EVEREST**

**STEEL WINCH BULL BARS**

Commercial - With parking sensor provisions Without Tech Pack	<b>BBC055</b>	\$1678.00
Commercial Deluxe - With parking sensor provisions Without Tech Pack	<b>BBCD055</b>	\$2284.00
Commercial Deluxe - With or Without Tech Pack	<b>BBCD054</b>	\$2284.00
Proguard No Loop - With or Without Tech Pack	<b>BBT054-NL</b>	\$1888.00
Proguard Single Loop Kit	<b>BB054-SL</b>	\$336.00
Proguard Triple Loop Kit	<b>BB054-TL</b>	\$404.00
Driving Light Patch Loom	<b>IPL066</b>	\$36.00

• Can also be fitted to both 2WD and 4WD models.

**STEEL SIDE STEPS AND RAILS**

Side Steps	<b>SS055</b>	\$962.00
Side Rails	<b>SS055 RAIL</b>	\$317.00
Side Steps and Rails	<b>SSR055</b>	\$1155.00

**RECOVERY POINTS - IRONMAN 4X4 BULL BAR ONLY**

Recovery Points - 5000kg Rating (Pair)	<b>IRP054</b>	\$325.00
--	---------------	----------

**PREMIUM UNDERBODY PROTECTION**

Engine Bay and Transmission	<b>UBP054</b>	\$748.00
-----------------------------	---------------	----------

**UNDERBODY PROTECTION**

Engine Bay and Transmission - <i>While Stocks Last</i>	<b>IUP014K</b>	\$494.00
--	----------------	----------

**SEAT COVER**

Canvas Comfort - Front	<b>ICSC054F</b>	\$401.00
Canvas Comfort - Rear	<b>ICSC054R</b>	\$401.00

**DIFF BREATHER KIT**

Diff Breather Kit	<b>IDIFFBRE</b>	\$115.00
-------------------	-----------------	----------

**LISTING  
CONTINUED  
OVER THE  
PAGE**





Product Description

Part No.

Qty  
Req

Retail  
ea Inc GST

## SUSPENSION TO SUIT FORD EVEREST

### FRONT SUSPENSION

#### SHOCK ABSORBER

Nitro Gas Strut - Performance			<b>12727GR</b>	2	\$222.00
Foam Cell Strut - Performance			<b>24727FE</b>	2	\$250.00
Foam Cell Pro Strut - Performance			<b>45727FE</b>	2	\$388.00

• Height adjustable with Ironman 4x4 Strut Trim Packers

#### COIL SPRINGS

	Est. Lift	Additional Load			
Standard	0mm	0 - 50kg	<b>FOR001S</b>	1	\$250.00
Medium	40mm	0 - 50kg	<b>FOR001A</b>	1	\$250.00
Heavy	40mm	50 - 100kg	<b>FOR001B</b>	1	\$250.00

#### STRUT MOUNTS

Steel Strut Top			<b>ISST014</b>	2	\$84.00
-----------------	--	--	----------------	---	---------

#### TRIM PACKERS

5mm Strut Trim Packer	Nitro Gas / Foam Cell	<b>HILFR05 / HILFR05F</b>	2	\$28.00
10mm Strut Trim Packer	Nitro Gas / Foam Cell	<b>HILFR10 / HILFR10F</b>	2	\$28.00
15mm Strut Trim Packer	Nitro Gas / Foam Cell	<b>HILFR15 / HILFR15F</b>	2	\$28.00

• ONLY Compatible with Ironman 4x4 Struts (except Pro), lift height subject to 2:1 motion ratio. Unnecessary fitment may lift vehicle too high

#### CONTROL ARMS

Pro-Forge Upper Control Arms			<b>UCA054FA</b>	1	\$882.00
------------------------------	--	--	-----------------	---	----------

### REAR SUSPENSION

#### SHOCK ABSORBER

Nitro Gas - Performance <sup>1</sup>			<b>12732GR</b>	2	\$153.00
Foam Cell - Performance <sup>1</sup>			<b>24732FE</b>	2	\$222.00
Foam Cell Pro - Performance <sup>2</sup>			<b>45732FE</b>	2	\$305.00

<sup>1</sup> Refit original bump stop and shock absorber dust cover.

<sup>2</sup> Refit original bump stop with supplied Ironman 4x4 dust boot.

#### COIL SPRINGS

	Est. Lift	Additional Load			
Medium	45mm	0 - 300kg	<b>FOR003B</b>	1	\$291.00
Heavy	45mm	300kg - GVM	<b>FOR003C</b>	1	\$291.00

### SUSPENSION KIT

Medium - Nitro Gas	<b>FOR003BKG</b>	\$1289.00
Medium - Foam Cell	<b>FOR003BKF</b>	\$1483.00
Medium - Foam Cell Pro	<b>FOR003BKP</b>	\$1926.00
Heavy - Nitro Gas	<b>FOR003CKG</b>	\$1289.00
Heavy - Foam Cell	<b>FOR003CKF</b>	\$1483.00
Heavy - Foam Cell Pro	<b>FOR003CKP</b>	\$1926.00

• Specify front Coil Springs when ordering

### SUSPENSION KIT CONTENTS

Shock Absorbers

Strut Shock Absorbers

Coil Springs







1500  
2019+

# GM / Chevrolet Silverado

Product Description

Part No.

Qty  
Req

Retail  
ea Inc GST

## ACCESSORIES TO SUIT GM / CHEVROLET SILVERADO

### SLIDE-AWAY ROLL UP HARD TONNEAU COVER

Electric with Remote Control (Long Bed)  
Electric with Remote Control (Short Bed)

ISLIDEAWAY087L-E  
ISLIDEAWAY087S-E

\$2699.00  
\$2599.00





Product Description

Part No.

Qty  
Req

Retail  
ea Inc GST

**SUSPENSION TO SUIT GM / HOLDEN JACKAROO**

**FRONT SUSPENSION**

**SHOCK ABSORBER**

Nitro Gas - Performance	<b>12643GR</b>	2	\$153.00
Foam Cell - Performance	<b>24643FE</b>	2	\$222.00

**TORSION BAR**

Up-rated Torsion Bars	<b>HOLD009</b>	1	\$416.00
-----------------------	----------------	---	----------

• Minimum 60mm downward suspension travel required after adjustment

**REAR SUSPENSION**

**SHOCK ABSORBER**

Nitro Gas - Performance	<b>12644GR</b>	2	\$153.00
Foam Cell - Performance	<b>24644FE</b>	2	\$222.00

**COIL SPRINGS**

	Est. Lift	Additional Load			
Medium	40mm	0 - 300kg	<b>HOLD008B</b>	1	\$250.00
Heavy	40mm	300kg - GVM	<b>HOLD008C</b>	1	\$250.00

• Use HOLD008C for 3/2001+ Models

**SUSPENSION KIT**

Medium - Nitro Gas	<b>HOLD008BKG</b>	\$1275.00
Medium - Foam Cell	<b>HOLD008BKF</b>	\$1552.00
Heavy - Nitro Gas	<b>HOLD008CKG</b>	\$1275.00
Heavy - Foam Cell	<b>HOLD008CKF</b>	\$1552.00

**SUSPENSION KIT CONTENTS**

Shock Absorbers

Coil Springs

Torsion Bars





11/1986 to 1991

# GM / Holden Jackaroo

Product Description

Part No.

Qty  
Req

Retail  
ea Inc GST

## SUSPENSION TO SUIT GM / HOLDEN JACKAROO

### FRONT SUSPENSION

#### SHOCK ABSORBER

Nitro Gas - Performance		<b>12087GR</b>	2	\$153.00
Foam Cell - Performance		<b>24087FE</b>	2	\$222.00

#### TORSION BAR

Uprated Torsion Bars	33mm Spline	<b>HOLD005A</b>	1	\$416.00
Uprated Torsion Bars	33mm Spline	<b>HOLD007</b>	1	\$693.00

• Minimum 60mm downward suspension travel required after adjustment

### REAR SUSPENSION

#### SHOCK ABSORBER

Nitro Gas - Performance		<b>12671GR</b>	2	\$153.00
-------------------------	--	----------------	---	----------

#### LEAF SPRINGS

	Est. Lift	Additional Load			
Medium - Drivers Side	40mm	0 - 300kg	<b>HOLD004BD/S</b>	1	\$375.00
Medium - Near Side	40mm	0 - 300kg	<b>HOLD004BN/S</b>	1	\$375.00
Heavy - Drivers Side	40mm	300kg - GVM	<b>HOLD004CD/S</b>	1	\$402.00
Heavy - Near Side	40mm	300kg - GVM	<b>HOLD004CN/S</b>	1	\$402.00

#### U-BOLTS

U-Bolt Kit		<b>451UBK</b>	2	\$42.00
------------	--	---------------	---	---------

#### POLYURETHANE SPRING BUSHES

Bush Kit		<b>747UK</b>	1	\$84.00
----------	--	--------------	---	---------

#### GREASABLE SHACKLES AND PINS

Greasable Shackle		<b>791</b>	2	\$56.00
Greasable Pin		<b>792</b>	2	\$42.00

#### HELPER SPRINGS

Load Plus Helper Springs		<b>LP3</b>	1	\$157.00
Add-A-Leaf		<b>ISL6010</b>	1	\$167.00

### SUSPENSION KIT

Medium - Nitro Gas		<b>HOLD007BKG</b>		\$2217.00
Medium - Foam Cell		<b>HOLD007BKF</b>		\$2355.00
Heavy - Nitro Gas		<b>HOLD007CKG</b>		\$1868.00
Heavy - Foam Cell		<b>HOLD007CKF</b>		\$2411.00

### SUSPENSION KIT CONTENTS

Shock Absorbers	Torsion Bars	Polyurethane Spring Bushes
Leaf Springs	U-Bolts	





Product Description

Part No.

Qty  
Req

Retail  
ea Inc GST

SUSPENSION TO SUIT GM / HOLDEN JACKAROO

FRONT SUSPENSION

SHOCK ABSORBER

Nitro Gas - Performance	12087GR	2	\$153.00
Foam Cell - Performance	24087FE	2	\$222.00

TORSION BAR

Up-rated Torsion Bars	MAZDA005	1	\$416.00
-----------------------	----------	---	----------

• Minimum 60mm downward suspension travel required after adjustment

REAR SUSPENSION

SHOCK ABSORBER

Nitro Gas - Comfort	12636GRC	2	\$153.00
Nitro Gas - Performance	12636GR	2	\$153.00
Foam Cell - Comfort	24636FEC	2	\$222.00
Foam Cell - Performance	24636FE	2	\$222.00

LEAF SPRINGS

	Est. Lift	Additional Load		
Medium - Drivers Side	40mm	0 - 300kg	HOLD004BD/S	1
Medium - Near Side	40mm	0 - 300kg	HOLD004BN/S	1
Heavy - Drivers Side	40mm	300kg - GVM	HOLD004CD/S	1
Heavy - Near Side	40mm	300kg - GVM	HOLD004CN/S	1

U-BOLTS

U-Bolt Kit	451UBK	2	\$42.00
------------	--------	---	---------

POLYURETHANE SPRING BUSHES

Bush Kit	747UK	1	\$84.00
----------	-------	---	---------

GREASABLE SHACKLES AND PINS

Greasable Shackle	791	2	\$56.00
Greasable Pin	792	2	\$42.00

HELPER SPRINGS

Load Plus Helper Springs	LP3	1	\$157.00
Add-A-Leaf	ISL6010	1	\$167.00

SUSPENSION KIT

Medium - Nitro Gas	HOLD005BKG	\$1940.00
Medium - Foam Cell	HOLD005BKF	\$2217.00
Heavy - Nitro Gas	HOLD005CKG	\$1995.00
Heavy - Foam Cell	HOLD005CKF	\$2272.00

SUSPENSION KIT CONTENTS

Shock Absorbers	Torsion Bars	Polyurethane Spring Bushes
Leaf Springs	U-Bolts	





1995 to 1/1999

# GM / Holden Frontera

Product Description

Part No.

Qty  
Req

Retail  
ea Inc GST

## SUSPENSION TO SUIT GM / HOLDEN JACKAROO

### FRONT SUSPENSION

#### SHOCK ABSORBER

Nitro Gas - Performance	<b>12667GR</b>	2	\$153.00
Foam Cell - Performance	<b>24667FE</b>	2	\$222.00

#### TORSION BAR

Uprated Torsion Bars	<b>HOLD009</b>	1	\$416.00
----------------------	----------------	---	----------

• Minimum 60mm downward suspension travel required after adjustment

### REAR SUSPENSION

#### SHOCK ABSORBER

Nitro Gas - Performance	<b>12644GR</b>	2	\$153.00
Foam Cell - Performance	<b>24644FE</b>	2	\$222.00

#### COIL SPRINGS

	Est. Lift	Additional Load		
Medium	45mm	0 - 300kg	<b>HOLD008B</b>	1
Heavy	45mm	300kg - GVM	<b>HOLD008C</b>	1

### SUSPENSION KIT

Medium - Nitro Gas	<b>HOLD008BKG1</b>	\$1275.00
Medium - Foam Cell	<b>HOLD008BKF1</b>	\$1552.00
Heavy - Nitro Gas	<b>HOLD008CKG1</b>	\$1275.00
Heavy - Foam Cell	<b>HOLD008CKF1</b>	\$1552.00

### SUSPENSION KIT CONTENTS

Shock Absorbers

Coil Springs

Torsion Bars



Product Description

Part No.

Qty  
ReqRetail  
ea Inc GST

## ACCESSORIES TO SUIT GM / HOLDEN TRAILBLAZER

**STEEL WINCH BULL BARS**

Commercial	BBC057	\$1678.00
Commercial Deluxe	BBCD057	\$2284.00
Proguard No Loop	BBT057-NL	\$1888.00
Proguard Single Loop Kit	BB057-SL	\$336.00
Proguard Triple Loop Kit	BB057-TL	\$404.00
Driving Light Patch Loom	IPL057	\$31.00

• Can also be fitted to both 2WD and 4WD models.

**STEEL SIDE STEPS AND RAILS - FITS DUAL CAB MODELS ONLY**

Side Steps	SS044	\$962.00
Side Rails	SS044 RAIL	\$317.00
Side Steps and Rails	SSR044	\$1155.00

**RECOVERY POINTS - IRONMAN 4X4 BULL BAR ONLY**

Recovery Points (One piece, two points) - 5000kg rating	IRP057	\$378.00
Recovery Points - 5000kg Rating (Pair)	IRP058	\$309.00

**SNORKEL**

Trailblazer LT/LTZ 2017+	ISNORKEL036	\$418.00
--------------------------	-------------	----------

**PREMIUM UNDERBODY PROTECTION**

Engine Bay and Transmission	UBP057	\$748.00
-----------------------------	--------	----------

**STEEL ROOF RACKS**

Cage Style - 1.8 x 1.25m	IRRCAGE18	\$815.00
Rooftop Tent Compatible - 1.8 x 1.25m	IRR TENT18	\$777.00
Trade Style - 1.8m x 1.25m (Open end)	IRR TRADE18	\$777.00

**ALLOY ROOF RACKS**

Cage Style - 1.8m x 1.25m	IRRCAGE18-ALLOY	\$1149.00
Trade Style - 1.8m x 1.25m (Open end)	IRR TRADE18-ALLOY	\$1132.00
Flat Rack - 1.8m x 1.25m	IRR FLAT18-ALLOY	\$1116.00

**ROOF RACK - MOUNTING KITS**

Mount Feet (6 Feet) - Suits OE rails	IRR FEET001	\$198.00
--------------------------------------	-------------	----------

**SEAT COVER**

Canvas Comfort - Front	ICSC040F	\$401.00
Canvas Comfort - Rear	ICSC049R	\$401.00

**DIFF BREATHER KIT**

Diff Breather Kit	IDIFFBRE	\$115.00
-------------------	----------	----------







LT / LTZ  
2017+

# GM / Holden Trailblazer

## Product Description

Part No.

Qty  
ReqRetail  
ea Inc GST

## SUSPENSION TO SUIT GM / HOLDEN TRAILBLAZER

### FRONT SUSPENSION

#### SHOCK ABSORBER

Nitro Gas Strut - Performance			<b>12745GR</b>	2	\$222.00
Foam Cell Strut - Performance			<b>24745FE</b>	2	\$250.00
Foam Cell Pro Strut - Performance			<b>45745FE</b>	2	\$388.00

• Height adjustable with Ironman 4x4 Strut Trim Packers

#### COIL SPRINGS

	Est. Lift	Additional Load			
Standard	0mm	0 - 50kg	<b>HOLD020S</b>	1	\$250.00
Light	30mm	0 - 50kg	<b>HOLD020A</b>	1	\$250.00
Medium	40mm	0 - 50kg	<b>HOLD020B</b>	1	\$250.00
Heavy	40mm	50 - 110kg	<b>HOLD020C</b>	1	\$250.00

#### STRUT MOUNTS

Steel Strut Top			<b>ISST017</b>	2	\$84.00
-----------------	--	--	----------------	---	---------

#### TRIM PACKERS

5mm Strut Trim Packer	Nitro Gas / Foam Cell	<b>HILFR05 / HILFR05F</b>	2	\$28.00
10mm Strut Trim Packer	Nitro Gas / Foam Cell	<b>HILFR10 / HILFR10F</b>	2	\$28.00
15mm Strut Trim Packer	Nitro Gas / Foam Cell	<b>HILFR15 / HILFR15F</b>	2	\$28.00

• ONLY Compatible with Ironman 4x4 Struts (except Pro), lift height subject to 2:1 motion ratio. Unnecessary fitment may lift vehicle too high

#### CONTROL ARMS

Pro-Forge Upper Control Arms			<b>UCA041FA</b>	1	\$882.00
------------------------------	--	--	-----------------	---	----------

### REAR SUSPENSION

#### SHOCK ABSORBER

Nitro Gas - Comfort			<b>12746GRC</b>	2	\$153.00
Nitro Gas - Performance			<b>12746GR</b>	2	\$153.00
Foam Cell - Comfort			<b>24746FEC</b>	2	\$222.00
Foam Cell - Performance			<b>24746FE</b>	2	\$222.00
Foam Cell Pro - Comfort			<b>45746FEC</b>	2	\$305.00
Foam Cell Pro - Performance			<b>45746FE</b>	2	\$305.00

#### COIL SPRINGS

	Est. Lift	Additional Load			
Standard	0mm	0 - 250kg	<b>HOLD022S</b>	1	\$250.00
Light	30mm	0 - 250kg	<b>HOLD022A</b>	1	\$250.00
Medium	40mm	0 - 250kg	<b>HOLD022B</b>	1	\$250.00
Heavy	45mm	250kg - GVM	<b>HOLD022C</b>	1	\$250.00

### SUSPENSION KIT

Standard - Nitro Gas	<b>HOLD022SKG</b>	\$1247.00
Standard - Foam Cell	<b>HOLD022SKF</b>	\$1441.00
Standard - Foam Cell Pro	<b>HOLD022SKP</b>	\$1884.00
Light - Nitro Gas	<b>HOLD022AKG</b>	\$1247.00
Light - Foam Cell	<b>HOLD022AKF</b>	\$1441.00
Light - Foam Cell Pro	<b>HOLD022AKP</b>	\$1884.00
Medium - Nitro Gas	<b>HOLD022BKG</b>	\$1247.00
Medium - Foam Cell	<b>HOLD022BKF</b>	\$1441.00
Medium - Foam Cell Pro	<b>HOLD022BKP</b>	\$1884.00
Heavy - Nitro Gas	<b>HOLD022CKG</b>	\$1247.00
Heavy - Foam Cell	<b>HOLD022CKF</b>	\$1441.00
Heavy - Foam Cell Pro	<b>HOLD022CKP</b>	\$1884.00

• Specify front Coil Springs when ordering

### SUSPENSION KIT CONTENTS

Shock Absorbers

Strut Shock Absorbers

Coil Springs



Product Description

Part No.

Qty  
Req

Retail  
ea Inc GST

**ACCESSORIES TO SUIT GM / HOLDEN COLORADO 7**

**STEEL WINCH BULL BARS**

Commercial Deluxe

BBCD044

\$2244.00

• Can also be fitted to both 2WD and 4WD models.

**STEEL SIDE STEPS AND RAILS**

Side Steps

SS044

\$962.00

Side Rails

SS044 RAIL

\$317.00

Side Steps and Rails

SSR044

\$1155.00

**RECOVERY POINTS - IRONMAN 4X4 BULL BAR ONLY**

Recovery Points - 5000kg Rating (Pair)

IRP058

\$309.00

**SNORKEL**

Colorado 7 RG 2012+

ISNORKELO36

\$418.00

**PREMIUM UNDERBODY PROTECTION**

Engine Bay and Transmission

UBP041

\$748.00

**STEEL ROOF RACKS**

Cage Style - 1.8 x 1.25m

IRRCAGE18

\$815.00

Rooftop Tent Compatible - 1.8 x 1.25m

IRRRTENT18

\$777.00

Trade Style - 1.8m x 1.25m (Open end)

IRRTRADE18

\$777.00

**ALLOY ROOF RACKS**

Cage Style - 1.8m x 1.25m

IRRCAGE18-ALLOY

\$1149.00

Trade Style - 1.8m x 1.25m (Open end)

IRRTRADE18-ALLOY

\$1132.00

Flat Rack - 1.8m x 1.25m

IRRFLAT18-ALLOY

\$1116.00

**ROOF RACK - MOUNTING KITS**

Mount Feet (6 Feet) - Suits OE rails

IRRFEET001

\$198.00

**SEAT COVER**

Canvas Comfort - Front

ICSC040F

\$401.00

Canvas Comfort - Rear

ICSC049R

\$401.00

**DIFF BREATHER KIT**

Diff Breather Kit

IDIFFBRE

\$115.00



Trailblazer  
2012+

## GM / Holden Colorado 7

Product Description

Part No.

Qty  
ReqRetail  
ea Inc GST

## SUSPENSION TO SUIT GM / HOLDEN COLORADO 7

## FRONT SUSPENSION

## SHOCK ABSORBER

Nitro Gas Strut - Performance			12745GR	2	\$222.00
Foam Cell Strut - Performance			24745FE	2	\$250.00
Foam Cell Pro Strut - Performance			45745FE	2	\$388.00

- Height adjustable with Ironman 4x4 Strut Trim Packers

## COIL SPRINGS

	Est. Lift	Additional Load			
Standard	0mm	0 - 50kg	HOLD020S	1	\$250.00
Light	30mm	0 - 50kg	HOLD020A	1	\$250.00
Medium	40mm	0 - 50kg	HOLD020B	1	\$250.00
Heavy	40mm	50 - 110kg	HOLD020C	1	\$250.00

## STRUT MOUNTS

Steel Strut Top			ISST017	2	\$84.00
-----------------	--	--	---------	---	---------

## TRIM PACKERS

5mm Strut Trim Packer	Nitro Gas / Foam Cell	HILFR05 / HILFR05F	2	\$28.00
10mm Strut Trim Packer	Nitro Gas / Foam Cell	HILFR10 / HILFR10F	2	\$28.00
15mm Strut Trim Packer	Nitro Gas / Foam Cell	HILFR15 / HILFR15F	2	\$28.00

- ONLY Compatible with Ironman 4x4 Struts (except Pro), lift height subject to 2:1 motion ratio. Unnecessary fitment may lift vehicle too high

## CONTROL ARMS

Pro-Forge Upper Control Arms			UCA041FA	1	\$882.00
------------------------------	--	--	----------	---	----------

## REAR SUSPENSION

## SHOCK ABSORBER

Nitro Gas - Comfort			12746GRC	2	\$153.00
Nitro Gas - Performance			12746GR	2	\$153.00
Foam Cell - Comfort			24746FEC	2	\$222.00
Foam Cell - Performance			24746FE	2	\$222.00
Foam Cell Pro - Comfort			45746FEC	2	\$305.00
Foam Cell Pro - Performance			45746FE	2	\$305.00

## COIL SPRINGS

	Est. Lift	Additional Load			
Standard	0mm	0 - 250kg	HOLD022S	1	\$250.00
Light	30mm	0 - 250kg	HOLD022A	1	\$250.00
Medium	40mm	0 - 250kg	HOLD022B	1	\$250.00
Heavy	45mm	250kg - GVM	HOLD022C	1	\$250.00

## SUSPENSION KIT

Standard - Nitro Gas	HOLD022SKG	\$1247.00
Standard - Foam Cell	HOLD022SKF	\$1441.00
Standard - Foam Cell Pro	HOLD022SKP	\$1884.00
Light - Nitro Gas	HOLD022AKG	\$1247.00
Light - Foam Cell	HOLD022AKF	\$1441.00
Light - Foam Cell Pro	HOLD022AKP	\$1884.00
Medium - Nitro Gas	HOLD022BKG	\$1247.00
Medium - Foam Cell	HOLD022BKF	\$1441.00
Medium - Foam Cell Pro	HOLD022BKP	\$1884.00
Heavy - Nitro Gas	HOLD022CKG	\$1247.00
Heavy - Foam Cell	HOLD022CKF	\$1441.00
Heavy - Foam Cell Pro	HOLD022CKP	\$1884.00

- Specify front Coil Springs when ordering

## SUSPENSION KIT CONTENTS

Shock Absorbers

Strut Shock Absorbers

Coil Springs





Product Description

Part No.

Qty  
Req

Retail  
ea Inc GST

## ACCESSORIES TO SUIT GM / HOLDEN COLORADO

### STEEL WINCH BULL BARS

Commercial	BBC057	\$1678.00
Commercial Deluxe	BBCD057	\$2284.00
Proguard No Loop	BBT057-NL	\$1888.00
Proguard Single Loop Kit	BB057-SL	\$336.00
Proguard Triple Loop Kit	BB057-TL	\$404.00
Driving Light Patch Loom	IPL057	\$31.00

• Can also be fitted to both 2WD and 4WD models.

### STEEL SIDE STEPS AND RAILS - FITS DUAL, SPACE AND SINGLE CAB MODELS ONLY

Side Steps	SS057	\$962.00
Side Rails	SS057 RAIL	\$317.00
Side Steps and Rails	SSR057	\$1155.00

### TOWING

Class 4 Towbar - Compatible with Factory Rear Bumper	TB040	\$581.00
Rear Protection Towbar - Full Rear Bumper Replacement	RTB040	\$1328.00
Rear Protection Towbar Plates (Pair)	RTBPLATE002	\$146.00
Towbar Wiring Loom - Plug and Play	ITBL040	\$337.00
Load Resistor Kit with Mounting Brackets for Licence Plate Lights	LR12V10W	\$49.00

### RECOVERY POINTS - IRONMAN 4X4 BULL BAR ONLY

Recovery Points (One piece, two points) - 5000kg rating	IRP057	\$378.00
Recovery Points - 5000kg Rating (Pair)	IRP058	\$309.00

### BATTERY TRAY

Suits 8" Battery	IBTRAY057	\$149.00
------------------	-----------	----------

### SNORKEL

Colorado RG 2016+	ISNORKEL036	\$418.00
-------------------	-------------	----------

### LONG RANGE FUEL TANK

145L* Diesel only - Fits Dual Cab Automatic Transmission only	TANK057	\$1129.00
---	---------	-----------

\* Usable volume may differ to the stated tank capacity

### EXHAUST SYSTEM

3" Exhaust Upgrade 2.0L - DPF Back - While Stocks Last	IEX057	\$770.00
--	--------	----------

### PREMIUM UNDERBODY PROTECTION

Engine Bay and Transmission	UBP057	\$748.00
-----------------------------	--------	----------

### LOCKSAFE DRAWER SYSTEMS

Twin Drawers - 1300mm	ITD1300	\$1469.00
Single Drawer - 1300mm	ISD1300	\$891.00
Wing Kit - 1300mm*	ITDW038	\$351.00

\*Designed to suit factory tubs, will not suit ute liner without modification

### CANOPY - ABS PLASTIC (SIDE LIFT UP WINDOWS AND CENTRAL LOCKING REAR DOOR) - FITS 4X4 AND 4X2 DUAL CAB MODELS

Pre-Primed	CANOPY019-P	\$3238.00*
Summit White (GAZ)	CANOPY019-SW	\$3856.00
Black (GBO)	CANOPY019-MB	\$3856.00
Blue (G8P)	CANOPY019-PB	\$3856.00
Steel Grey (GYM)	CANOPY019-G	\$3856.00
Silver (GAN)	CANOPY019-NS	\$3856.00
ABS Canopy Rack Feet	IRRFETABS14	\$274.00

• See Page 37 and 38 for 1.4m Roof Rack options and pricing.

\* Pre-primed canopies, plus colour coding.

### SEAT COVER

Canvas Comfort - Front	ICSC040F	\$401.00
Canvas Comfort - Rear	ICSC040R	\$401.00

### DIFF BREATHER KIT

Diff Breather Kit	IDIFFBRE	\$115.00
-------------------	----------	----------





RG  
2016 to 2020

# GM / Holden Colorado

Product Description

Part No.

Qty  
Req

Retail  
ea Inc GST

## SUSPENSION TO SUIT GM / HOLDEN COLORADO

### FRONT SUSPENSION

#### SHOCK ABSORBER

Nitro Gas Strut - Performance			<b>12745GR</b>	2	\$222.00
Foam Cell Strut - Performance			<b>24745FE</b>	2	\$250.00
Foam Cell Pro Strut - Performance			<b>45745FE</b>	2	\$388.00

• Height adjustable with Ironman 4x4 Strut Trim Packers

#### COIL SPRINGS

	Est. Lift	Additional Load			
Medium	40mm	0 - 50kg	<b>HOLD020A</b>	1	\$250.00
Heavy	40mm	50 - 110kg	<b>HOLD020B</b>	1	\$250.00

#### STRUT MOUNTS

Steel Strut Top			<b>ISST017</b>	2	\$84.00
-----------------	--	--	----------------	---	---------

#### TRIM PACKERS

5mm Strut Trim Packer	Nitro Gas / Foam Cell	<b>HILFR05 / HILFR05F</b>	2	\$28.00
10mm Strut Trim Packer	Nitro Gas / Foam Cell	<b>HILFR10 / HILFR10F</b>	2	\$28.00
15mm Strut Trim Packer	Nitro Gas / Foam Cell	<b>HILFR15 / HILFR15F</b>	2	\$28.00

• ONLY Compatible with Ironman 4x4 Struts (except Pro), lift height subject to 2:1 motion ratio. Unnecessary fitment may lift vehicle too high

#### CONTROL ARMS

Pro-Forge Upper Control Arms			<b>UCA041FA</b>	1	\$882.00
------------------------------	--	--	-----------------	---	----------

### REAR SUSPENSION

#### SHOCK ABSORBER

Nitro Gas - Comfort			<b>12636GRC</b>	2	\$153.00
Nitro Gas - Performance			<b>12636GR</b>	2	\$153.00
Nitro Gas - Professional			<b>12636GRP</b>	2	\$153.00
Foam Cell - Comfort			<b>24636FEC</b>	2	\$222.00
Foam Cell - Performance			<b>24636FE</b>	2	\$222.00
Foam Cell - Professional			<b>24636FEP</b>	2	\$222.00
Foam Cell Pro - Comfort			<b>45636FEC</b>	2	\$305.00
Foam Cell Pro - Performance			<b>45636FE</b>	2	\$305.00
Foam Cell Pro - Professional			<b>45636FEP</b>	2	\$305.00

#### LEAF SPRINGS

	Est. Lift	Additional Load			
Light	30mm	0 - 200kg	<b>HOLD021A</b>	2	\$402.00
Medium	45mm	0 - 300kg	<b>HOLD021B</b>	2	\$402.00
Heavy	45mm	300kg - 600kg	<b>HOLD021C</b>	2	\$416.00
Extra Heavy	45mm	600kg - GVM	<b>HOLD021D</b>	2	\$416.00

#### U-BOLTS

U-Bolt Kit			<b>437UBKL</b>	2	\$42.00
U-Bolt Kit	Suits HOLD021D		<b>678UBK</b>	2	\$42.00

#### POLYURETHANE SPRING BUSHES

Bush Kit			<b>770UK</b>	1	\$167.00
----------	--	--	--------------	---	----------

#### GREASABLE SHACKLES AND PINS

Greasable Shackle			<b>1148</b>	2	\$56.00
Non-Greasable Pin			<b>387-1</b>	2	\$28.00

#### HELPER SPRINGS

Add-A-Leaf			<b>ISL6010</b>	1	\$167.00
------------	--	--	----------------	---	----------

LISTING  
CONTINUED  
OVER THE  
PAGE

# GM / Holden Colorado

RG  
2016 to 2020



Product Description

Part No.

Qty  
Req

Retail  
ea Inc GST

## SUSPENSION KIT

Light - Nitro Gas	<b>HOLD021AKG1</b>	\$2064.00
Light - Foam Cell	<b>HOLD021AKF1</b>	\$2258.00
Light - Foam Cell Pro	<b>HOLD021AKP1</b>	\$2702.00
Medium - Nitro Gas	<b>HOLD021BKG1</b>	\$2064.00
Medium - Foam Cell	<b>HOLD021BKF1</b>	\$2258.00
Medium - Foam Cell Pro	<b>HOLD021BKP1</b>	\$2702.00
Heavy - Nitro Gas	<b>HOLD021CKG1</b>	\$2092.00
Heavy - Foam Cell	<b>HOLD021CKF1</b>	\$2286.00
Heavy - Foam Cell Pro	<b>HOLD021CKP1</b>	\$2729.00
Extra Heavy - Nitro Gas	<b>HOLD021DKG1</b>	\$2092.00
Extra Heavy - Foam Cell	<b>HOLD021DKF1</b>	\$2286.00
Extra Heavy - Foam Cell Pro	<b>HOLD021DKP1</b>	\$2729.00

• Specify front Coil Springs when ordering

## SUSPENSION KIT CONTENTS

Shock Absorbers  
Leaf Springs

Coil Springs  
U-Bolts

Polyurethane Spring Bushes  
Strut Shock Absorbers



**OPTIONS AVAILABLE FOR THIS VEHICLE - SEE PAGE 380**





RG  
2012 to 10/2016

# GM / Holden Colorado

Product Description

Part No.

Qty  
Req

Retail  
ea Inc GST

## ACCESSORIES TO SUIT GM / HOLDEN COLORADO

### STEEL WINCH BULL BARS

Commercial	BBC040	\$1648.00
Commercial Deluxe	BBCD040	\$2244.00
Driving Light Patch Loom	IPL057	\$31.00

• Can also be fitted to both 2WD and 4WD models.

### STEEL SIDE STEPS AND RAILS

Side Steps	SS057	\$962.00
Side Rails	SS057 RAIL	\$317.00
Side Steps and Rails	SSR057	\$1155.00

### TOWING

Class 4 Towbar - Compatible with Factory Rear Bumper	TB040	\$581.00
Rear Protection Towbar - Full Rear Bumper Replacement	RTB040	\$1328.00
Rear Protection Towbar Plates (Pair)	RTBPLATE002	\$146.00
Towbar Wiring Loom - Plug and Play	ITBL040	\$337.00

### RECOVERY POINTS - IRONMAN 4X4 BULL BAR ONLY

Recovery Points - 5000kg Rating (Pair)	IRP058	\$309.00
--	--------	----------

### SNORKEL

Colorado RG 2012-10/2016	ISNORKEL036	\$418.00
--------------------------	-------------	----------

### LONG RANGE FUEL TANK

145L* Diesel only - Fits Dual Cab only	TANK057	\$1129.00
--	---------	-----------

\* Usable volume may differ to the stated tank capacity

### EXHAUST SYSTEM

BigBore 2.8L Turbo Diesel - While Stocks Last	IEXHAUST017	\$1301.00
---	-------------	-----------

### PREMIUM UNDERBODY PROTECTION

Engine Bay and Transmission	UBP041	\$748.00
-----------------------------	--------	----------

### LOCKSAFE DRAWER SYSTEMS

Twin Drawers - 1300mm	ITD1300	\$1469.00
Single Drawer - 1300mm	ISD1300	\$891.00
Wing Kit - 1300mm*	ITDW038	\$351.00

\* Designed to suit factory tubs, will not suit ute liner without modification

### CANOPY - ABS PLASTIC (SIDE LIFT UP WINDOWS AND CENTRAL LOCKING REAR DOOR) - FITS 4X4 AND 4X2 DUAL CAB MODELS

Pre-Primed	CANOPY019-P	\$3238.00*
Summit White (GAZ)	CANOPY019-SW †	\$3856.00
Oceanic Blue (774U)	CANOPY019-B	\$3856.00
Black Sapphire (2HU)	CANOPY019-BS	\$3856.00
Silver (636R)	CANOPY019-S	\$3856.00
ABS Canopy Rack Feet	IRRFEEABS14	\$274.00

• See Page 37 and 38 for 1.4m Roof Rack options and pricing.

\* Pre-primed canopies, plus colour coding. († With central locking)

### SEAT COVER

Canvas Comfort - Front	ICSC040F	\$401.00
Canvas Comfort - Rear	ICSC040R	\$401.00

### DIFF BREATHER KIT

Diff Breather Kit	IDIFFBRE	\$115.00
-------------------	----------	----------





Product Description

Part No.

Qty  
Req

Retail  
ea Inc GST

SUSPENSION TO SUIT GM / HOLDEN COLORADO

FRONT SUSPENSION

SHOCK ABSORBER

Nitro Gas Strut - Performance			<b>12745GR</b>	2	\$222.00
Foam Cell Strut - Performance			<b>24745FE</b>	2	\$250.00
Foam Cell Pro Strut - Performance			<b>45745FE</b>	2	\$388.00

• Height adjustable with Ironman 4x4 Strut Trim Packers

COIL SPRINGS

	Est. Lift	Additional Load			
Standard	0mm	0 - 50kg	<b>HOLD020S</b>	1	\$250.00
Light	30mm	0 - 50kg	<b>HOLD020A</b>	1	\$250.00
Medium	40mm	0 - 50kg	<b>HOLD020B</b>	1	\$250.00
Heavy	40mm	50 - 110kg	<b>HOLD020C</b>	1	\$250.00

STRUT MOUNTS

Steel Strut Top			<b>ISST017</b>	2	\$84.00
-----------------	--	--	----------------	---	---------

TRIM PACKERS

5mm Strut Trim Packer	Nitro Gas / Foam Cell	<b>HILFR05 / HILFR05F</b>	2	\$28.00
10mm Strut Trim Packer	Nitro Gas / Foam Cell	<b>HILFR10 / HILFR10F</b>	2	\$28.00
15mm Strut Trim Packer	Nitro Gas / Foam Cell	<b>HILFR15 / HILFR15F</b>	2	\$28.00

• ONLY Compatible with Ironman 4x4 Struts (except Pro), lift height subject to 2:1 motion ratio. Unnecessary fitment may lift vehicle too high

CONTROL ARMS

Pro-Forge Upper Control Arms			<b>UCA041FA</b>	1	\$882.00
------------------------------	--	--	-----------------	---	----------

REAR SUSPENSION

SHOCK ABSORBER

Nitro Gas - Comfort			<b>12636GRC</b>	2	\$153.00
Nitro Gas - Performance			<b>12636GR</b>	2	\$153.00
Nitro Gas - Professional			<b>12636GRP</b>	2	\$153.00
Foam Cell - Comfort			<b>24636FEC</b>	2	\$222.00
Foam Cell - Performance			<b>24636FE</b>	2	\$222.00
Foam Cell - Professional			<b>24636FEP</b>	2	\$222.00
Foam Cell Pro - Comfort			<b>45636FEC</b>	2	\$305.00
Foam Cell Pro - Performance			<b>45636FE</b>	2	\$305.00
Foam Cell Pro - Professional			<b>45636FEP</b>	2	\$305.00

LEAF SPRINGS

	Est. Lift	Additional Load			
Light	30mm	0 - 200kg	<b>HOLD021A</b>	2	\$402.00
Medium	45mm	0 - 300kg	<b>HOLD021B</b>	2	\$402.00
Heavy	45mm	300kg - 600kg	<b>HOLD021C</b>	2	\$416.00
Extra Heavy	45mm	600kg - GVM	<b>HOLD021D</b>	2	\$416.00

U-BOLTS

U-Bolt Kit			<b>437UBKL</b>	2	\$42.00
U-Bolt Kit	Suits HOLD021D		<b>678UBK</b>	2	\$42.00

POLYURETHANE SPRING BUSHES

Bush Kit			<b>770UK</b>	1	\$167.00
----------	--	--	--------------	---	----------

GREASABLE SHACKLES AND PINS

Greasable Shackle			<b>1148</b>	2	\$56.00
Non-Greasable Pin			<b>387-1</b>	2	\$28.00

HELPER SPRINGS

Add-A-Leaf			<b>ISL6010</b>	1	\$167.00
------------	--	--	----------------	---	----------





RG  
2012 to 2016

# GM / Holden Colorado

Product Description

Part No.

Qty  
Req

Retail  
ea Inc GST

### SUSPENSION KIT

Light - Nitro Gas	HOLD021AKG	\$2064.00
Light - Foam Cell	HOLD021AKF	\$2258.00
Light - Foam Cell Pro	HOLD021AKP	\$2702.00
Medium - Nitro Gas	HOLD021BKG	\$2064.00
Medium - Foam Cell	HOLD021BKF	\$2258.00
Medium - Foam Cell Pro	HOLD021BKP	\$2702.00
Heavy - Nitro Gas	HOLD021CKG	\$2092.00
Heavy - Foam Cell	HOLD021CKF	\$2286.00
Heavy - Foam Cell Pro	HOLD021CKP	\$2729.00
Extra Heavy - Nitro Gas	HOLD021DKG	\$2092.00
Extra Heavy - Foam Cell	HOLD021DKF	\$2286.00
Extra Heavy - Foam Cell Pro	HOLD021DKP	\$2729.00

• Specify front Coil Springs when ordering

### SUSPENSION KIT CONTENTS

Shock Absorbers  
Leaf Springs

Coil Springs  
U-Bolts

Polyurethane Spring Bushes  
Brake Hose Relocation Kit

Strut Shock Absorbers



OPTIONS AVAILABLE FOR THIS VEHICLE - SEE PAGE 380



Product Description

Part No.

Qty  
Req

Retail  
ea Inc GST

**SUSPENSION TO SUIT GM / HOLDEN COLORADO**

**FRONT SUSPENSION**

**SHOCK ABSORBER**

Nitro Gas Strut - Performance **12797GR** 2 \$222.00

• Height adjustable with Ironman 4x4 Strut Trim Packers

**COIL SPRINGS**

	Est. Lift	Additional Load	Part No.	Qty	Price
Medium	35mm	0 - 50kg	<b>TOY038B</b>	1	\$250.00
Heavy	35mm	50 - 110kg	<b>TOY038C</b>	1	\$250.00

**TRIM PACKERS**

5mm Strut Trim Packer	Nitro Gas / Foam Cell	<b>HILFR05 / HILFR05F</b>	2	\$28.00
10mm Strut Trim Packer	Nitro Gas / Foam Cell	<b>HILFR10 / HILFR10F</b>	2	\$28.00
15mm Strut Trim Packer	Nitro Gas / Foam Cell	<b>HILFR15 / HILFR15F</b>	2	\$28.00

• ONLY Compatible with Ironman 4x4 Struts (except Pro), lift height subject to 2:1 motion ratio. Unnecessary fitment may lift vehicle too high

**REAR SUSPENSION**

**SHOCK ABSORBER**

Nitro Gas - Comfort	<b>12636GRC</b>	2	\$153.00
Nitro Gas - Performance	<b>12636GR</b>	2	\$153.00
Nitro Gas - Professional	<b>12636GRP</b>	2	\$153.00
Foam Cell - Comfort	<b>24636FEC</b>	2	\$222.00
Foam Cell - Performance	<b>24636FE</b>	2	\$222.00
Foam Cell - Professional	<b>24636FEP</b>	2	\$222.00

**LEAF SPRINGS**

	Est. Lift	Additional Load	Part No.	Qty	Price
Medium	45mm	0 - 300kg	<b>HOLD023B</b>	2	\$375.00
Heavy	45mm	300kg - 600kg	<b>HOLD023C</b>	2	\$402.00

**U-BOLTS**

U-Bolt Kit **417UBK** 2 \$42.00

**POLYURETHANE SPRING BUSHES**

Bush Kit **728UK** 1 \$84.00

**GREASABLE SHACKLES AND PINS**

Greasable Shackle **386-2** 2 \$56.00

**HELPER SPRINGS**

Add-A-Leaf **ISL6010** 1 \$167.00

**SUSPENSION KIT**

Medium - Nitro Gas	<b>HOLD023BKG</b>	\$1912.00
Heavy - Nitro Gas	<b>HOLD023CKG</b>	\$1967.00

• Specify front Coil Springs when ordering

**SUSPENSION KIT CONTENTS**

Shock Absorbers	Coil Springs	Polyurethane Spring Bushes
Leaf Springs	U-Bolts	Strut Shock Absorbers







RC  
7/2008 to 12/2012

# GM / Holden Colorado

Product Description

Part No.

Qty  
Req

Retail  
ea Inc GST

## ACCESSORIES TO SUIT GM / HOLDEN COLORADO

### STEEL WINCH BULL BARS

Commercial Deluxe	BBCD027	\$2244.00
Protector - <i>While Stocks Last</i>	BBT027	\$2271.00

• Can also be fitted to both 2WD and 4WD models.

### STEEL SIDE STEPS AND RAILS - FITS DUAL CAB MODELS ONLY

Side Steps	SS001	\$962.00
Side Steps and Rails	SSR006	\$1155.00

### SNORKEL

Colorado RC 7/2008 to 12/2012	ISNORKEL028	\$418.00
-------------------------------	-------------	----------

### UNDERBODY PROTECTION

Engine Bay and Transmission - <i>While Stocks Last</i>	IUP009K	\$563.00
--	---------	----------

### LOCKSAFE DRAWER SYSTEMS

Twin Drawers - 1300mm	ITD1300	\$1469.00
Single Drawer - 1300mm	ISD1300	\$891.00

### DIFF BREATHER KIT

Diff Breather Kit	IDIFFBRE	\$115.00
-------------------	----------	----------

**LISTING  
CONTINUED  
OVER THE  
PAGE**





Product Description

Part No.

Qty  
Req

Retail  
ea Inc GST

**SUSPENSION TO SUIT GM / HOLDEN COLORADO**

**FRONT SUSPENSION**

**SHOCK ABSORBER**

Nitro Gas - Performance	<b>12667GR</b>	2	\$153.00
Foam Cell - Performance	<b>24667FE</b>	2	\$222.00

**TORSION BAR**

Up-rated Torsion Bars	<b>HOLD010</b>	1	\$416.00
-----------------------	----------------	---	----------

• Minimum 60mm downward suspension travel required after adjustment

**REAR SUSPENSION**

**SHOCK ABSORBER**

Nitro Gas - Comfort	<b>12636GRC</b>	2	\$153.00
Nitro Gas - Performance	<b>12636GR</b>	2	\$153.00
Nitro Gas - Professional	<b>12636GRP</b>	2	\$153.00
Foam Cell - Comfort	<b>24636FEC</b>	2	\$222.00
Foam Cell - Performance	<b>24636FE</b>	2	\$222.00
Foam Cell - Professional	<b>24636FEP</b>	2	\$222.00

**LEAF SPRINGS**

	Est. Lift	Additional Load			
Medium	40mm	0 - 300kg	<b>HOLD006B</b>	2	\$375.00
Heavy	40mm	300kg - 600kg	<b>HOLD006C</b>	2	\$402.00
Extra Heavy	40mm	600 kg - GVM	<b>HOLD006D</b>	2	\$402.00

**U-BOLTS**

U-Bolt Kit	<b>417UBK</b>	2	\$42.00
------------	---------------	---	---------

**POLYURETHANE SPRING BUSHES**

Bush Kit	<b>728TUK</b>	1	\$84.00
----------	---------------	---	---------

**GREASABLE SHACKLES AND PINS**

Greasable Shackle	<b>386-2</b>	2	\$56.00
Non-Greasable Pin	<b>387-1</b>	2	\$28.00

**HELPER SPRINGS**

Add-A-Leaf	<b>ISL6010</b>	1	\$167.00
------------	----------------	---	----------

• Load Plus not suitable for Rodeo / Colorado / D-Max with OEM springs due to interleaf liners

**SUSPENSION KIT**

Medium - Nitro Gas	<b>HOLD006BKG</b>	\$1940.00
Medium - Foam Cell	<b>HOLD006BKF</b>	\$2217.00
Heavy - Nitro Gas	<b>HOLD006CKG</b>	\$1995.00
Heavy - Foam Cell	<b>HOLD006CKF</b>	\$2272.00
Extra Heavy - Nitro Gas	<b>HOLD006DKG</b>	\$1995.00
Extra Heavy - Foam Cell	<b>HOLD006DKF</b>	\$2272.00

**SUSPENSION KIT CONTENTS**

Shock Absorbers	Torsion Bars	Polyurethane Spring Bushes
Leaf Springs	U-Bolts	





RA7  
2007 to 7/2008

# GM / Holden Rodeo

Product Description

Part No.

Qty  
Req

Retail  
ea Inc GST

## ACCESSORIES TO SUIT GM / HOLDEN RODEO

### STEEL WINCH BULL BARS

Commercial Deluxe

BBCD020

\$2244.00

• Can also be fitted to both 2WD and 4WD models.

### STEEL SIDE STEPS AND RAILS - FITS DUAL CAB MODELS ONLY

Side Steps

SS001

\$962.00

Side Steps and Rails

SSR006

\$1155.00

### SNORKEL

LX and LT (Does not fit DX model)

ISNORKEL022

\$418.00

### UNDERBODY PROTECTION

Engine Bay and Transmission - *While Stocks Last*

IUP009K

\$563.00

### LOCKSAFE DRAWER SYSTEMS

Twin Drawers - 1300mm

ITD1300

\$1469.00

Single Drawer - 1300mm

ISD1300

\$891.00

### DIFF BREATHER KIT

Diff Breather Kit

IDIFFBRE

\$115.00

LISTING  
CONTINUED  
OVER THE  
PAGE



Product Description

Part No.

Qty  
Req

Retail  
ea Inc GST

**SUSPENSION TO SUIT GM / HOLDEN RODEO**

**FRONT SUSPENSION**

**SHOCK ABSORBER**

Nitro Gas - Performance	<b>12667GR</b>	2	\$153.00
Foam Cell - Performance	<b>24667FE</b>	2	\$222.00

**TORSION BAR**

Up-rated Torsion Bars	<b>HOLD010</b>	1	\$416.00
-----------------------	----------------	---	----------

• Minimum 60mm downward suspension travel required after adjustment

**REAR SUSPENSION**

**SHOCK ABSORBER**

Nitro Gas - Comfort	<b>12636GRC</b>	2	\$153.00
Nitro Gas - Performance	<b>12636GR</b>	2	\$153.00
Nitro Gas - Professional	<b>12636GRP</b>	2	\$153.00
Foam Cell - Comfort	<b>24636FEC</b>	2	\$222.00
Foam Cell - Performance	<b>24636FE</b>	2	\$222.00
Foam Cell - Professional	<b>24636FEP</b>	2	\$222.00

**LEAF SPRINGS**

	Est. Lift	Additional Load			
Medium	40mm	0 - 300kg	<b>HOLD006B</b>	2	\$375.00
Heavy	40mm	300kg - 600kg	<b>HOLD006C</b>	2	\$402.00
Extra Heavy	40mm	600 kg - GVM	<b>HOLD006D</b>	2	\$402.00

**U-BOLTS**

U-Bolt Kit	<b>417UBK</b>	2	\$42.00
------------	---------------	---	---------

**POLYURETHANE SPRING BUSHES**

Bush Kit	<b>728TUK</b>	1	\$84.00
----------	---------------	---	---------

**GREASABLE SHACKLES AND PINS**

Greasable Shackle	<b>386-2</b>	2	\$56.00
Non-Greasable Pin	<b>387-1</b>	2	\$28.00

**HELPER SPRINGS**

Add-A-Leaf	<b>ISL6010</b>	1	\$167.00
------------	----------------	---	----------

• Load Plus not suitable for Rodeo / Colorado / D-Max with OEM springs due to interleaf liners

**SUSPENSION KIT**

Medium - Nitro Gas	<b>HOLD006BKG</b>	\$1940.00
Medium - Foam Cell	<b>HOLD006BKF</b>	\$2217.00
Heavy - Nitro Gas	<b>HOLD006CKG</b>	\$1995.00
Heavy - Foam Cell	<b>HOLD006CKF</b>	\$2272.00
Extra Heavy - Nitro Gas	<b>HOLD006DKG</b>	\$1995.00
Extra Heavy - Foam Cell	<b>HOLD006DKF</b>	\$2272.00

**SUSPENSION KIT CONTENTS**

Shock Absorbers	Torsion Bars	Polyurethane Spring Bushes
Leaf Springs	U-Bolts	







RA  
2002 to 2006

# GM / Holden Rodeo

Product Description

Part No.

Qty  
Req

Retail  
ea Inc GST

## ACCESSORIES TO SUIT GM / HOLDEN RODEO

### STEEL WINCH BULL BARS

Commercial Deluxe

BBCD003

\$2244.00

• Can also be fitted to both 2WD and 4WD models.

### STEEL SIDE STEPS AND RAILS - FITS DUAL CAB MODELS ONLY

Side Steps

SS001

\$962.00

Side Steps and Rails

SSR006

\$1155.00

### UNDERBODY PROTECTION

Engine Bay and Transmission - *While Stocks Last*

IUP009K

\$563.00

### LOCKSAFE DRAWER SYSTEMS

Twin Drawers - 1300mm

ITD1300

\$1469.00

Single Drawer - 1300mm

ISD1300

\$891.00

### DIFF BREATHER KIT

Diff Breather Kit

IDIFFBRE

\$115.00



Product Description

Part No.

Qty  
Req

Retail  
ea Inc GST

**SUSPENSION TO SUIT GM / HOLDEN RODEO**

**FRONT SUSPENSION**

**SHOCK ABSORBER**

Nitro Gas - Performance **12643GR** 2 \$153.00

**TORSION BAR**

Up-rated Torsion Bars **HOLD005A** 1 \$416.00

• Minimum 60mm downward suspension travel required after adjustment

**REAR SUSPENSION**

**SHOCK ABSORBER**

Nitro Gas - Comfort **12636GRC** 2 \$153.00

Nitro Gas - Performance **12636GR** 2 \$153.00

Nitro Gas - Professional **12636GRP** 2 \$153.00

Foam Cell - Comfort **24636FEC** 2 \$222.00

Foam Cell - Performance **24636FE** 2 \$222.00

Foam Cell - Professional **24636FEP** 2 \$222.00

**LEAF SPRINGS**

Medium - Drivers Side 40mm 0 - 300kg **HOLD004BD/S** 1 \$375.00

Medium - Near Side 40mm 0 - 300kg **HOLD004BN/S** 1 \$375.00

Heavy - Drivers Side 40mm 300kg - GVM **HOLD004CD/S** 1 \$402.00

Heavy - Near Side 40mm 300kg - GVM **HOLD004CN/S** 1 \$402.00

**U-BOLTS**

U-Bolt Kit **415UBK** 2 \$42.00

**POLYURETHANE SPRING BUSHES**

Bush Kit **728UK** 1 \$84.00

**GREASABLE SHACKLES AND PINS**

Greasable Shackle **386-2** 2 \$56.00

Non-Greasable Pin **387-1** 2 \$28.00

**HELPER SPRINGS**

Load Plus Helper Springs **LP3** 1 \$157.00

Add-A-Leaf **ISL6010** 1 \$167.00

**SUSPENSION KIT**

Medium - Nitro Gas **HOLD004BKG2** \$1940.00

Heavy - Nitro Gas **HOLD004CKG2** \$1995.00

**SUSPENSION KIT CONTENTS**

Shock Absorbers

Torsion Bars

Polyurethane Spring Bushes

Leaf Springs

U-Bolts





KB - TF  
1983 to 1988

# GM / Holden Rodeo

Product Description

Part No.

Qty  
ReqRetail  
ea Inc GST

## SUSPENSION TO SUIT GM / HOLDEN RODEO

### FRONT SUSPENSION

#### SHOCK ABSORBER

Nitro Gas - Performance		<b>12087GR</b>	2	\$153.00
Foam Cell - Performance		<b>24087FE</b>	2	\$222.00

#### TORSION BAR

Uprated Torsion Bars	Suits 1983 - 1988	<b>MAZDA005</b>	1	\$416.00
----------------------	-------------------	-----------------	---	----------

• Minimum 60mm downward suspension travel required after adjustment

### REAR SUSPENSION

#### SHOCK ABSORBER

Nitro Gas - Comfort		<b>12636GRC</b>	2	\$153.00
Nitro Gas - Performance		<b>12636GR</b>	2	\$153.00
Nitro Gas - Professional		<b>12636GRP</b>	2	\$153.00
Foam Cell - Comfort		<b>24636FEC</b>	2	\$222.00
Foam Cell - Performance		<b>24636FE</b>	2	\$222.00
Foam Cell - Professional		<b>24636FEP</b>	2	\$222.00

#### LEAF SPRINGS

	Est. Lift	Additional Load			
Medium - Drivers Side	40mm	0 - 300kg	<b>HOLD004BD/S</b>	1	\$375.00
Medium - Near Side	40mm	0 - 300kg	<b>HOLD004BN/S</b>	1	\$375.00
Heavy - Drivers Side	40mm	300kg - GVM	<b>HOLD004CD/S</b>	1	\$402.00
Heavy - Near Side	40mm	300kg - GVM	<b>HOLD004CN/S</b>	1	\$402.00

#### U-BOLTS

U-Bolt Kit		<b>451UBK</b>	2	\$42.00
------------	--	---------------	---	---------

#### POLYURETHANE SPRING BUSHES

Bush Kit		<b>728UK</b>	1	\$84.00
----------	--	--------------	---	---------

#### GREASABLE SHACKLES AND PINS

Greasable Shackle		<b>791</b>	2	\$56.00
Greasable Pin		<b>792</b>	2	\$42.00

#### HELPER SPRINGS

Load Plus Helper Springs		<b>LP3</b>	1	\$157.00
Add-A-Leaf		<b>ISL6010</b>	1	\$167.00

### SUSPENSION KIT

Medium - Nitro Gas		<b>HOLD004BKG1</b>		\$1940.00
Medium - Foam Cell		<b>HOLD004BKF1</b>		\$2217.00
Heavy - Nitro Gas		<b>HOLD004CKG1</b>		\$1995.00
Heavy - Foam Cell		<b>HOLD004CKF1</b>		\$2272.00

### SUSPENSION KIT CONTENTS

Shock Absorbers	Torsion Bars	Polyurethane Spring Bushes
Leaf Springs	U-Bolts	



Product Description

Part No.

Qty  
Req

Retail  
ea Inc GST

## SUSPENSION TO SUIT GREAT WALL UTE

### FRONT SUSPENSION

#### SHOCK ABSORBER

Nitro Gas Strut - Performance			<b>12853GR</b>	2	\$222.00
Foam Cell Strut - Performance			<b>24853FE</b>	2	\$250.00
Foam Cell Pro Strut - Performance			<b>45853FE</b>	2	\$388.00

• Height adjustable with Ironman 4x4 Strut Trim Packers

#### COIL SPRINGS

	Est. Lift	Additional Load			
Standard	10mm	0 - 50kg	<b>TOY055A</b>	1	\$250.00
Light	50mm	0 - 50kg	<b>TOY055B</b>	1	\$250.00
Medium	50mm	50 - 110kg	<b>TOY055C</b>	1	\$250.00

#### STRUT MOUNTS

Steel Strut Top			<b>ISST083</b>	2	\$97.00
-----------------	--	--	----------------	---	---------

#### TRIM PACKERS

5mm Strut Trim Packer	Nitro Gas / Foam Cell	<b>HILFR05 / HILFR05F</b>	2	\$28.00
10mm Strut Trim Packer	Nitro Gas / Foam Cell	<b>HILFR10 / HILFR10F</b>	2	\$28.00
15mm Strut Trim Packer	Nitro Gas / Foam Cell	<b>HILFR15 / HILFR15F</b>	2	\$28.00

• ONLY Compatible with Ironman 4x4 Struts (except Pro), lift height subject to 2:1 motion ratio. Unnecessary fitment may lift vehicle too high

#### CONTROL ARMS

Pro-Forge Upper Control Arms			<b>UCA001FAS</b>	1	\$882.00
------------------------------	--	--	------------------	---	----------

### REAR SUSPENSION

#### SHOCK ABSORBER

Nitro Gas - Comfort			<b>12095GRC</b>	2	\$153.00
Nitro Gas - Performance			<b>12095GR</b>	2	\$153.00
Foam Cell - Comfort			<b>24095FEC</b>	2	\$222.00
Foam Cell - Performance			<b>24095FE</b>	2	\$222.00
Foam Cell - Professional			<b>24095FEP</b>	2	\$222.00
Foam Cell Pro - Comfort			<b>45095FEC</b>	2	\$305.00
Foam Cell Pro - Performance			<b>45095FE</b>	2	\$305.00
Foam Cell Pro - Professional			<b>45095FEP</b>	2	\$305.00

#### LEAF SPRINGS

	Est. Lift	Additional Load			
Light	40mm	0 - 200kg	<b>FOR002A</b>	2	\$375.00
Medium	50mm	0 - 300kg	<b>FOR002B</b>	2	\$375.00
Heavy	50mm	300kg - GVM	<b>FOR002C</b>	2	\$402.00

• Possible driveline vibration may occur due to increased ride height, use 1217K to reduce vibration to satisfactory level

#### U-BOLTS

U-Bolt Kit			<b>1107UBK</b>	2	\$42.00
------------	--	--	----------------	---	---------

#### POLYURETHANE SPRING BUSHES

Bush Kit			<b>1195UK</b>	1	\$167.00
----------	--	--	---------------	---	----------

#### DRIVELINE SPACERS

Centre Bearing Spacer Kit			<b>1217K</b>	1	\$28.00
---------------------------	--	--	--------------	---	---------

#### GREASABLE SHACKLES AND PINS

Greasable Shackle			<b>1147</b>	2	\$56.00
Non-Greasable Pin			<b>387-1</b>	2	\$28.00

#### HELPER SPRINGS

Load Plus Helper Springs			<b>LP3</b>	1	\$157.00
Add-A-Leaf			<b>ISL6010</b>	1	\$167.00

### SUSPENSION KIT

Light - Nitro Gas		<b>GWM002AKG</b>	\$2023.00
Light - Foam Cell		<b>GWM002AKF</b>	\$2217.00
Light - Foam Cell Pro		<b>GWM002AKP</b>	\$2660.00
Medium - Nitro Gas		<b>GWM002BKG</b>	\$2023.00
Medium - Foam Cell		<b>GWM002BKF</b>	\$2217.00
Medium - Foam Cell Pro		<b>GWM002BKP</b>	\$2660.00
Heavy - Nitro Gas		<b>GWM002CKG</b>	\$2078.00
Heavy - Foam Cell		<b>GWM002CKF</b>	\$2272.00
Heavy - Foam Cell Pro		<b>GWM002CKP</b>	\$2716.00

• Possible driveline vibration may occur due to increased ride height, use 1217K to reduce vibration to satisfactory level

\*Specify front Coil Springs when ordering

### SUSPENSION KIT CONTENTS

Shock Absorbers	Coil Springs	U-Bolts	Centre Bearing Spacer Kit
Strut Shock Absorbers	Leaf Springs	Polyurethane Spring Bushes	







Wagon 2.0L Petrol  
8/2017+

# Haval H9

Product Description

Part No.

Qty  
ReqRetail  
ea Inc GST

## SUSPENSION TO SUIT HAVAL H9

### FRONT SUSPENSION

#### SHOCK ABSORBER

Nitro Gas Strut - Performance			<b>12710GR</b>	2	\$222.00
Foam Cell Strut - Performance			<b>24710FE</b>	2	\$250.00

• Height adjustable with Ironman 4x4 Strut Trim Packers

#### COIL SPRINGS

	Est. Lift	Additional Load			
Medium	40mm	0 - 50kg	<b>TOY055C</b>	1	\$250.00
Heavy	40mm	50 - 110kg	<b>TOY065B</b>	1	\$250.00

#### STRUT MOUNTS

Steel Strut Top			<b>ISST001</b>	2	\$84.00
-----------------	--	--	----------------	---	---------

#### TRIM PACKERS

5mm Strut Trim Packer	Nitro Gas / Foam Cell	<b>HILFR05 / HILFR05F</b>	2	\$28.00
10mm Strut Trim Packer	Nitro Gas / Foam Cell	<b>HILFR10 / HILFR10F</b>	2	\$28.00
15mm Strut Trim Packer	Nitro Gas / Foam Cell	<b>HILFR15 / HILFR15F</b>	2	\$28.00

• ONLY Compatible with Ironman 4x4 Struts (except Pro), lift height subject to 2:1 motion ratio. Unnecessary fitment may lift vehicle too high

### REAR SUSPENSION

#### SHOCK ABSORBER

Nitro Gas - Performance			<b>12804GR</b>	2	\$153.00
Foam Cell - Performance			<b>24804FE</b>	2	\$222.00

#### COIL SPRINGS

	Est. Lift	Additional Load			
Medium	40mm	0 - 200kg	<b>TOY056A</b>	1	\$250.00
Heavy	40mm	200 - 400kg	<b>TOY056B</b>	1	\$250.00
Extra Heavy	40mm	400kg - GVM	<b>TOY056C</b>	1	\$250.00

### SUSPENSION KIT

Medium - Nitro Gas	<b>TOY056AKG</b>	\$1247.00
Medium - Foam Cell	<b>TOY056AKF</b>	\$1441.00
Heavy - Nitro Gas	<b>TOY056BKG</b>	\$1247.00
Heavy - Foam Cell	<b>TOY056BKF</b>	\$1441.00
Extra Heavy - Nitro Gas	<b>TOY056CKG</b>	\$1247.00
Extra Heavy - Foam Cell	<b>TOY056CKF</b>	\$1441.00

• Specify front Coil Springs when ordering

### SUSPENSION KIT CONTENTS

Shock Absorbers

Strut Shock Absorbers

Coil Springs

# Hyundai iLoad

2016+



Product Description

Part No.

Qty  
Req

Retail  
ea Inc GST

## ACCESSORIES TO SUIT HYUNDAI ILOAD

**SEAT COVER**

Canvas Comfort - Front Bucket and 3/4 Bench (Suits TQ3-V Series II)

**ICSCIOAD**

\$401.00





2001+

# Hyundai Terracan

Product Description

Part No.

Qty  
Req

Retail  
ea Inc GST

## SUSPENSION TO SUIT HYUNDAI TERRACAN

### FRONT SUSPENSION

#### SHOCK ABSORBER

Nitro Gas - Performance	<b>12087GR</b>	2	\$153.00
Foam Cell - Performance	<b>24087FE</b>	2	\$222.00

#### TORSION BAR

Uprated Torsion Bars	<b>HYUND004</b>	1	\$471.00
----------------------	-----------------	---	----------

• Minimum 60mm downward suspension travel required after adjustment

### REAR SUSPENSION

#### SHOCK ABSORBER

Nitro Gas - Comfort	<b>12637GRC</b>	2	\$153.00
Nitro Gas - Performance	<b>12637GR</b>	2	\$153.00

#### COIL SPRINGS

	Est. Lift	Additional Load		
Medium	40mm	0 - 300kg	<b>HYUND003B</b>	1

#### DIFF BREATHER EXTENDED

Breather Hose	<b>DHOSE350</b>	1	\$6.00
---------------	-----------------	---	--------

### SUSPENSION KIT

Medium - Nitro Gas	<b>HYUND003BKG</b>		\$1336.00
--------------------	--------------------	--	-----------

### SUSPENSION KIT CONTENTS

Shock Absorbers	Torsion Bar
Coil Springs	Extended Breather Hose



Product Description	DATE AVAILABLE	Part No.	Qty Req	Retail ea Inc GST
---------------------	----------------	----------	---------	-------------------

## ACCESSORIES TO SUIT ISUZU D-MAX

### STEEL WINCH BULL BARS

Commercial Deluxe		BBCD074		\$2284.00
Proguard No Loop		BBT074-NL		\$1888.00
Proguard Single Loop Kit		BB074-SL		\$336.00
Proguard Triple Loop Kit		BB074-TL		\$404.00
Driving Light Patch Loom - Factory LED Headlight models only		IPL074		\$31.00
Load Resistor Kit with Mounting Brackets for Indicator / Parker Replacement		LR12V21W		\$56.00

• Winch with Steel Cable and Roller Fairlead is not suitable - Use Winch with Synthetic Rope and Alloy Hawse only

### STEEL SIDE STEPS AND RAILS

Side Steps		SS074		\$962.00
Side Rails		SS074 RAIL		\$317.00
Side Steps and Rails		SSR074		\$1155.00

### TOWING

Rear Protection Towbar	Q4 2021	RTB074		\$1328.00
Towbar Wiring Loom - Plug and Play		ITBL074		\$445.00

### RECOVERY POINTS - IRONMAN 4X4 BULL BAR ONLY

Recovery Points (Pair)		IRP074		\$217.00
------------------------	--	--------	--	----------

### SNORKEL

D-Max 8/2019+	Q4 2021	ISNORKEL074		\$418.00
---------------	---------	-------------	--	----------

### PREMIUM UNDERBODY PROTECTION

Engine Bay and Transmission - Electric Steering Model	Q4 2021	UBP074S		\$712.00
Engine Bay and Transmission - Non-Electric Steering Model		UBP074		\$712.00

### LOCKSAFE DRAWER SYSTEMS

Twin Drawers - 1300mm		ITD1300		\$1469.00
Single Drawer - 1300mm		ISD1300		\$891.00
Wing Kit - 1300mm*	Q4 2021	ITDW074		\$351.00

\*Designed to suit factory tubs, will not suit ute liner without modification

### CANOPY - ABS PLASTIC (SIDE LIFT UP WINDOWS AND CENTRAL LOCKING REAR DOOR) - FITS 4X4 AND 4X2 DUAL CAB MODELS

Pre-Primed		CANOPY022-P		\$3238.00*
Marble White (527)		CANOPY022-W		\$3856.00
ABS Canopy Rack Feet		IRRFETABS14		\$274.00

• See Page 37 and 38 for 1.4m Roof Rack options and pricing.

\* Pre-primed canopies, plus colour coding.

### CANOPY - PINNACLE 2 FIBREGLASS (SIDE LIFT UP WINDOWS AND CENTRAL LOCKING REAR DOOR) - FITS 4X4 AND 4X2 DUAL CAB MODELS

Pre-Primed		ICANOPY074-P		\$2899.00*
Basalt Black (569)		ICANOPY074-B		\$3399.00
Galena Grey (563)		ICANOPY074-GG		\$3399.00
Obsidian Grey (554)		ICANOPY074-OG		\$3399.00
Mercury Silver (568)		ICANOPY074-S		\$3399.00
Marble White (527)		ICANOPY074-W		\$3399.00

### SLIDE-AWAY ROLL UP HARD TONNEAU COVER

Electric with Remote Control		ISLIDEAWAY074-E		\$2599.00
------------------------------	--	-----------------	--	-----------

### SEAT COVER

Canvas Comfort - Front		ICSC074F		\$401.00
Canvas Comfort - Rear		ICSC074R		\$401.00

### DIFF BREATHER KIT

Diff Breather Kit		IDIFFBRE		\$115.00
-------------------	--	----------	--	----------



8/2019+

Product Description

Part No.

Qty  
ReqRetail  
ea Inc GST

## SUSPENSION TO SUIT ISUZU D-MAX

## FRONT SUSPENSION

## SHOCK ABSORBER

Nitro Gas Strut - Performance			<b>12845GR</b>	2	\$222.00
Foam Cell Strut - Performance			<b>24845FE</b>	2	\$250.00
Foam Cell Pro Strut - Performance			<b>45845FE</b>	2	\$388.00

- Height adjustable with Ironman 4x4 Strut Trim Packers

## COIL SPRINGS

	Est. Lift	Additional Load			
Standard	0mm	0 - 50kg	<b>HOLD020S</b>	1	\$250.00
Light	30mm	0 - 50kg	<b>HOLD020A</b>	1	\$250.00
Medium	40mm	0 - 50kg	<b>HOLD020B</b>	1	\$250.00
Heavy	40mm	50 - 110kg	<b>HOLD020C</b>	1	\$250.00

## STRUT MOUNTS

Steel Strut Top			<b>ISST017</b>	2	\$84.00
-----------------	--	--	----------------	---	---------

## TRIM PACKERS

5mm Strut Trim Packer	Nitro Gas / Foam Cell	<b>HILFR05 / HILFR05F</b>	2	\$28.00
10mm Strut Trim Packer	Nitro Gas / Foam Cell	<b>HILFR10 / HILFR10F</b>	2	\$28.00
15mm Strut Trim Packer	Nitro Gas / Foam Cell	<b>HILFR15 / HILFR15F</b>	2	\$28.00

- ONLY Compatible with Ironman 4x4 Struts (except Pro), lift height subject to 2:1 motion ratio. Unnecessary fitment may lift vehicle too high

## CONTROL ARMS

Pro-Forge Upper Control Arms			<b>UCA074FA</b>	1	\$882.00
------------------------------	--	--	-----------------	---	----------

## REAR SUSPENSION

## SHOCK ABSORBER

Nitro Gas - Comfort			<b>12698GRC</b>	2	\$153.00
Nitro Gas - Performance			<b>12698GR</b>	2	\$153.00
Nitro Gas - Professional			<b>12698GRP</b>	2	\$153.00
Foam Cell - Comfort			<b>24698FEC</b>	2	\$222.00
Foam Cell - Performance			<b>24698FE</b>	2	\$222.00
Foam Cell - Professional			<b>24698FEP</b>	2	\$222.00
Foam Cell Pro - Comfort			<b>45698FEC</b>	2	\$305.00
Foam Cell Pro - Performance			<b>45698FE</b>	2	\$305.00
Foam Cell Pro - Professional			<b>45698FEP</b>	2	\$305.00

## LEAF SPRINGS

	Est. Lift	Additional Load			
Light	30mm	0 - 200kg	<b>HOLD021A</b>	2	\$402.00
Medium	45mm	0 - 300kg	<b>HOLD021B</b>	2	\$402.00
Heavy	45mm	300kg - 600kg	<b>HOLD021C</b>	2	\$416.00
Extra Heavy	45mm	600kg - GVM	<b>HOLD021D</b>	2	\$416.00

## U-BOLTS

U-Bolt Kit			<b>437UBKL</b>	2	\$42.00
U-Bolt Kit	Suits HOLD021D		<b>678UBK</b>	2	\$42.00

## POLYURETHANE SPRING BUSHES

Bush Kit			<b>770UK</b>	1	\$167.00
----------	--	--	--------------	---	----------

## SPACER KIT

Brake Hose Relocation Kit			<b>1152K</b>	1	\$14.00
---------------------------	--	--	--------------	---	---------

## GREASABLE SHACKLES AND PINS

Greasable Shackle			<b>1156</b>	2	\$56.00
Non-Greasable Pin			<b>387-1</b>	2	\$28.00

## HELPER SPRINGS

Add-A-Leaf			<b>ISL6010</b>	1	\$167.00
------------	--	--	----------------	---	----------



LISTING  
CONTINUED  
OVER THE  
PAGE



**Product Description**

**Part No.**

**Qty  
Req**

**Retail  
ea Inc GST**

**SUSPENSION KIT**

Light - Nitro Gas	<b>HOLD021AKG3</b>	\$2064.00
Light - Foam Cell	<b>HOLD021AKF3</b>	\$2258.00
Light - Foam Cell Pro	<b>HOLD021AKP3</b>	\$2702.00
Medium - Nitro Gas	<b>HOLD021BKG3</b>	\$2064.00
Medium - Foam Cell	<b>HOLD021BKF3</b>	\$2258.00
Medium - Foam Cell Pro	<b>HOLD021BKP3</b>	\$2702.00
Heavy - Nitro Gas	<b>HOLD021CKG3</b>	\$2092.00
Heavy - Foam Cell	<b>HOLD021CKF3</b>	\$2286.00
Heavy - Foam Cell Pro	<b>HOLD021CKP3</b>	\$2729.00
Extra Heavy - Nitro Gas	<b>HOLD021DKG3</b>	\$2092.00
Extra Heavy - Foam Cell	<b>HOLD021DKF3</b>	\$2286.00
Extra Heavy - Foam Cell Pro	<b>HOLD021DKP3</b>	\$2729.00

• Specify front Coil Springs when ordering

**SUSPENSION KIT CONTENTS**

Shock Absorbers  
Strut Shock Absorbers

Coil Springs  
Leaf Springs

Polyurethane Spring Bushes  
U-Bolts

Brake Hose Relocation Kit



**OPTIONS AVAILABLE FOR THIS VEHICLE - SEE PAGE 381**

2/2017 to 7/2019

Product Description

Part No.

Qty  
ReqRetail  
ea Inc GST

## ACCESSORIES TO SUIT ISUZU D-MAX

**STEEL WINCH BULL BARS (WILL NOT FIT NARROW BODY)**

Commercial	BBC058	\$1648.00
Commercial Deluxe	BBCD058	\$2244.00
Protector	BBT058	\$2271.00
Proguard No Loop	BBT058-NL	\$1855.00
Proguard Single Loop Kit	BB058-SL	\$336.00
Proguard Triple Loop Kit	BB058-TL	\$404.00
Driving Light Patch Loom - Factory LED Headlight models only	IPL058	\$31.00

- Can also be fitted to both 2WD and 4WD models.

**STEEL SIDE STEPS AND RAILS - FITS DUAL, SPACE AND SINGLE CAB MODELS ONLY**

Side Steps	SS057	\$962.00
Side Rails	SS057 RAIL	\$317.00
Side Steps and Rails	SSR057	\$1155.00

**TOWING**

Class 4 Towbar - Compatible with Factory Rear Bumper	TB041	\$581.00
Rear Protection Towbar - Full Rear Bumper Replacement	RTB041	\$1328.00
Rear Protection Towbar Plates (Pair)	RTBPLATE002	\$146.00
Towbar Wiring Loom - Plug and Play	ITBL041	\$155.00

**RECOVERY POINTS - IRONMAN 4X4 BULL BAR ONLY**

Recovery Points - 5000kg rating (Pair)	IRP058	\$309.00
--	--------	----------

**SNORKEL**

3.0L Turbo Diesel	ISNORKEL041	\$418.00
-------------------	-------------	----------

**LONG RANGE FUEL TANK**

145L* Diesel only - Fits Dual Cab Automatic Transmission only	TANK057	\$1129.00
---	---------	-----------

- \* Usable volume may differ to the stated tank capacity

**EXHAUST SYSTEM**

3" Exhaust Upgrade 3.0L - DPF Back - <i>While Stocks Last</i>	IEX058	\$770.00
---	--------	----------

**PREMIUM UNDERBODY PROTECTION**

Engine Bay and Transmission	UBP041	\$748.00
-----------------------------	--------	----------

**LOCKSAFE DRAWER SYSTEMS**

Twin Drawers - 1300mm	ITD1300	\$1469.00
Single Drawer - 1300mm	ISD1300	\$891.00
Wing Kit - 1300mm*	ITDW038	\$351.00

- \* Designed to suit factory tubs, will not suit ute liner without modification

**CANOPY - ABS PLASTIC (SIDE LIFT UP WINDOWS AND CENTRAL LOCKING REAR DOOR) - FITS 4X4 AND 4X2 DUAL CAB MODELS**

Pre-Primed	CANOPY020-P	\$3238.00*
Blue (565)	CANOPY020-B	\$3856.00
Graphite (563)	CANOPY020-GG	\$3856.00
Cosmic Black (523)	CANOPY020-CB	\$3856.00
ABS Canopy Rack Feet	IRRFEEABS14	\$274.00

- See Page 37 and 38 for 1.4m Roof Rack options and pricing.

- \* Pre-primed canopies, plus colour coding.

**SEAT COVER**

Canvas Comfort - Front	ICSC040F	\$401.00
Canvas Comfort - Rear	ICSC040R	\$401.00

**DIFF BREATHER KIT**

Diff Breather Kit	IDIFFBRE	\$115.00
-------------------	----------	----------



LISTING  
CONTINUED  
OVER THE  
PAGE



Product Description

Part No.

Qty  
Req

Retail  
ea Inc GST

## SUSPENSION TO SUIT ISUZU D-MAX

### FRONT SUSPENSION

#### SHOCK ABSORBER

Nitro Gas Strut - Performance			<b>12745GR</b>	2	\$222.00
Foam Cell Strut - Performance			<b>24745FE</b>	2	\$250.00
Foam Cell Pro Strut - Performance			<b>45745FE</b>	2	\$388.00

• Height adjustable with Ironman 4x4 Strut Trim Packers

#### COIL SPRINGS

	Est. Lift	Additional Load			
Medium	40mm	0 - 50kg	<b>HOLD020A</b>	1	\$250.00
Heavy	40mm	50 - 110kg	<b>HOLD020B</b>	1	\$250.00

#### STRUT MOUNTS

Steel Strut Top			<b>ISST017</b>	2	\$84.00
-----------------	--	--	----------------	---	---------

#### TRIM PACKERS

5mm Strut Trim Packer	Nitro Gas / Foam Cell	<b>HILFR05 / HILFR05F</b>	2	\$28.00
10mm Strut Trim Packer	Nitro Gas / Foam Cell	<b>HILFR10 / HILFR10F</b>	2	\$28.00
15mm Strut Trim Packer	Nitro Gas / Foam Cell	<b>HILFR15 / HILFR15F</b>	2	\$28.00

• ONLY Compatible with Ironman 4x4 Struts (except Pro), lift height subject to 2:1 motion ratio. Unnecessary fitment may lift vehicle too high

#### CONTROL ARMS

Pro-Forge Upper Control Arms			<b>UCA041FAS</b>	1	\$882.00
------------------------------	--	--	------------------	---	----------

### REAR SUSPENSION

#### SHOCK ABSORBER

Nitro Gas - Comfort			<b>12636GRC</b>	2	\$153.00
Nitro Gas - Performance			<b>12636GR</b>	2	\$153.00
Nitro Gas - Professional			<b>12636GRP</b>	2	\$153.00
Foam Cell - Comfort			<b>24636FEC</b>	2	\$222.00
Foam Cell - Performance			<b>24636FE</b>	2	\$222.00
Foam Cell - Professional			<b>24636FEP</b>	2	\$222.00
Foam Cell Pro - Comfort			<b>45636FEC</b>	2	\$305.00
Foam Cell Pro - Performance			<b>45636FE</b>	2	\$305.00
Foam Cell Pro - Professional			<b>45636FEP</b>	2	\$305.00

#### LEAF SPRINGS

	Est. Lift	Additional Load			
Light	30mm	0 - 200kg	<b>HOLD021A</b>	2	\$402.00
Medium	45mm	0 - 300kg	<b>HOLD021B</b>	2	\$402.00
Heavy	45mm	300kg - 600kg	<b>HOLD021C</b>	2	\$416.00
Extra Heavy	45mm	600kg - GVM	<b>HOLD021D</b>	2	\$416.00

#### U-BOLTS

U-Bolt Kit			<b>437UBKL</b>	2	\$42.00
U-Bolt Kit	Suits HOLD021D		<b>678UBK</b>	2	\$42.00

#### POLYURETHANE SPRING BUSHES

Bush Kit			<b>770UK</b>	1	\$167.00
----------	--	--	--------------	---	----------

#### SPACER KIT

Brake Hose Relocation Kit			<b>1152K</b>	1	\$14.00
Tailshaft Spacer			<b>ITSS021</b>	1	\$84.00

#### GREASABLE SHACKLES AND PINS

Greasable Shackle			<b>1148</b>	2	\$56.00
Non-Greasable Pin			<b>387-1</b>	2	\$28.00

#### HELPER SPRINGS

Add-A-Leaf			<b>ISL6010</b>	1	\$167.00
------------	--	--	----------------	---	----------





2016 to 7/2019

# Isuzu D-Max

Product Description

Part No.

Qty  
Req

Retail  
ea Inc GST

## SUSPENSION KIT

Light - Nitro Gas	HOLD021AKG1	\$2064.00
Light - Foam Cell	HOLD021AKF1	\$2258.00
Light - Foam Cell Pro	HOLD021AKP1	\$2702.00
Medium - Nitro Gas	HOLD021BKG1	\$2064.00
Medium - Foam Cell	HOLD021BKF1	\$2258.00
Medium - Foam Cell Pro	HOLD021BKP1	\$2702.00
Heavy - Nitro Gas	HOLD021CKG1	\$2092.00
Heavy - Foam Cell	HOLD021CKF1	\$2286.00
Heavy - Foam Cell Pro	HOLD021CKP1	\$2729.00
Extra Heavy - Nitro Gas	HOLD021DKG1	\$2092.00
Extra Heavy - Foam Cell	HOLD021DKF1	\$2286.00
Extra Heavy - Foam Cell Pro	HOLD021DKP1	\$2729.00

• Specify front Coil Springs when ordering

## SUSPENSION KIT CONTENTS

Shock Absorbers	Coil Springs	U-Bolts	Brake Hose Relocation Kit
Strut Shock Absorbers	Leaf Springs	Polyurethane Spring Bushes	



OPTIONS AVAILABLE FOR THIS VEHICLE - SEE PAGE 382



Product Description

Part No.

Qty  
Req

Retail  
ea Inc GST

## ACCESSORIES TO SUIT ISUZU D-MAX

### STEEL WINCH BULL BARS - WILL NOT FIT NARROW BODY

Commercial	BBC041	\$1648.00
Commercial Deluxe	BBCD041	\$2244.00
Protector - <i>While Stocks Last</i>	BBT041	\$2271.00
Driving Light Patch Loom - Factory LED Headlight models only • <i>Can also be fitted to both 2WD and 4WD models.</i>	IPL058	\$31.00

### STEEL SIDE STEPS AND RAILS

Side Steps	SS057	\$962.00
Side Rails	SS057 RAIL	\$317.00
Side Steps and Rails	SSR057	\$1155.00

### TOWING

Class 4 Towbar - Compatible with Factory Rear Bumper	TB041	\$581.00
Rear Protection Towbar - Full Rear Bumper Replacement	RTB041	\$1328.00
Rear Protection Towbar Plates (Pair)	RTBPLATE002	\$146.00
Towbar Wiring Loom - Plug and Play	ITBL041	\$155.00

### RECOVERY POINTS - IRONMAN 4X4 BULL BAR ONLY

Recovery Points - 5000kg Rating (Pair)	IRP058	\$309.00
--	--------	----------

### SNORKEL

3.0L Turbo Diesel	ISNORKEL041	\$418.00
-------------------	-------------	----------

### LONG RANGE FUEL TANK

145L* Diesel only - Fits Dual Cab only * Usable volume may differ to the stated tank capacity	TANK057	\$1129.00
--	---------	-----------

### PREMIUM UNDERBODY PROTECTION

Engine Bay and Transmission	UBP041	\$748.00
-----------------------------	--------	----------

### LOCKSAFE DRAWER SYSTEMS

Twin Drawers - 1300mm	ITD1300	\$1469.00
Single Drawer - 1300mm	ISD1300	\$891.00
Wing Kit - 1300mm*	ITDW038	\$351.00

\*Designed to suit factory tubs, will not suit ute liner without modification.

### CANOPY ABS PLASTIC (SIDE LIFT UP WINDOWS) - FITS 4X4 AND 4X2 DUAL CAB MODELS

Pre-Primed	CANOPY020-P	\$3238.00*
ABS Canopy Rack Feet • See Page 37 and 38 for 1.4m Roof Rack options and pricing. * Pre-primed canopies, plus colour coding.	IRRFEETABS14	\$274.00

### SEAT COVER

Canvas Comfort - Front	ICSC040F	\$401.00
Canvas Comfort - Rear	ICSC040R	\$401.00

### DIFF BREATHER KIT

Diff Breather Kit	IDIFFBRE	\$115.00
-------------------	----------	----------



6/2012 to 1/2017

SUSPENSION TO SUIT

# Isuzu D-Max

Product Description

Part No.

Qty  
Req

Retail  
ea Inc GST

## SUSPENSION TO SUIT ISUZU D-MAX

### FRONT SUSPENSION

#### SHOCK ABSORBER

Nitro Gas Strut - Performance		<b>12745GR</b>	2	\$222.00
Foam Cell Strut - Performance		<b>24745FE</b>	2	\$250.00
Foam Cell Pro Strut - Performance		<b>45745FE</b>	2	\$388.00

• Height adjustable with Ironman 4x4 Strut Trim Packers

#### COIL SPRINGS

	Est. Lift	Additional Load			
Standard	0mm	0 - 50kg	<b>HOLD020S</b>	1	\$250.00
Light	30mm	0 - 50kg	<b>HOLD020A</b>	1	\$250.00
Medium	40mm	0 - 50kg	<b>HOLD020B</b>	1	\$250.00
Heavy	40mm	50 - 110kg	<b>HOLD020C</b>	1	\$250.00

#### STRUT MOUNTS

Steel Strut Top		<b>ISST017</b>	2	\$84.00
-----------------	--	----------------	---	---------

#### TRIM PACKERS

5mm Strut Trim Packer	Nitro Gas / Foam Cell	<b>HILFR05 / HILFR05F</b>	2	\$28.00
10mm Strut Trim Packer	Nitro Gas / Foam Cell	<b>HILFR10 / HILFR10F</b>	2	\$28.00
15mm Strut Trim Packer	Nitro Gas / Foam Cell	<b>HILFR15 / HILFR15F</b>	2	\$28.00

• ONLY Compatible with Ironman 4x4 Struts (except Pro), lift height subject to 2:1 motion ratio. Unnecessary fitment may lift vehicle too high

#### CONTROL ARMS

Pro-Forge Upper Control Arms		<b>UCA041FAS</b>	1	\$882.00
------------------------------	--	------------------	---	----------

### REAR SUSPENSION

#### SHOCK ABSORBER

Nitro Gas - Comfort		<b>12636GRC</b>	2	\$153.00
Nitro Gas - Performance		<b>12636GR</b>	2	\$153.00
Nitro Gas - Professional		<b>12636GRP</b>	2	\$153.00
Foam Cell - Comfort		<b>24636FEC</b>	2	\$222.00
Foam Cell - Performance		<b>24636FE</b>	2	\$222.00
Foam Cell - Professional		<b>24636FEP</b>	2	\$222.00
Foam Cell Pro - Comfort		<b>45636FEC</b>	2	\$305.00
Foam Cell Pro - Performance		<b>45636FE</b>	2	\$305.00
Foam Cell Pro - Professional		<b>45636FEP</b>	2	\$305.00

#### LEAF SPRINGS

	Est. Lift	Additional Load			
Light	30mm	0 - 200kg	<b>HOLD021A</b>	2	\$402.00
Medium	45mm	0 - 300kg	<b>HOLD021B</b>	2	\$402.00
Heavy	45mm	300kg - 600kg	<b>HOLD021C</b>	2	\$416.00
Extra Heavy	45mm	600kg - GVM	<b>HOLD021D</b>	2	\$416.00

#### U-BOLTS

U-Bolt Kit		<b>437UBKL</b>	2	\$42.00
U-Bolt Kit	Suits HOLD021D	<b>678UBK</b>	2	\$42.00

#### POLYURETHANE SPRING BUSHES

Bush Kit		<b>770UK</b>	1	\$167.00
----------	--	--------------	---	----------

#### SPACER KIT

Brake Hose Relocation Kit		<b>1152K</b>	1	\$14.00
Tailshaft Spacer		<b>ITSS021</b>	1	\$84.00

#### GREASABLE SHACKLES AND PINS

Greasable Shackle		<b>1148</b>	2	\$56.00
Non-Greasable Pin		<b>387-1</b>	2	\$28.00

#### HELPER SPRINGS

Add-A-Leaf		<b>ISL6010</b>	1	\$167.00
------------	--	----------------	---	----------

LISTING  
CONTINUED  
OVER THE  
PAGE



# Isuzu D-Max

6/2012 to 1/2017



Product Description

Part No.

Qty  
Req

Retail  
ea Inc GST

## SUSPENSION KIT

Light - Nitro Gas	<b>HOLD021AKG</b>	\$2064.00
Light - Foam Cell	<b>HOLD021AKF</b>	\$2258.00
Light - Foam Cell Pro	<b>HOLD021AKP</b>	\$2702.00
Medium - Nitro Gas	<b>HOLD021BKG</b>	\$2064.00
Medium - Foam Cell	<b>HOLD021BKF</b>	\$2258.00
Medium - Foam Cell Pro	<b>HOLD021BKP</b>	\$2702.00
Heavy - Nitro Gas	<b>HOLD021CKG</b>	\$2092.00
Heavy - Foam Cell	<b>HOLD021CKF</b>	\$2286.00
Heavy - Foam Cell Pro	<b>HOLD021CKP</b>	\$2729.00
Extra Heavy - Nitro Gas	<b>HOLD021DKG</b>	\$2092.00
Extra Heavy - Foam Cell	<b>HOLD021DKF</b>	\$2286.00
Extra Heavy - Foam Cell Pro	<b>HOLD021DKP</b>	\$2729.00

• Specify front Coil Springs when ordering

## SUSPENSION KIT CONTENTS

Shock Absorbers	Coil Springs	U-Bolts	Brake Hose Relocation Kit
Strut Shock Absorbers	Leaf Springs	Polyurethane Spring Bushes	



**OPTIONS AVAILABLE FOR THIS VEHICLE - SEE PAGE 382**





Low Ride 2WD  
2012+

## Product Description

## Part No.

Qty  
ReqRetail  
ea Inc GST

## SUSPENSION TO SUIT ISUZU D-MAX

### FRONT SUSPENSION

#### SHOCK ABSORBER

Nitro Gas Strut - Performance **12797GR** 2 \$222.00

• Height adjustable with Ironman 4x4 Strut Trim Packers

#### COIL SPRINGS

	Est. Lift	Additional Load			
Medium	35mm	0 - 50kg	<b>TOY038B</b>	1	\$250.00
Heavy	35mm	50 - 110kg	<b>TOY038C</b>	1	\$250.00

#### TRIM PACKERS

5mm Strut Trim Packer	Nitro Gas / Foam Cell	<b>HILFR05 / HILFR05F</b>	2	\$28.00
10mm Strut Trim Packer	Nitro Gas / Foam Cell	<b>HILFR10 / HILFR10F</b>	2	\$28.00
15mm Strut Trim Packer	Nitro Gas / Foam Cell	<b>HILFR15 / HILFR15F</b>	2	\$28.00

• ONLY Compatible with Ironman 4x4 Struts (except Pro), lift height subject to 2:1 motion ratio. Unnecessary fitment may lift vehicle too high

### REAR SUSPENSION

#### SHOCK ABSORBER

Nitro Gas - Comfort	<b>12636GRC</b>	2	\$153.00
Nitro Gas - Performance	<b>12636GR</b>	2	\$153.00
Nitro Gas - Professional	<b>12636GRP</b>	2	\$153.00
Foam Cell - Comfort	<b>24636FEC</b>	2	\$222.00
Foam Cell - Performance	<b>24636FE</b>	2	\$222.00
Foam Cell - Professional	<b>24636FEP</b>	2	\$222.00

#### LEAF SPRINGS

	Est. Lift	Additional Load			
Medium	45mm	0 - 300kg	<b>HOLD023B</b>	2	\$375.00
Heavy	45mm	300kg - 600kg	<b>HOLD023C</b>	2	\$402.00

#### U-BOLTS

U-Bolt Kit **417UBK** 2 \$42.00

#### POLYURETHANE SPRING BUSHES

Bush Kit **728UK** 1 \$84.00

#### GREASABLE SHACKLES AND PINS

Greasable Shackle **386-2** 2 \$56.00

#### HELPER SPRINGS

Add-A-Leaf **ISL6010** 1 \$167.00

### SUSPENSION KIT

Medium - Nitro Gas **HOLD023BKG** \$1912.00

Heavy - Nitro Gas **HOLD023CKG** \$1967.00

• Specify front Coil Springs when ordering

### SUSPENSION KIT CONTENTS

Shock Absorbers

Coil Springs

Polyurethane Spring Bushes

Leaf Springs

U-Bolts

Strut Shock Absorbers



Product Description

Part No.

Qty  
Req

Retail  
ea Inc GST

## ACCESSORIES TO SUIT ISUZU D-MAX

### STEEL WINCH BULL BARS

Commercial Deluxe

**BBCD020**

\$2244.00

• Can also be fitted to both 2WD and 4WD models.

### STEEL SIDE STEPS AND RAILS - FITS DUAL CAB MODELS ONLY

Side Steps

**SS001**

\$962.00

Side Steps and Rails

**SSR006**

\$1155.00

### SNORKEL

D-MAX 2009+ (Does not fit 4x2 SX model)

**ISNORKEL022**

\$418.00

### UNDERBODY PROTECTION

Engine Bay and Transmission - *While Stocks Last*

**IUP009K**

\$563.00

### LOCKSAFE DRAWER SYSTEMS

Twin Drawers - 1300mm

**ITD1300**

\$1469.00

Single Drawer - 1300mm

**ISD1300**

\$891.00

### DIFF BREATHER KIT

Diff Breather Kit

**IDIFFBRE**

\$115.00

## Isuzu D-Max

2003 to 2012

Product Description

Part No.

Qty  
ReqRetail  
ea Inc GST

## SUSPENSION TO SUIT ISUZU D-MAX

## FRONT SUSPENSION

## SHOCK ABSORBER

Nitro Gas - Performance	12667GR	2	\$153.00
Foam Cell - Performance	24667FE	2	\$222.00

## TORSION BAR

Uprated Torsion Bars	HOLD010	1	\$416.00
----------------------	---------	---	----------

• Minimum 60mm downward suspension travel required after adjustment

## REAR SUSPENSION

## SHOCK ABSORBER

Nitro Gas - Comfort	12636GRC	2	\$153.00
Nitro Gas - Performance	12636GR	2	\$153.00
Nitro Gas - Professional	12636GRP	2	\$153.00
Foam Cell - Comfort	24636FEC	2	\$222.00
Foam Cell - Performance	24636FE	2	\$222.00
Foam Cell - Professional	24636FEP	2	\$222.00

## LEAF SPRINGS

	Est. Lift	Additional Load			
Medium	40mm	0 - 300kg	HOLD006B	2	\$375.00
Heavy	40mm	300kg - 600kg	HOLD006C	2	\$402.00
Extra Heavy	40mm	600 kg - GVM	HOLD006D	2	\$402.00

## U-BOLTS

U-Bolt Kit	417UBK	2	\$42.00
------------	--------	---	---------

## POLYURETHANE SPRING BUSHES

Bush Kit	728TUK	1	\$84.00
----------	--------	---	---------

## GREASABLE SHACKLES AND PINS

Greasable Shackle	386-2	2	\$56.00
Non-Greasable Pin	387-1	2	\$28.00

## HELPER SPRINGS

Add-A-Leaf	ISL6010	1	\$167.00
------------	---------	---	----------

• Load Plus not suitable for Rodeo / Colorado / D-Max with OEM springs due to interleaf liners

## SUSPENSION KIT

Medium - Nitro Gas	HOLD006BKG	\$1940.00
Medium - Foam Cell	HOLD006BKF	\$2217.00
Heavy - Nitro Gas	HOLD006CKG	\$1995.00
Heavy - Foam Cell	HOLD006CKF	\$2272.00
Extra Heavy - Nitro Gas	HOLD006DKG	\$1995.00
Extra Heavy - Foam Cell	HOLD006DKF	\$2272.00

## SUSPENSION KIT CONTENTS

Shock Absorbers

Torsion Bars

Polyurethane Spring Bushes

Leaf Springs

U-Bolts



Product Description

Part No.

Qty  
Req

Retail  
ea Inc GST

## ACCESSORIES TO SUIT ISUZU MU-X

### STEEL WINCH BULL BARS

Commercial Deluxe - (2014 to 2/2017)	BBCD049	\$2244.00
Commercial Deluxe - (3/2017+)	BBCD061	\$2244.00
Protector - (2014 to 2/2017) - <i>While Stocks Last</i>	BBT049	\$1995.00
Proguard No Loop - (3/2017+)	BBT061-NL	\$1855.00
Proguard Single Loop Kit	BB061-SL	\$336.00
Proguard Triple Loop Kit - (3/2017+)	BB061-TL	\$404.00
Driving Light Patch Loom - Factory LED Headlight models only	IPL058	\$31.00

### STEEL SIDE STEPS AND RAILS

Side Steps	SS044	\$962.00
Side Rails	SS044 RAIL	\$317.00
Side Steps and Rails	SSR044	\$1155.00

### RECOVERY POINTS - IRONMAN 4X4 BULL BAR ONLY

Recovery Points - 5000kg Rating (Pair)	IRP058	\$309.00
--	--------	----------

### SNORKEL

3.0L Turbo Diesel	ISNORKEL041	\$418.00
-------------------	-------------	----------

### PREMIUM UNDERBODY PROTECTION

Engine Bay and Transmission	UBP041	\$748.00
-----------------------------	--------	----------

### STEEL ROOF RACKS

Cage Style - 1.8m x 1.25m	IRRCAGE18	\$815.00
Rooftop Tent Compatible - 1.8m x 1.25m	IRRTENT18	\$777.00
Trade Style - 1.8m x 1.25m (Open end)	IRRTRADE18	\$777.00

### ALLOY ROOF RACKS

Cage Style - 1.8m x 1.25m	IRRCAGE18-ALLOY	\$1149.00
Trade Style - 1.8m x 1.25m (Open end)	IRRTRADE18-ALLOY	\$1132.00
Flat Rack - 1.8m x 1.25m	IRRFLAT18-ALLOY	\$1116.00

### ROOF RACK - MOUNTING KITS

MU-X Mount to suit LS-T model only	IRRFEETMUX	\$218.00
------------------------------------	------------	----------

• Will only fit vehicles with factory fitted roof bars.

### SEAT COVER

Canvas Comfort - Front	ICSC040F	\$401.00
Canvas Comfort - Rear	ICSC049R	\$401.00

### DIFF BREATHER KIT

Diff Breather Kit	IDIFFBRE	\$115.00
-------------------	----------	----------



2013 to 2021

Product Description

Part No.

Qty  
ReqRetail  
ea Inc GST

## SUSPENSION TO SUIT ISUZU MU-X

## FRONT SUSPENSION

## SHOCK ABSORBER

Nitro Gas Strut - Performance			<b>12745GR</b>	2	\$222.00
Foam Cell Strut - Performance			<b>24745FE</b>	2	\$250.00
Foam Cell Pro Strut - Performance			<b>45745FE</b>	2	\$388.00

- Height adjustable with Ironman 4x4 Strut Trim Packers

## COIL SPRINGS

	Est. Lift	Additional Load			
Standard	0mm	0 - 50kg	<b>HOLD020S</b>	1	\$250.00
Light	30mm	0 - 50kg	<b>HOLD020A</b>	1	\$250.00
Medium	40mm	0 - 50kg	<b>HOLD020B</b>	1	\$250.00
Heavy	40mm	50 - 110kg	<b>HOLD020C</b>	1	\$250.00

## STRUT MOUNTS

Steel Strut Top			<b>ISST017</b>	2	\$84.00
-----------------	--	--	----------------	---	---------

## TRIM PACKERS

5mm Strut Trim Packer	Nitro Gas / Foam Cell	<b>HILFR05 / HILFR05F</b>	2	\$28.00
10mm Strut Trim Packer	Nitro Gas / Foam Cell	<b>HILFR10 / HILFR10F</b>	2	\$28.00
15mm Strut Trim Packer	Nitro Gas / Foam Cell	<b>HILFR15 / HILFR15F</b>	2	\$28.00

- ONLY Compatible with Ironman 4x4 Struts (except Pro), lift height subject to 2:1 motion ratio. Unnecessary fitment may lift vehicle too high

## CONTROL ARMS

Pro-Forge Upper Control Arms			<b>UCA041FAS</b>	1	\$882.00
------------------------------	--	--	------------------	---	----------

## REAR SUSPENSION

## SHOCK ABSORBER

Nitro Gas - Comfort			<b>12746GRC</b>	2	\$153.00
Nitro Gas - Performance			<b>12746GR</b>	2	\$153.00
Foam Cell - Comfort			<b>24746FEC</b>	2	\$222.00
Foam Cell - Performance			<b>24746FE</b>	2	\$222.00
Foam Cell Pro - Comfort			<b>45746FEC</b>	2	\$305.00
Foam Cell Pro - Performance			<b>45746FE</b>	2	\$305.00

## COIL SPRINGS

	Est. Lift	Additional Load			
Medium	40mm	0 - 250kg	<b>HOLD008B</b>	1	\$250.00
Heavy	40mm	250kg - GVM	<b>HOLD008C</b>	1	\$250.00

## SUSPENSION KIT

Medium - Nitro Gas	<b>HOLD020BKG</b>	\$1247.00
Medium - Foam Cell	<b>HOLD020BKF</b>	\$1441.00
Medium - Foam Cell Pro	<b>HOLD020BKP</b>	\$1884.00
Heavy - Nitro Gas	<b>HOLD020CKG</b>	\$1247.00
Heavy - Foam Cell	<b>HOLD020CKF</b>	\$1441.00
Heavy - Foam Cell Pro	<b>HOLD020CKP</b>	\$1884.00

- Specify front Coil Springs when ordering

## SUSPENSION KIT CONTENTS

Shock Absorbers

Coil Springs

Torsion Bars

# Isuzu Trooper

1992+



Product Description

Part No.

Qty  
Req

Retail  
ea Inc GST

## SUSPENSION TO SUIT ISUZU TROOPER

### FRONT SUSPENSION

#### SHOCK ABSORBER

Nitro Gas - Performance	<b>12643GR</b>	2	\$153.00
Foam Cell - Performance	<b>24643FE</b>	2	\$222.00

#### TORSION BAR

Up-rated Torsion Bars	<b>HOLD009</b>	1	\$416.00
-----------------------	----------------	---	----------

• Minimum 60mm downward suspension travel required after adjustment

### REAR SUSPENSION

#### SHOCK ABSORBER

Nitro Gas - Performance	<b>12644GR</b>	2	\$153.00
Foam Cell - Performance	<b>24644FE</b>	2	\$222.00

#### COIL SPRINGS

	Est. Lift	Additional Load			
Medium	40mm	0 - 300kg	<b>HOLD008B</b>	1	\$250.00
Heavy	40mm	300kg - GVM	<b>HOLD008C</b>	1	\$250.00

• Use HOLD008C for 3/2001+ Models

### SUSPENSION KIT

Medium - Nitro Gas	<b>HOLD008BKG</b>	\$1275.00
Medium - Foam Cell	<b>HOLD008BKF</b>	\$1552.00
Heavy - Nitro Gas	<b>HOLD008CKG</b>	\$1275.00
Heavy - Foam Cell	<b>HOLD008CKF</b>	\$1552.00

### SUSPENSION KIT CONTENTS

Shock Absorbers

Leaf Springs

Torsion Bars

## Isuzu Trooper



11/1986 to 1991

## Product Description

## Part No.

Qty  
ReqRetail  
ea Inc GST

## SUSPENSION TO SUIT ISUZU TROOPER

## FRONT SUSPENSION

## SHOCK ABSORBER

Nitro Gas - Performance		<b>12087GR</b>	2	\$153.00
Foam Cell - Performance		<b>24087FE</b>	2	\$222.00

## TORSION BAR

Uprated Torsion Bars	33mm Spline	<b>HOLD005A</b>	1	\$416.00
Uprated Torsion Bars	33mm Spline	<b>HOLD007</b>	1	\$693.00

• Minimum 60mm downward suspension travel required after adjustment

## REAR SUSPENSION

## SHOCK ABSORBER

Nitro Gas - Performance		<b>12671GR</b>	2	\$153.00
-------------------------	--	----------------	---	----------

## LEAF SPRINGS

	Est. Lift	Additional Load		
Medium - Drivers Side	40mm	0 - 300kg	<b>HOLD004BD/S</b>	1
Medium - Near Side	40mm	0 - 300kg	<b>HOLD004BN/S</b>	1
Heavy - Drivers Side	40mm	300kg - GVM	<b>HOLD004CD/S</b>	1
Heavy - Near Side	40mm	300kg - GVM	<b>HOLD004CN/S</b>	1

## U-BOLTS

U-Bolt Kit		<b>451UBK</b>	2	\$42.00
------------	--	---------------	---	---------

## POLYURETHANE SPRING BUSHES

Bush Kit		<b>747UK</b>	1	\$84.00
----------	--	--------------	---	---------

## GREASABLE SHACKLES AND PINS

Greasable Shackle		<b>791</b>	2	\$56.00
Greasable Pin		<b>792</b>	2	\$42.00

## HELPER SPRINGS

Load Plus Helper Springs		<b>LP3</b>	1	\$157.00
Add-A-Leaf		<b>ISL6010</b>	1	\$167.00

## SUSPENSION KIT

Medium - Nitro Gas		<b>HOLD007BKG</b>		\$2217.00
Medium - Foam Cell		<b>HOLD007BKF</b>		\$2355.00
Heavy - Nitro Gas		<b>HOLD007CKG</b>		\$1868.00
Heavy - Foam Cell		<b>HOLD007CKF</b>		\$2411.00

## SUSPENSION KIT CONTENTS

Shock Absorbers

Torsion Bars

Polyurethane Spring Bushes

Leaf Springs

U-Bolts



Product Description

Part No.

Qty  
Req

Retail  
ea Inc GST

## SUSPENSION TO SUIT ISUZU TROOPER

### FRONT SUSPENSION

#### SHOCK ABSORBER

Nitro Gas - Performance	<b>12087GR</b>	2	\$153.00
Foam Cell - Performance	<b>24087FE</b>	2	\$222.00

#### TORSION BAR

Up-rated Torsion Bars	<b>MAZDA005</b>	1	\$416.00
-----------------------	-----------------	---	----------

• Minimum 60mm downward suspension travel required after adjustment

### REAR SUSPENSION

#### SHOCK ABSORBER

Nitro Gas - Comfort	<b>12636GRC</b>	2	\$153.00
Nitro Gas - Performance	<b>12636GR</b>	2	\$153.00
Foam Cell - Comfort	<b>24636FEC</b>	2	\$222.00
Foam Cell - Performance	<b>24636FE</b>	2	\$222.00

#### LEAF SPRINGS

	Est. Lift	Additional Load			
Medium - Drivers Side	40mm	0 - 300kg	<b>HOLD004BD/S</b>	1	\$375.00
Medium - Near Side	40mm	0 - 300kg	<b>HOLD004BN/S</b>	1	\$375.00
Heavy - Drivers Side	40mm	300kg - GVM	<b>HOLD004CD/S</b>	1	\$402.00
Heavy - Near Side	40mm	300kg - GVM	<b>HOLD004CN/S</b>	1	\$402.00

#### U-BOLTS

U-Bolt Kit	<b>451UBK</b>	2	\$42.00
------------	---------------	---	---------

#### POLYURETHANE SPRING BUSHES

Bush Kit	<b>747UK</b>	1	\$84.00
----------	--------------	---	---------

#### GREASABLE SHACKLES AND PINS

Greasable Shackle	<b>791</b>	2	\$56.00
Greasable Pin	<b>792</b>	2	\$42.00

#### HELPER SPRINGS

Load Plus Helper Springs	<b>LP3</b>	1	\$157.00
Add-A-Leaf	<b>ISL6010</b>	1	\$167.00

### SUSPENSION KIT

Medium - Nitro Gas	<b>HOLD005BKG</b>	\$1940.00
Medium - Foam Cell	<b>HOLD005BKF</b>	\$2217.00
Heavy - Nitro Gas	<b>HOLD005CKG</b>	\$1995.00
Heavy - Foam Cell	<b>HOLD005CKF</b>	\$2272.00

### SUSPENSION KIT CONTENTS

Shock Absorbers	Torsion Bars	Polyurethane Spring Bushes
Leaf Springs	U-Bolts	





Liberty KK  
2007 to 2012

# Jeep Cherokee

Product Description

Part No.

Qty  
Req

Retail  
ea Inc GST

## SUSPENSION TO SUIT JEEP CHEROKEE

### FRONT SUSPENSION

#### SHOCK ABSORBER

Nitro Gas - Performance		<b>12711GR</b>	2	\$222.00
• Height adjustable with Ironman 4x4 Strut Trim Packers				

#### TRIM PACKERS

5mm Strut Trim Packer	Nitro Gas	<b>HILFR05</b>	2	\$28.00
10mm Strut Trim Packer	Nitro Gas	<b>HILFR10</b>	2	\$28.00
15mm Strut Trim Packer	Nitro Gas	<b>HILFR15</b>	2	\$28.00
• ONLY Compatible with Ironman 4x4 Struts, lift height subject to 2:1 motion ratio. Unnecessary fitment may lift vehicle too high				

### REAR SUSPENSION

#### SHOCK ABSORBER

Nitro Gas - Performance		<b>12712GR</b>	2	\$153.00
• Vehicles with monocoque body construction can be subject to increased NVH (Noise) with upgraded suspension installed				





Product Description

Part No.

Qty  
Req

Retail  
ea Inc GST

## SUSPENSION TO SUIT JEEP CHEROKEE

### FRONT SUSPENSION

#### SHOCK ABSORBER

Nitro Gas Strut - Performance **12711GR** 2 \$222.00

• Height adjustable with Ironman 4x4 Strut Trim Packers

#### COIL SPRINGS

	Est. Lift	Additional Load	Part No.	Qty	Price
Medium	40mm	0 - 50kg	<b>JEEP014B</b>	1	\$250.00
Heavy or Diesel	40mm	50 - 100kg	<b>JEEP014C</b>	1	\$250.00

#### TRIM PACKERS

Trim Packer	Gas Type	Part No.	Qty	Price
5mm Strut Trim Packer	Nitro Gas	<b>HILFR05</b>	2	\$28.00
10mm Strut Trim Packer	Nitro Gas	<b>HILFR10</b>	2	\$28.00
15mm Strut Trim Packer	Nitro Gas	<b>HILFR15</b>	2	\$28.00

• ONLY Compatible with Ironman 4x4 Struts, lift height subject to 2:1 motion ratio. Unnecessary fitment may lift vehicle too high

### REAR SUSPENSION

#### SHOCK ABSORBER

Nitro Gas - Performance **12712GR** 2 \$153.00

#### COIL SPRINGS

	Est. Lift	Additional Load	Part No.	Qty	Price
Medium	40mm	0 - 200kg	<b>JEEP015B</b>	1	\$250.00

### SUSPENSION KIT

Medium - Nitro Gas	<b>JEEP014BKG</b>	\$1247.00
Medium - Nitro Gas (Diesel)	<b>JEEP014BKG1</b>	\$1247.00

• Vehicles with monocoque body construction can be subject to increased NVH (Noise) with upgraded suspension installed  
• Specify front Coil Springs when ordering

### SUSPENSION KIT CONTENTS

Shock Absorbers

Coil Springs

# Jeep Cherokee



XJ  
1984+

Product Description

Part No.

Qty  
Req

Retail  
ea Inc GST

## SUSPENSION TO SUIT JEEP CHEROKEE

### FRONT SUSPENSION

#### SHOCK ABSORBER

Nitro Gas - Performance			<b>12665GR</b>	2	\$153.00
Foam Cell - Performance			<b>24665FE</b>	2	\$222.00

#### COIL SPRINGS

	Est. Lift	Additional Load			
Medium	45mm	0 - 100kg	<b>JEEP016B</b>	1	\$250.00

#### STEERING DAMPER

Foam Cell			<b>3540</b>	1	\$167.00
-----------	--	--	-------------	---	----------

### REAR SUSPENSION

#### SHOCK ABSORBER

Nitro Gas - Performance			<b>12666GR</b>	2	\$153.00
Foam Cell - Performance			<b>24666FE</b>	2	\$222.00

#### LEAF SPRINGS

	Est. Lift	Additional Load			
Medium - Drivers Side	45mm	0 - 250kg	<b>JEEP004BD/S</b>	1	\$402.00
Medium - Near Side	45mm	0 - 250kg	<b>JEEP004BN/S</b>	1	\$402.00

• In some cases a driveline vibration may occur after lift, a gearbox crossmember spacer may be required

#### U-BOLTS

U-Bolt Kit			<b>512UBK</b>	2	\$42.00
------------	--	--	---------------	---	---------

#### POLYURETHANE SPRING BUSHES

Bush Kit			<b>762UK</b>	1	\$167.00
----------	--	--	--------------	---	----------

### SUSPENSION KIT

Medium - Nitro Gas			<b>JEEP003BKG</b>		\$1912.00
Medium - Foam Cell			<b>JEEP003BKF</b>		\$2189.00

• In some cases a driveline vibration may occur after lift, a gearbox crossmember spacer may be required

### SUSPENSION KIT CONTENTS

Shock Absorbers	Coil Springs	Polyurethane Spring Bushes
Leaf Springs	U-Bolts	



Product Description

Part No.

Qty  
Req

Retail  
ea Inc GST

## ACCESSORIES TO SUIT JEEP GLADIATOR

### STEEL WINCH BULL BARS

Raid Full Length Steel Bumper	<b>BBR077</b>		\$1424.00
Raid Stubby Bumper*	<b>BBR077ST</b>		-
Driving Light Patch Loom	<b>IPL077</b>		\$36.00

\* Stubby Bull Bar is non-compliant to Australian regulations therefore not available in Australia

• Raid Bull Bars are compatible with Ironman 4x4 Lightbars and Cube Lights, refer below for available options

### LIGHTING OPTIONS - TO SUIT RAID BULL BARS

105W Bright Sabre-X Single Row Slim Lightbar 522mm (20") Straight	<b>ILBSR003B</b>	1	\$217.00
40W Bright Cube Spot Beam LED Cube Light - 81 x 75mm (Each) - Clear	<b>ILED80B</b>	2	\$82.00
40W Bright Cube Spot Beam LED Cube Light - 81 x 75mm (Each) - Amber	<b>ILED80BA</b>	2	\$82.00
40W Bright Cube Flood Beam LED Cube Light - 81 x 75mm (Each) - Clear	<b>ILED80BF</b>	2	\$82.00
40W Bright Cube Flood Beam LED Cube Light - 81 x 75mm (Each) - Amber	<b>ILED80BFA</b>	2	\$82.00

### STEEL SIDE STEPS

Raid Rock Sliders	<b>SS077JT</b>		\$959.00
-------------------	----------------	--	----------

### REAR PROTECTION

Raid Steel Rear Bumper*	<b>RTB077JT</b>		\$1055.00
-------------------------	-----------------	--	-----------

\* Not compatible with Rubicon rear corner steps

• Compatible with Ironman 4x4 Cube Lights, refer below for available options

### LIGHTING OPTIONS - TO SUIT RAID REAR BARS

20W Bright Cube Spot Beam LED Cube Light - 70 x 64mm (Each) - Clear	<b>ILED20B</b>	2	\$61.00
20W Bright Cube Spot Beam LED Cube Light - 70 x 64mm (Each) - Amber	<b>ILED20BA</b>	2	\$61.00
20W Bright Cube Flood Beam LED Cube Light - 70 x 64mm (Each) - Clear	<b>ILED20BF</b>	2	\$61.00
20W Bright Cube Flood Beam LED Cube Light - 70 x 64mm (Each) - Amber	<b>ILED20BFA</b>	2	\$61.00
20W Bright Cube Flood Beam LED Cube Light - 70 x 64mm (Each) - Red	<b>ILED20BFR</b>	2	\$61.00

### SLIDE-AWAY ROLL UP HARD TONNEAU COVER

Electric with Remote Control	<b>ISLIDEAWAY077-E</b>		\$2599.00
------------------------------	------------------------	--	-----------

### DIFF BREATHER KIT

Diff Breather Kit	<b>IDIFFBRE</b>		\$115.00
-------------------	-----------------	--	----------







JT  
4/2019+

# Jeep Gladiator

Product Description

Part No.

Qty  
ReqRetail  
ea Inc GST

## SUSPENSION TO SUIT JEEP GLADIATOR

### FRONT SUSPENSION

#### SHOCK ABSORBER

Nitro Gas - Comfort			<b>12851GRC</b>	2	\$153.00
Nitro Gas - Performance			<b>12851GR</b>	2	\$153.00
Foam Cell Pro - Comfort			<b>45851FEC</b>	2	\$305.00
Foam Cell Pro - Performance			<b>45851FE</b>	2	\$305.00

#### COIL SPRINGS

	Est. Lift	Additional Load			
Medium	50mm	0 - 60kg	<b>JEEP031B</b>	1	\$250.00

#### STEERING DAMPER

Foam Cell		Left Hand Drive	<b>3544</b>	1	\$167.00
Foam Cell		Right Hand Drive	<b>3543</b>	1	\$167.00

### REAR SUSPENSION

#### SHOCK ABSORBER

Foam Cell Pro - Comfort			<b>45854FEC</b>	2	\$305.00
Foam Cell Pro - Performance			<b>45854FE</b>	2	\$305.00

#### COIL SPRINGS

	Est. Lift	Additional Load			
Medium	50mm	0 - 300kg	<b>JEEP032B</b>	1	\$250.00
Heavy	50mm	300kg - 600kg	<b>JEEP032C</b>	1	\$250.00
Extra Heavy	50mm	600kg - GVM	<b>JEEP032D</b>	1	\$250.00

### SUSPENSION KITS

Medium - Foam Cell Pro			<b>JEEP032BKP</b>	1	\$1718.00
Heavy - Foam Cell Pro			<b>JEEP032CKP</b>	1	\$1718.00
Extra Heavy - Foam Cell Pro			<b>JEEP032DKP</b>	1	\$1718.00

### SUSPENSION KIT CONTENTS

Shock Absorbers

Coil Springs

# Jeep Grand Cherokee

WK2  
8/2013+



Product Description

Part No.

Qty  
Req

Retail  
ea Inc GST

## ACCESSORIES TO SUIT JEEP GRAND CHEROKEE

**STEEL WINCH BULL BARS - ONLY FITS DIESEL LAREDO WITHOUT QUADRA-LIFT SUSPENSION (NO SENSOR HOLES PRE-DRILLED)**

Commercial Deluxe

**BBCD052**

\$2244.00

• Does not suit vehicles with forward facing radar

**DIFF BREATHER KIT**

Diff Breather Kit

**IDIFFBRE**

\$115.00



(4x4) WK2  
2011+

# Jeep Grand Cherokee

Product Description

Part No.

Qty  
ReqRetail  
ea Inc GST

## SUSPENSION TO SUIT JEEP GRAND CHEROKEE

### FRONT SUSPENSION

#### SHOCK ABSORBER

Nitro Gas - Performance	2011-2016 (Without Sway Bar Bracket)	<b>12735GR</b>	2	\$250.00
Nitro Gas - Performance	2016 + (With Sway Bar Bracket)	<b>12738GR LH/RH</b>	2	\$250.00

• 2016+ vehicles have sway bar bracket attached to lower clevis.

#### STRUT MOUNTS

Steel Strut Top		<b>ISST052</b>	2	\$111.00
-----------------	--	----------------	---	----------

#### COIL SPRINGS

	Est. Lift	Additional Load		
Medium	40mm	0 - 50kg	<b>JEEP025B</b>	1
Heavy or Diesel	40mm	50 - 100kg	<b>JEEP025C</b>	1

### REAR SUSPENSION

#### SPACER KIT

Shock Absorber Spacer		<b>1202K</b>	1	\$97.00
-----------------------	--	--------------	---	---------

• No rear shock absorbers available due to Nivomat Shock Absorbers and the affect on vehicle tow rating.

1202K is used to space shock absorber mount to accommodate lift.

#### COIL SPRINGS

	Est. Lift	Additional Load		
Medium	40mm	0 - 300kg	<b>JEEP026B</b>	1
Heavy	40mm	300 - 600kg	<b>JEEP026C</b>	1

• Nivomat self-levelling rear shock absorber equipped models only. Nivomat shock absorber has a 63mm body size.

Not compatible with 51mm standard shock absorber body.

### SUSPENSION KIT

Medium - Nitro Gas	<b>JEEP025BKG</b>	\$1095.00
Heavy - Nitro Gas	<b>JEEP025CKG</b>	\$1095.00

• Vehicles with monocoque body construction can be subject to increased NVH (Noise) with upgraded suspension installed.

### SUSPENSION KIT CONTENTS

Strut Shock Absorbers                      Shock Absorber Spacers                      Coil Springs

# Jeep Grand Cherokee

WJ / WG  
1999 to 6/2005



Product Description

Part No.

Qty  
Req

Retail  
ea Inc GST

## SUSPENSION TO SUIT JEEP GRAND CHEROKEE

### FRONT SUSPENSION

#### SHOCK ABSORBER

Nitro Gas - Performance

**12774GR** 2 \$153.00

#### COIL SPRINGS

	Est. Lift	Additional Load			
Medium	40mm	0 - 50kg	<b>JEEP012B</b>	1	\$250.00
Heavy	40mm	50 - 100kg	<b>JEEP012C</b>	1	\$250.00

### REAR SUSPENSION

#### SHOCK ABSORBER

Nitro Gas - Performance

**12775GR** 2 \$153.00

#### COIL SPRINGS

	Est. Lift	Additional Load			
Medium	40mm	0 - 200kg	<b>JEEP013B</b>	1	\$250.00
Heavy	40mm	200kg - GVM	<b>JEEP013C</b>	1	\$250.00

### SUSPENSION KIT

Medium - Nitro Gas

**JEEP012BKG** \$1109.00

• Vehicles with monocoque body construction can be subject to increased NVH (Noise) with upgraded suspension installed

### SUSPENSION KIT CONTENTS

Shock Absorbers

Coil Springs





ZJ/ZG  
1993 to 1998

# Jeep Grand Cherokee

Product Description

Part No.

Qty  
Req

Retail  
ea Inc GST

## SUSPENSION TO SUIT JEEP GRAND CHEROKEE

### FRONT SUSPENSION

#### SHOCK ABSORBER

Nitro Gas - Performance			<b>12665GR</b>	2	\$153.00
Foam Cell - Performance			<b>24665FE</b>	2	\$222.00

#### COIL SPRINGS

	Est. Lift	Additional Load			
Medium	40mm	0 - 50kg	<b>JEEP003B</b>	1	\$250.00
Heavy	40mm	50 - 100kg	<b>JEEP016B</b>	1	\$250.00

#### STEERING DAMPER

Foam Cell			<b>3540</b>	1	\$167.00
-----------	--	--	-------------	---	----------

### REAR SUSPENSION

#### SHOCK ABSORBER

Nitro Gas - Performance			<b>12670GR</b>	2	\$153.00
-------------------------	--	--	----------------	---	----------

#### COIL SPRINGS

	Est. Lift	Additional Load			
Medium	40mm	0 - 300kg	<b>JEEP006B</b>	1	\$250.00
Heavy	40mm	300kg - GVM	<b>JEEP003B</b>	1	\$250.00

### SUSPENSION KIT

Medium - Nitro Gas	<b>JEEP006BKG</b>	\$1109.00
Heavy - Nitro Gas	<b>JEEP006CKG</b>	\$1109.00

- Vehicles with monocoque body construction can be subject to increased NVH (Noise) with upgraded suspension installed
- Specify front Coil Springs when ordering

### SUSPENSION KIT CONTENTS

Shock Absorbers

Coil Springs





Product Description

Part No.

Qty  
Req

Retail  
ea Inc GST

## ACCESSORIES TO SUIT JEEP WRANGLER

### STEEL WINCH BULL BARS

Raid Full Length Steel Bumper	<b>BBR077</b>		\$1424.00
Raid Stubby Bumper*	<b>BBR077ST</b>		-
Driving Light Patch Loom	<b>IPL077</b>		\$36.00

\* Stubby Bull Bar is non-compliant to Australian regulations therefore not available in Australia

• Raid Bull Bars are compatible with Ironman 4x4 Lightbars and Cube Lights, refer below for available options

### LIGHTING OPTIONS - TO SUIT RAID BULL BARS

105W Bright Sabre-X Single Row Slim Lightbar 522mm (20") Straight	<b>ILBSR003B</b>	1	\$217.00
40W Bright Cube Spot Beam LED Cube Light - 81 x 75mm (Each) - Clear	<b>ILED80B</b>	2	\$82.00
40W Bright Cube Spot Beam LED Cube Light - 81 x 75mm (Each) - Amber	<b>ILED80BA</b>	2	\$82.00
40W Bright Cube Flood Beam LED Cube Light - 81 x 75mm (Each) - Clear	<b>ILED80BF</b>	2	\$82.00
40W Bright Cube Flood Beam LED Cube Light - 81 x 75mm (Each) - Amber	<b>ILED80BFA</b>	2	\$82.00

### STEEL SIDE STEPS

Raid Rock Sliders	<b>SS077JL</b>		\$959.00
-------------------	----------------	--	----------

• 4 Door models only

### REAR PROTECTION AND TOWING

Raid Steel Rear Bumper*	<b>RTB077JL</b>		\$1055.00
Class 3 Tow Bar (3500lb)	<b>TB077JL</b>		\$175.00
Spare Tyre and Licence Plate Relocation Kit †	<b>RWC077JL</b>		\$321.00

† Compatible up to 37" tyres

\* Recommend installation of RWC077JL to raise spare wheel and licence plate relocation

• Compatible with Ironman 4x4 Cube Lights, refer below for available options

### LIGHTING OPTIONS - TO SUIT RAID REAR BARS

20W Bright Cube Spot Beam LED Cube Light - 70 x 64mm (Each) - Clear	<b>ILED20B</b>	2	\$61.00
20W Bright Cube Spot Beam LED Cube Light - 70 x 64mm (Each) - Amber	<b>ILED20BA</b>	2	\$61.00
20W Bright Cube Flood Beam LED Cube Light - 70 x 64mm (Each) - Clear	<b>ILED20BF</b>	2	\$61.00
20W Bright Cube Flood Beam LED Cube Light - 70 x 64mm (Each) - Amber	<b>ILED20BFA</b>	2	\$61.00
20W Bright Cube Flood Beam LED Cube Light - 70 x 64mm (Each) - Red	<b>ILED20BFR</b>	2	\$61.00



## Jeep Wrangler

JL  
2018+

Product Description

Part No.

Qty  
ReqRetail  
ea Inc GST

## SUSPENSION TO SUIT JEEP WRANGLER

## FRONT SUSPENSION

## SHOCK ABSORBER

Nitro Gas - Comfort			<b>12851GRC</b>	2	\$153.00
Nitro Gas - Performance			<b>12851GR</b>	2	\$153.00
Foam Cell Pro - Comfort			<b>45851FEC</b>	2	\$305.00
Foam Cell Pro - Performance			<b>45851FE</b>	2	\$305.00

## COIL SPRINGS

	Est. Lift	Additional Load			
Light	45mm	0 - 50kg	<b>JEEP029A</b>	1	\$250.00
Medium	50mm	0 - 50kg	<b>JEEP029B</b>	1	\$250.00
Heavy	50mm	50 - 100kg	<b>JEEP029C</b>	1	\$250.00

## STEERING DAMPER

Foam Cell	Left Hand Drive	<b>3544</b>	1	\$167.00
Foam Cell	Right Hand Drive	<b>3543</b>	1	\$167.00

## REAR SUSPENSION

## SHOCK ABSORBER

Nitro Gas - Comfort			<b>12852GRC</b>	2	\$153.00
Nitro Gas - Performance			<b>12852GR</b>	2	\$153.00
Foam Cell Pro - Comfort			<b>45852FEC</b>	2	\$305.00
Foam Cell Pro - Performance			<b>45852FE</b>	2	\$305.00

## COIL SPRINGS

	Est. Lift	Additional Load			
Light - (2 Door Models)	45mm	0 - 100kg	<b>JEEP030A</b>	1	\$250.00
Medium	50mm	0 - 250kg	<b>JEEP030B</b>	1	\$250.00
Heavy	50mm	200kg - GVM	<b>JEEP030C</b>	1	\$250.00

## SUSPENSION KITS

Light - Nitro Gas	<b>JEEP030AKG</b>	1	\$1109.00
Light - Foam Cell Pro	<b>JEEP030AKP</b>	1	\$1718.00
Medium - Nitro Gas	<b>JEEP030BKG</b>	1	\$1109.00
Medium - Foam Cell Pro	<b>JEEP030BKP</b>	1	\$1718.00
Heavy - Nitro Gas	<b>JEEP030CKG</b>	1	\$1109.00
Heavy - Foam Cell Pro	<b>JEEP030CKP</b>	1	\$1718.00

## SUSPENSION KIT CONTENTS

Shock Absorbers                      Coil Springs

# Jeep Wrangler

JK  
2007+



Product Description

Part No.

Qty  
Req

Retail  
ea Inc GST

## ACCESSORIES TO SUIT JEEP WRANGLER

### STEEL WINCH BULL BARS - MUST USE OE FOG LIGHTS

Commercial Deluxe	<b>BBCD035</b>		\$2244.00
Raid Full Length Steel Bumper	<b>BBR077</b>		\$1424.00
Raid Stubby Bumper*	<b>BBR077ST</b>		-

\* Stubby Bull Bar is non-compliant to Australian regulations therefore not available in Australia

• Raid Bull Bars are compatible with Ironman 4x4 Lightbars and Cube Lights, refer below for available options

### LIGHTING OPTIONS - TO SUIT RAID BULL BARS

105W Bright Sabre-X Single Row Slim Lightbar 522mm (20") Straight	<b>ILBSR003B</b>	1	\$217.00
40W Bright Cube Spot Beam LED Cube Light - 81 x 75mm (Each) - Clear	<b>ILED80B</b>	2	\$82.00
40W Bright Cube Spot Beam LED Cube Light - 81 x 75mm (Each) - Amber	<b>ILED80BA</b>	2	\$82.00
40W Bright Cube Flood Beam LED Cube Light - 81 x 75mm (Each) - Clear	<b>ILED80BF</b>	2	\$82.00
40W Bright Cube Flood Beam LED Cube Light - 81 x 75mm (Each) - Amber	<b>ILED80BFA</b>	2	\$82.00

### SNORKEL

Not Available in Australia	<b>ISNORKELO32</b>		\$363.00
----------------------------	--------------------	--	----------

### DIFF BREATHER KIT

Diff Breather Kit	<b>IDIFFBRE</b>		\$115.00
-------------------	-----------------	--	----------





## Jeep Wrangler

JK  
2006+

Product Description

Part No.

Qty  
ReqRetail  
ea Inc GST

## SUSPENSION TO SUIT JEEP WRANGLER

## FRONT SUSPENSION

## SHOCK ABSORBER

Nitro Gas - Performance			<b>12751GR</b>	2	\$153.00
Nitro Gas - Performance	Suits 4" Lift		<b>12751LGR</b>	2	\$153.00
Foam Cell Pro - Performance			<b>45751FE</b>	2	\$305.00
Foam Cell Pro - Performance	Suits 4" Lift		<b>45751LFE</b>	2	\$319.00

## COIL SPRINGS

	Est. Lift	Additional Load			
Medium	40mm	0 - 50kg	<b>JEEP017B</b>	1	\$250.00
Medium - 4" Lift	100mm	0 - 50kg	<b>JEEP019B</b>	1	\$291.00
Heavy	40mm	50 - 110kg	<b>JEEP017C</b>	1	\$250.00

## STEERING DAMPER

Foam Cell	Regular Fitment	<b>3541</b>	1	\$167.00
Foam Cell	Suits JKBKITL 4" Kit Only	<b>3540</b>	1	\$167.00

## PANHARD ROD

Adjustable Panhard Rod		<b>PANHARD010</b>	1	\$319.00
------------------------	--	-------------------	---	----------

## REAR SUSPENSION

## SHOCK ABSORBER

Nitro Gas - Performance			<b>12752GR</b>	2	\$153.00
Nitro Gas - Performance	Suits 4" Lift		<b>12752LGR</b>	2	\$153.00
Foam Cell Pro - Performance			<b>45752FE</b>	2	\$305.00
Foam Cell Pro - Performance	Suits 4" Lift		<b>45752LFE</b>	2	\$319.00

## COIL SPRINGS

	Est. Lift	Additional Load			
Medium - 2 Door	40mm	0 - 250kg	<b>JEEP018A</b>	1	\$250.00
Medium - 4 Door	40mm	0 - 250kg	<b>JEEP018B</b>	1	\$250.00
Medium - 4" Lift	100mm	0 - 250kg	<b>JEEP020B</b>	1	\$291.00

## PANHARD ROD

Adjustable Panhard Rod		<b>PANHARD011</b>	1	\$319.00
------------------------	--	-------------------	---	----------

## SWAY BAR LINK

Extended Sway Bar Link		<b>SBEXT008</b>	2	\$84.00
------------------------	--	-----------------	---	---------

- OEM Rear Links can be moved to the front of vehicle.

## BRACKET KIT

4" Lift Bracket Set	Left Hand Drive Models ONLY	<b>JKBKITL</b>	1	\$1926.00
---------------------	-----------------------------	----------------	---	-----------

- Bracket set is sold complete. Parts are not available individually

## SUSPENSION KIT

Light - Nitro Gas	2 Door	<b>JEEP017AKG</b>	\$1109.00
Light - Foam Cell Pro	2 Door	<b>JEEP017AKP</b>	\$1718.00
Medium - Nitro Gas	4 Door	<b>JEEP017BKG</b>	\$1109.00
Medium - Nitro Gas	4" Lift	<b>JEEP019BKGL</b>	\$3283.00
Medium - Foam Cell Pro	4 Door	<b>JEEP017BKP</b>	\$1718.00
Medium - Foam Cell Pro	4" Lift	<b>JEEP019BKPL</b>	\$3948.00

- 4" Lift may not be legal for road use in your area. Certification may be required for on-road use
- 4" Lift Kit suits left hand drive models ONLY
- 4" Lift components should only be used together with appropriate geometry correction components

## SUSPENSION KIT CONTENTS

Shock Absorbers

Coil Springs

## 4" SUSPENSION KIT CONTENTS

Shock Absorbers  
Coil SpringsSteering Damper  
4" Bracket Set

## 4" BRACKET SET CONTENTS

Steering Rod Flip Kit - JKBK01L  
Front Shock Absorber Relocation Kit - JKBK02  
Radius Arm Relocation Kit - JKBK03  
Brake Hose Extension Kit - JKBK04  
Front Adjustable Panhard Rod - PANHARD010

- Fitment to RHD is possible with omission of JKBK01L and JKBK05L

Rear Adjustable Panhard Rod - PANHARD012  
Rear Panhard Rod Relocation Kit - JKBK05L  
Bump Stop Spacer Kit - JKBK06  
Adjustable Swaybar Extensions - SBEXT008





2014+

## Product Description

Part No.

Qty  
ReqRetail  
ea Inc GST

## SUSPENSION TO SUIT JMC VIGUS

## FRONT SUSPENSION

## SHOCK ABSORBER

Nitro Gas Strut - Performance			<b>12710GR</b>	2	\$222.00
Foam Cell Strut - Performance			<b>24710FE</b>	2	\$250.00
Foam Cell Pro Strut - Performance			<b>45710FE</b>	2	\$388.00

- Height adjustable with Ironman 4x4 Strut Trim Packers

## COIL SPRINGS

	Est. Lift	Additional Load			
Medium	45mm	0 - 50kg	<b>TOY038C</b>	1	\$250.00
Heavy	45mm	50 - 110kg	<b>TOY055A</b>	1	\$250.00

## STRUT MOUNTS

Steel Strut Top			<b>ISST001</b>	2	\$84.00
-----------------	--	--	----------------	---	---------

## TRIM PACKERS

5mm Strut Trim Packer	Nitro Gas / Foam Cell	<b>HILFR05 / HILFR05F</b>	2	\$28.00
10mm Strut Trim Packer	Nitro Gas / Foam Cell	<b>HILFR10 / HILFR10F</b>	2	\$28.00
15mm Strut Trim Packer	Nitro Gas / Foam Cell	<b>HILFR15 / HILFR15F</b>	2	\$28.00

- ONLY Compatible with Ironman 4x4 Struts (except Pro), lift height subject to 2:1 motion ratio. Unnecessary fitment may lift vehicle too high

## REAR SUSPENSION

## SHOCK ABSORBER

Nitro Gas - Comfort			<b>12650GRC</b>	2	\$153.00
Nitro Gas - Performance			<b>12650GR</b>	2	\$153.00
Foam Cell - Comfort			<b>24650FEC</b>	2	\$222.00
Foam Cell - Performance			<b>24650FE</b>	2	\$222.00
Foam Cell - Professional			<b>24650FEP</b>	2	\$222.00
Foam Cell Pro - Comfort			<b>45650FEC</b>	2	\$305.00
Foam Cell Pro - Performance			<b>45650FE</b>	2	\$305.00
Foam Cell Pro - Professional			<b>45650FEP</b>	2	\$305.00

## LEAF SPRINGS

	Est. Lift	Additional Load			
Medium	40mm	0 - 200kg	<b>JMC002B</b>	2	\$375.00
Heavy	40mm	200 - 400kg	<b>JMC002C</b>	2	\$402.00

## U-BOLTS

U-Bolt Kit			<b>437UBKL</b>	2	\$42.00
------------	--	--	----------------	---	---------

## POLYURETHANE SPRING BUSHES

Bush Kit			<b>767UK</b>	1	\$84.00
----------	--	--	--------------	---	---------

## GREASABLE SHACKLES AND PINS

Greasable Shackle			<b>386-3</b>	2	\$56.00
Non-Greasable Pin			<b>387-1</b>	2	\$28.00

## HELPER SPRINGS

Load Plus Helper Springs			<b>LP2</b>	1	\$157.00
Add-A-Leaf			<b>ISL6010</b>	1	\$167.00

## SUSPENSION KIT

Medium - Nitro Gas		<b>JMC002BKG</b>	\$1912.00
Medium - Foam Cell		<b>JMC002BKF</b>	\$2106.00
Medium - Foam Cell Pro		<b>JMC002BKP</b>	\$2549.00
Heavy - Nitro Gas		<b>JMC002CKG</b>	\$1967.00
Heavy - Foam Cell		<b>JMC002CKF</b>	\$2161.00
Heavy - Foam Cell Pro		<b>JMC002CKP</b>	\$2605.00

- Specify Front Coil Springs when ordering

## SUSPENSION KIT CONTENTS

Shock Absorbers	Coil Springs	U-Bolts
Strut Shock Absorbers	Leaf Springs	Polyurethane Spring Bushes

# Kia Sorento

BL  
2003 to 2008



Product Description

Part No.

Qty  
Req

Retail  
ea Inc GST

## SUSPENSION TO SUIT KIA SORENTO

### FRONT SUSPENSION

**COIL SPRINGS**

	Est. Lift	Additional Load	Part No.	Qty	Retail Price
Medium	35mm	0 - 50kg	<b>KIA006B</b>	1	\$250.00

### REAR SUSPENSION

**COIL SPRINGS**

	Est. Lift	Additional Load	Part No.	Qty	Retail Price
Medium	35mm	0 - 200kg	<b>KIA007B</b>	1	\$250.00





1978+

# Lada Niva

Product Description

Part No.

Qty  
Req

Retail  
ea Inc GST

## SUSPENSION TO SUIT LADA NIVA

### FRONT SUSPENSION

**COIL SPRINGS**

	Est. Lift	Additional Load	Part No.	Qty	Retail
Medium	35mm	0 - 50kg	<b>LADA001B</b>	1	\$250.00

### REAR SUSPENSION

**COIL SPRINGS**

	Est. Lift	Additional Load	Part No.	Qty	Retail
Medium	35mm	0 - 200kg	<b>LADA002B</b>	1	\$250.00



# Alu-Cab™

ULTIMATE OVERLAND PRODUCTS



*ICARUS*  
Roof conversion  
to Suit Defender 110

for a full range of alu-cab visit our website

[www.alu-cab.com.au](http://www.alu-cab.com.au)

distributed by





2007 to 2016

# Land Rover Defender

Product Description

Part No.

Qty  
ReqRetail  
ea Inc GST

## ACCESSORIES TO SUIT LAND ROVER DEFENDER

### STEEL WINCH BULL BARS - NON-AIRBAG MODELS ONLY

Commercial (Tube Style) - *While Stocks Last*

BBC023

\$1648.00

### LOCKSAFE DRAWER SYSTEMS

Twin Drawers - 1000mm

ITD1000

\$1296.00

Single Drawer - 1000mm

ISD1000

\$784.00

### STEEL ROOF RACKS

Cage Style - 1.4m x 1.25m

IRRCAGE14

\$777.00

Cage Style - 1.8m x 1.25m

IRRCAGE18

\$815.00

Cage Style - 2.2m x 1.25m

IRRCAGE22

\$846.00

Rooftop Tent Compatible - 1.8m x 1.25m

IRRTENT18

\$777.00

Rooftop Tent Compatible - 2.2m x 1.25m

IRRTENT22

\$815.00

Trade Style - 1.8m x 1.25m (Open end)

IRRTRADE18

\$777.00

Trade Style - 2.2m x 1.25m (Open end)

IRRTRADE22

\$809.00

### ALLOY ROOF RACKS

Cage Style - 1.4m x 1.25m

IRRCAGE14-ALLOY

\$983.00

Cage Style - 1.8m x 1.25m

IRRCAGE18-ALLOY

\$1149.00

Cage Style - 2.2m x 1.25m

IRRCAGE22-ALLOY

\$1212.00

Trade Style - 1.4m x 1.25m (Open end)

IRROPEN14-ALLOY

\$971.00

Trade Style - 1.8m x 1.25m (Open end)

IRRTRADE18-ALLOY

\$1132.00

Trade Style - 2.2m x 1.25m (Open end)

IRRTRADE22-ALLOY

\$1181.00

Flat Rack - 1.8m x 1.25m

IRRTFLAT18-ALLOY

\$1116.00

### ROOF RACK - MOUNTING KITS

Gutter Mount Feet - 210mm (8 Feet)

IRRFEET210

\$218.00

### DIFF BREATHER KIT

Diff Breather Kit

IDIFFBRE

\$115.00

# Land Rover Defender

110, 130 Series  
County / Dual Cab



Product Description

Part No.

Qty  
Req

Retail  
ea Inc GST

## SUSPENSION TO SUIT LAND ROVER DEFENDER

### FRONT SUSPENSION

**SHOCK ABSORBER**

Nitro Gas - Performance			<b>12080GR</b>	2	\$153.00
Foam Cell - Performance			<b>24080FE</b>	2	\$222.00
Foam Cell Pro - Performance			<b>45080FE</b>	2	\$305.00

**COIL SPRINGS**

	Est. Lift	Additional Load			
Medium - V8 Petrol Engine	45mm	0 - 80kg	<b>LAND007B</b>	1	\$250.00
Medium - 2.5 Puma Engine	45mm	0 - 80kg	<b>LAND009B</b>	1	\$250.00
Medium - 2.2 Puma Engine	45mm	0 - 80kg	<b>LAND014B</b>	1	\$250.00

**STEERING DAMPER**

Foam Cell			<b>3532</b>	1	\$167.00
-----------	--	--	-------------	---	----------

**OFFSET CASTER BUSH KIT**

Offset Bush Kit	Suits 1987+		<b>1145SK</b>	1	\$153.00
-----------------	-------------	--	---------------	---	----------

• May cause driveline vibration on 1998+ models

### REAR SUSPENSION

**SHOCK ABSORBER**

Nitro Gas - Performance			<b>12640GR</b>	2	\$153.00
Foam Cell - Performance			<b>24640FE</b>	2	\$222.00
Foam Cell Pro - Performance			<b>45640FE</b>	2	\$305.00

**COIL SPRINGS**

	Est. Lift	Additional Load			
Medium - (Self Leveling)	45mm	0 - 300kg	<b>LAND008B</b>	1	\$250.00
Medium	45mm	0 - 300kg	<b>LAND006B</b>	1	\$264.00
Heavy	45mm	300kg - GVM	<b>LAND006C</b>	1	\$278.00

• Re-Fit inner spring if equipped

### SUSPENSION KIT

Medium - Nitro Gas - (Self Leveling)	<b>LAND005BKG</b>	\$1109.00
Medium - Foam Cell - (Self Leveling)	<b>LAND005BKF</b>	\$1386.00
Medium - Foam Cell Pro - (Self Leveling)	<b>LAND005BKP</b>	\$1718.00
Medium - Nitro Gas	<b>LAND006BKG</b>	\$1123.00
Medium - Foam Cell	<b>LAND006BKF</b>	\$1400.00
Medium - Foam Cell Pro	<b>LAND006BKP</b>	\$1732.00
Heavy - Nitro Gas	<b>LAND006CKG</b>	\$1136.00
Heavy - Foam Cell	<b>LAND006CKF</b>	\$1413.00
Heavy - Foam Cell Pro	<b>LAND006CKP</b>	\$1746.00

• Specify front Coil Springs when ordering

### SUSPENSION KIT CONTENTS

Shock Absorbers

Coil Springs





110 Series Trayback

# Land Rover Defender

Product Description

Part No.

Qty  
ReqRetail  
ea Inc GST

## SUSPENSION TO SUIT LAND ROVER DEFENDER

### FRONT SUSPENSION

#### SHOCK ABSORBER

Nitro Gas - Performance			<b>12080GR</b>	2	\$153.00
Foam Cell - Performance			<b>24080FE</b>	2	\$222.00
Foam Cell Pro - Performance			<b>45080FE</b>	2	\$305.00

#### COIL SPRINGS

	Est. Lift	Additional Load			
Medium - V8 Petrol Engine	45mm	0 - 80kg	<b>LAND007B</b>	1	\$250.00
Medium - 2.5 Puma Engine	45mm	0 - 80kg	<b>LAND009B</b>	1	\$250.00
Medium - 2.2 Puma Engine	45mm	0 - 80kg	<b>LAND014B</b>	1	\$250.00

#### STEERING DAMPER

Foam Cell			<b>3532</b>	1	\$167.00
-----------	--	--	-------------	---	----------

#### OFFSET CASTER BUSH KIT

Offset Bush Kit	Suits 1987+		<b>1145SK</b>	1	\$153.00
-----------------	-------------	--	---------------	---	----------

• May cause driveline vibration on 1998+ models

### REAR SUSPENSION

#### SHOCK ABSORBER

Nitro Gas - Performance			<b>12640GR</b>	2	\$153.00
Foam Cell - Performance			<b>24640FE</b>	2	\$222.00
Foam Cell Pro - Performance			<b>45640FE</b>	2	\$305.00

#### COIL SPRINGS

	Est. Lift	Additional Load			
Medium	45mm	0 - 300kg	<b>LAND006B</b>	1	\$264.00
Heavy	45mm	300kg - GVM	<b>LAND006C</b>	1	\$278.00

### SUSPENSION KIT

Medium - Nitro Gas		<b>LAND007BKG</b>	\$1123.00
Medium - Foam Cell		<b>LAND007BKF</b>	\$1400.00
Medium - Foam Cell Pro		<b>LAND007BKP</b>	\$1732.00
Heavy - Nitro Gas		<b>LAND007CKG</b>	\$1136.00
Heavy - Foam Cell		<b>LAND007CKF</b>	\$1413.00
Heavy - Foam Cell Pro		<b>LAND007CKP</b>	\$1746.00

• Specify front Coil Springs when ordering

### SUSPENSION KIT CONTENTS

Shock Absorbers

Coil Springs



Product Description

Part No.

Qty  
Req

Retail  
ea Inc GST

## SUSPENSION TO SUIT LAND ROVER DEFENDER

### FRONT SUSPENSION

#### SHOCK ABSORBER

Nitro Gas - Performance			<b>12080GR</b>	2	\$153.00
Foam Cell - Performance			<b>24080FE</b>	2	\$222.00
Foam Cell Pro - Performance			<b>45080FE</b>	2	\$305.00

#### COIL SPRINGS

	Est. Lift	Additional Load			
Medium	45mm	0 - 80kg	<b>LAND009B</b>	1	\$250.00

#### STEERING DAMPER

Foam Cell			<b>3532</b>	1	\$167.00
-----------	--	--	-------------	---	----------

#### OFFSET CASTER BUSH KIT

Offset Bush Kit		Suits 1987+	<b>1145SK</b>	1	\$153.00
-----------------	--	-------------	---------------	---	----------

• May cause driveline vibration on 1998+ models

### REAR SUSPENSION

#### SHOCK ABSORBER

Nitro Gas - Performance			<b>12640GR</b>	2	\$153.00
Foam Cell - Performance			<b>24640FE</b>	2	\$222.00
Foam Cell Pro - Performance			<b>45640FE</b>	2	\$305.00

#### COIL SPRINGS

	Est. Lift	Additional Load			
Medium	45mm	0 - 300kg	<b>LAND011B</b>	1	\$250.00
Heavy	45mm	300kg - GVM	<b>LAND011C</b>	1	\$278.00

### SUSPENSION KIT

Medium - Nitro Gas	<b>LAND009BKG</b>	\$1109.00
Medium - Foam Cell	<b>LAND009BKF</b>	\$1386.00
Medium - Foam Cell Pro	<b>LAND009BKP</b>	\$1718.00
Heavy - Nitro Gas	<b>LAND009CKG</b>	\$1136.00
Heavy - Foam Cell	<b>LAND009CKF</b>	\$1413.00
Heavy - Foam Cell Pro	<b>LAND009CKP</b>	\$1746.00

### SUSPENSION KIT CONTENTS

Shock Absorbers

Coil Springs



(Coil Springs)  
1971 to 1995

# Land Rover Range Rover

Product Description

Part No.

Qty  
ReqRetail  
ea Inc GST

## SUSPENSION TO SUIT LAND ROVER RANGE ROVER

### FRONT SUSPENSION

#### SHOCK ABSORBER

Nitro Gas - Performance			<b>12080GR</b>	2	\$153.00
Foam Cell - Performance			<b>24080FE</b>	2	\$222.00
Foam Cell Pro - Performance			<b>45080FE</b>	2	\$305.00

#### COIL SPRINGS

	Est. Lift	Additional Load			
Medium	40mm	0 - 50kg	<b>LAND009B</b>	1	\$250.00
Heavy	40mm	50 - 110kg	<b>LAND007B</b>	1	\$250.00

#### STEERING DAMPER

Foam Cell			<b>3511</b>	1	\$167.00
-----------	--	--	-------------	---	----------

#### OFFSET CASTER BUSH KIT

Offset Bush Kit		Suits 1986+	<b>1145SK</b>	1	\$153.00
-----------------	--	-------------	---------------	---	----------

• May cause driveline vibration in automatic transmission models

### REAR SUSPENSION

#### SHOCK ABSORBER

Nitro Gas - Performance			<b>12640GR</b>	2	\$153.00
Foam Cell - Performance			<b>24640FE</b>	2	\$222.00
Foam Cell Pro - Performance			<b>45640FE</b>	2	\$305.00

#### COIL SPRINGS

	Est. Lift	Additional Load			
Medium	40mm	0 - 300kg	<b>LAND011B</b>	1	\$250.00
Heavy	40mm	300kg - GVM	<b>LAND011C</b>	1	\$278.00

### SUSPENSION KIT

Medium - Nitro Gas	<b>LAND009BKG</b>	\$1109.00
Medium - Foam Cell	<b>LAND009BKF</b>	\$1386.00
Medium - Foam Cell Pro	<b>LAND009BKP</b>	\$1718.00
Heavy - Nitro Gas	<b>LAND009CKG</b>	\$1136.00
Heavy - Foam Cell	<b>LAND009CKF</b>	\$1413.00
Heavy - Foam Cell Pro	<b>LAND009CKP</b>	\$1746.00

• Specify front Coil Springs when ordering

### SUSPENSION KIT CONTENTS

Shock Absorbers

Coil Springs

# Land Rover Discovery

Series 2, 3 and 4



Product Description

Part No.

Qty  
Req

Retail  
ea Inc GST

## ACCESSORIES TO SUIT LAND ROVER DISCOVERY

### UNDERBODY PROTECTION

Engine Bay and Transmission\* - *While Stocks Last*

\* Fits Discovery 3 / 4 / Range Rover Sport 2005 - 2013

**IUP016K**

\$636.00

### LOCKSAFE DRAWER SYSTEMS

Twin Drawers - 900mm - Fits Discovery 2 Only

Single Drawer - 900mm

**ITD900**

\$1242.00

**ISD900**

\$767.00

### DIFF BREATHER KIT

Diff Breather Kit

**IDIFFBRE**

\$115.00





Series 3 LR3 (Coil Springs)  
2004 to 2009

**SUSPENSION TO SUIT**

# Land Rover Discovery

Product Description

Part No.

Qty  
Req

Retail  
ea Inc GST

## SUSPENSION TO SUIT LAND ROVER DISCOVERY

### FRONT SUSPENSION

COIL SPRINGS	Est. Lift	Additional Load			
Medium	45mm	0 - 50kg	<b>LAND019B</b>	1	\$250.00
Heavy	45mm	50 - 100kg	<b>LAND019C</b>	1	\$231.00

### REAR SUSPENSION

COIL SPRINGS	Est. Lift	Additional Load			
Medium	45mm	0 - 200kg	<b>LAND020B</b>	1	\$291.00
Heavy	45mm	200kg - GVM	<b>LAND020C</b>	1	\$270.00



Product Description

Part No.

Qty  
Req

Retail  
ea Inc GST

## SUSPENSION TO SUIT LAND ROVER DISCOVERY

### FRONT SUSPENSION

**SHOCK ABSORBER**

Nitro Gas - Performance			<b>12776GR</b>	2	\$153.00
Foam Cell - Performance			<b>24776FE</b>	2	\$222.00

**COIL SPRINGS**

	Est. Lift	Additional Load			
Medium	40mm	0 - 50kg	<b>LAND014B</b>	1	\$250.00
Heavy	40mm	50 - 110kg	<b>LAND009B</b>	1	\$250.00

**STEERING DAMPER**

Foam Cell			<b>3502</b>	1	\$167.00
-----------	--	--	-------------	---	----------

### REAR SUSPENSION

**SHOCK ABSORBER**

Nitro Gas - Performance			<b>12777GR</b>	2	\$153.00
Foam Cell - Performance			<b>24777FE</b>	2	\$222.00

**COIL SPRINGS**

	Est. Lift	Additional Load			
Medium	40mm	0 - 300kg	<b>LAND011B</b>	1	\$250.00
Heavy	40mm	300kg - GVM	<b>LAND011C</b>	1	\$278.00

### SUSPENSION KIT

Medium - Nitro Gas	<b>LAND014BKG</b>	\$1109.00
Medium - Foam Cell	<b>LAND014BKF</b>	\$1386.00
Heavy - Nitro Gas	<b>LAND014CKG</b>	\$1136.00
Heavy - Foam Cell	<b>LAND014CKF</b>	\$1413.00

• Specify front Coil Springs when ordering

### SUSPENSION KIT CONTENTS

Shock Absorbers

Coil Springs



Series 1  
1989 to 1998

# Land Rover Discovery

Product Description

Part No.

Qty  
ReqRetail  
ea Inc GST

## SUSPENSION TO SUIT LAND ROVER DISCOVERY

### FRONT SUSPENSION

#### SHOCK ABSORBER

Nitro Gas - Performance			<b>12080GR</b>	2	\$153.00
Foam Cell - Performance			<b>24080FE</b>	2	\$222.00
Foam Cell Pro - Performance			<b>45080FE</b>	2	\$305.00

#### COIL SPRINGS

	Est. Lift	Additional Load			
Medium	40mm	0 - 50kg	<b>LAND009B</b>	1	\$250.00
Heavy	40mm	50 - 110kg	<b>LAND007B</b>	1	\$250.00

#### STEERING DAMPER

Foam Cell			<b>3511</b>	1	\$167.00
-----------	--	--	-------------	---	----------

#### OFFSET CASTER BUSH KIT

Offset Bush Kit			<b>1145SK</b>	1	\$153.00
-----------------	--	--	---------------	---	----------

• May cause driveline vibration in automatic transmission models

### REAR SUSPENSION

#### SHOCK ABSORBER

Nitro Gas - Performance			<b>12640GR</b>	2	\$153.00
Foam Cell - Performance			<b>24640FE</b>	2	\$222.00
Foam Cell Pro - Performance			<b>45640FE</b>	2	\$305.00

#### COIL SPRINGS

	Est. Lift	Additional Load			
Medium	40mm	0 - 300kg	<b>LAND011B</b>	1	\$250.00
Heavy	40mm	300kg - GVM	<b>LAND011C</b>	1	\$278.00

### SUSPENSION KIT

Medium - Nitro Gas	<b>LAND009BKG</b>	\$1109.00
Medium - Foam Cell	<b>LAND009BKF</b>	\$1386.00
Medium - Foam Cell Pro	<b>LAND009BKP</b>	\$1718.00
Heavy - Nitro Gas	<b>LAND009CKG</b>	\$1136.00
Heavy - Foam Cell	<b>LAND009CKF</b>	\$1413.00
Heavy - Foam Cell Pro	<b>LAND009CKP</b>	\$1746.00

• Specify front Coil Springs when ordering

### SUSPENSION KIT CONTENTS

Shock Absorbers

Coil Springs

# LDV T60

2.8L Turbo Diesel  
2017+



Product Description

Part No.

Qty  
Req

Retail  
ea Inc GST

## ACCESSORIES TO SUIT LDV T60

### STEEL WINCH BULL BARS

Commercial Deluxe	<b>BBCD068</b>		\$2244.00
Proguard No Loop	<b>BBT068-NL</b>		\$1888.00
Proguard Single Loop Kit	<b>BB068-SL</b>		\$336.00
Proguard Triple Loop Kit	<b>BB068-TL</b>		\$404.00

• Winch with Steel Cable and Roller Fairlead is not suitable - Use Winch with Synthetic Rope and Alloy Hawse only

### DIFF BREATHER KIT

Diff Breather Kit	<b>IDIFFBRE</b>		\$115.00
-------------------	-----------------	--	----------

## SUSPENSION TO SUIT LDV

### FRONT SUSPENSION

#### SHOCK ABSORBER

Nitro Gas Strut - Performance	<b>12745GR</b>	2	\$222.00
Foam Cell Strut - Performance	<b>24745FE</b>	2	\$250.00
Foam Cell Pro Strut - Performance	<b>45745FE</b>	2	\$388.00

• Height adjustable with Ironman 4x4 Strut Trim Packers

#### COIL SPRINGS

	Est. Lift	Additional Load			
Medium	40mm	0 - 50kg	<b>HOLD020A</b>	1	\$250.00
Heavy	40mm	50 - 110kg	<b>HOLD020B</b>	1	\$250.00

#### STRUT MOUNTS

Steel Strut Top	<b>ISST017</b>	2	\$84.00
-----------------	----------------	---	---------

#### TRIM PACKERS

5mm Strut Trim Packer	Nitro Gas / Foam Cell	<b>HILFR05 / HILFR05F</b>	2	\$28.00
10mm Strut Trim Packer	Nitro Gas / Foam Cell	<b>HILFR10 / HILFR10F</b>	2	\$28.00
15mm Strut Trim Packer	Nitro Gas / Foam Cell	<b>HILFR15 / HILFR15F</b>	2	\$28.00

• ONLY Compatible with Ironman 4x4 Struts (except Pro), lift height subject to 2:1 motion ratio. Unnecessary fitment may lift vehicle too high

#### CONTROL ARMS

Pro-Forge Upper Control Arms	<b>UCA041FA</b>	1	\$882.00
------------------------------	-----------------	---	----------



2.8L Turbo Diesel  
2017+

SUSPENSION TO SUIT

LDV T60

Product Description

Part No.

Qty  
Req

Retail  
ea Inc GST

**REAR SUSPENSION**

**SHOCK ABSORBER**

Nitro Gas - Comfort			<b>12636GRC</b>	2	\$153.00
Nitro Gas - Performance			<b>12636GR</b>	2	\$153.00
Nitro Gas - Professional			<b>12636GRP</b>	2	\$153.00
Foam Cell - Comfort			<b>24636FEC</b>	2	\$222.00
Foam Cell - Performance			<b>24636FE</b>	2	\$222.00
Foam Cell - Professional			<b>24636FEP</b>	2	\$222.00
Foam Cell Pro - Comfort			<b>45636FEC</b>	2	\$305.00
Foam Cell Pro - Performance			<b>45636FE</b>	2	\$305.00
Foam Cell Pro - Professional			<b>45636FEP</b>	2	\$305.00

**LEAF SPRINGS**

	Est. Lift	Additional Load			
Medium	45mm	0 - 200kg	<b>HOLD021A</b>	2	\$402.00
Heavy	45mm	200 - 400kg	<b>HOLD021B</b>	2	\$402.00
Extra Heavy	45mm	400kg - 800kg	<b>HOLD021C</b>	2	\$416.00
Super Heavy	45mm	800kg - GVM	<b>HOLD021D</b>	2	\$416.00

**U-BOLTS**

U-Bolt Kit			<b>437UBKL</b>	2	\$42.00
------------	--	--	----------------	---	---------

**POLYURETHANE SPRING BUSHES**

Bush Kit			<b>770UK</b>	1	\$167.00
----------	--	--	--------------	---	----------

**SPACER KIT**

Headlight Bracket Extension Kit			<b>1207K</b>	1	\$28.00
Centre Bearing Spacer Kit			<b>1208K</b>	1	\$28.00

**GREASABLE SHACKLES AND PINS**

Greasable Shackle			<b>1148</b>	2	\$56.00
Non-Greasable Pin			<b>387-1</b>	2	\$28.00

**HELPER SPRINGS**

Add-A-Leaf			<b>ISL6010</b>	1	\$167.00
Load Plus Helper Springs			<b>LP2</b>	1	\$157.00

**SUSPENSION KIT**

Medium - Nitro Gas	<b>HOLD021AKG2</b>	\$2092.00
Medium - Foam Cell	<b>HOLD021AKF2</b>	\$2286.00
Medium - Foam Cell Pro	<b>HOLD021AKP2</b>	\$2729.00
Heavy - Nitro Gas	<b>HOLD021BKG2</b>	\$2092.00
Heavy - Foam Cell	<b>HOLD021BKF2</b>	\$2286.00
Heavy - Foam Cell Pro	<b>HOLD021BKP2</b>	\$2729.00
Extra Heavy - Nitro Gas	<b>HOLD021CKG2</b>	\$2120.00
Extra Heavy - Foam Cell	<b>HOLD021CKF2</b>	\$2314.00
Extra Heavy - Foam Cell Pro	<b>HOLD021CKP2</b>	\$2757.00
Super Heavy - Nitro Gas	<b>HOLD021DKG2</b>	\$2120.00
Super Heavy - Foam Cell	<b>HOLD021DKF2</b>	\$2314.00
Super Heavy - Foam Cell Pro	<b>HOLD021DKP2</b>	\$2757.00

• Specify front Coil Springs when ordering

**SUSPENSION KIT CONTENTS**

Shock Absorbers	Coil Springs	U-Bolts	Headlight Bracket Kit
Strut Shock Absorbers	Leaf Springs	Polyurethane Spring Bushes	





# Mahindra Scorpio

Getaway Pik-Up  
2002 to 2016



Product Description

Part No.

Qty  
Req

Retail  
ea Inc GST

## SUSPENSION TO SUIT MAHINDRA SCORPIO

### FRONT SUSPENSION

#### SHOCK ABSORBER

Nitro Gas - Performance		<b>12087GR</b>	2	\$153.00
-------------------------	--	----------------	---	----------

#### TORSION BAR

Up-rated Torsion Bars		<b>MAH001</b>	1	\$416.00
-----------------------	--	---------------	---	----------

• Minimum 60mm downward suspension travel required after adjustment

### REAR SUSPENSION

#### SHOCK ABSORBER

Nitro Gas - Performance	2002 - 2012	<b>12749GR</b>	2	\$153.00
Nitro Gas - Performance	2012+	<b>12731GR</b>	2	\$153.00

• Check shock absorber specifications, some models can vary

#### LEAF SPRINGS

	Est. Lift	Additional Load		
Medium	40mm	0 - 200kg	<b>MAH002B</b>	2

#### U-BOLTS

U-Bolt Kit		<b>1103UBK</b>	2	\$42.00
------------	--	----------------	---	---------

#### POLYURETHANE SPRING BUSHES

Bush Kit		<b>719UK</b>	1	\$70.00
----------	--	--------------	---	---------

#### GREASABLE SHACKLES AND PINS

Greasable Shackle	Left side	<b>353LH</b>	1	\$70.00
Greasable Shackle	Right side	<b>353RH</b>	1	\$70.00
Greasable Pin		<b>1149</b>	2	\$42.00

#### HELPER SPRINGS

Load Plus Helper Springs		<b>LP4</b>	1	\$157.00
--------------------------	--	------------	---	----------

### SUSPENSION KIT

Medium - Nitro Gas		<b>MAH002BKG</b>		\$1926.00
--------------------	--	------------------	--	-----------

• Check rear shock absorber part number

### SUSPENSION KIT CONTENTS

Shock Absorbers	Torsion Bars	Polyurethane Spring Bushes
Leaf Springs	U-Bolts	



Wagon  
2002 to 2014

# Mahindra Scorpio

Product Description

Part No.

Qty  
Req

Retail  
ea Inc GST

## SUSPENSION TO SUIT MAHINDRA SCORPIO

### FRONT SUSPENSION

#### SHOCK ABSORBER

Nitro Gas - Performance

12087GR

2

\$153.00

#### TORSION BAR

Uprated Torsion Bars

MAH001

1

\$416.00

• Minimum 60mm downward suspension travel required after adjustment

### REAR SUSPENSION

#### SHOCK ABSORBER

Nitro Gas - Performance

12749GR

2

\$153.00

• Check shock absorber specifications, some models can vary

#### COIL SPRINGS

Medium

Est. Lift  
40mm

Additional Load  
0 - 200kg

MAH003B

1

\$264.00

### SUSPENSION KIT

Medium - Nitro Gas

MAH003BKG

\$1289.00

### SUSPENSION KIT CONTENTS

Shock Absorbers

Coil Springs



Unlock your adventure!

for a full range of accessories visit our website

[www.ironman4x4.com](http://www.ironman4x4.com)



## Mazda BT50

6/2020+

Product Description

DATE AVAILABLE

Part No.

Qty  
ReqRetail  
ea Inc GST

## ACCESSORIES TO SUIT MAZDA BT50

**STEEL WINCH BULL BARS**

Commercial Deluxe		<b>BBCD080</b>	\$2284.00
Proguard No Loop		<b>BBT080-NL</b>	\$1888.00
Proguard Single Loop Kit		<b>BB080-SL</b>	\$336.00
Proguard Triple Loop Kit		<b>BB080-TL</b>	\$404.00
Driving Light Patch Loom - Factory LED Headlight models only		<b>IPL074</b>	\$31.00

**STEEL SIDE STEPS AND RAILS**

Side Steps		<b>SS074</b>	\$962.00
Side Steps and Rails	<b>Q4 2021</b>	<b>SSR080</b>	\$1155.00

**TOWING**

Rear Protection Towbar	<b>Q4 2021</b>	<b>RTB080</b>	\$1328.00
Towbar Wiring Loom - Plug and Play		<b>ITBL074</b>	\$445.00

**SNORKEL**

6/2020+	<b>Q1 2022</b>	<b>ISNORKEL080</b>	\$418.00
---------	----------------	--------------------	----------

**PREMIUM UNDERBODY PROTECTION**

Engine Bay and Transmission - Electric Steering Model	<b>Q4 2021</b>	<b>UBP074S</b>	\$712.00
Engine Bay and Transmission - Non-Electric Steering Model		<b>UBP074</b>	\$712.00

**LOCKSAFE DRAWER SYSTEMS**

Twin Drawers - 1300mm		<b>ITD1300</b>	\$1469.00
Single Drawer - 1300mm		<b>ISD1300</b>	\$891.00
Wing Kit - 1300mm*	<b>Q4 2021</b>	<b>ITDW074</b>	\$351.00

\*Designed to suit factory tubs, will not suit ute liner without modification

**CANOPY - ABS PLASTIC (SIDE LIFT UP WINDOWS AND CENTRAL LOCKING REAR DOOR) - FITS 4X4 AND 4X2 DUAL CAB MODELS**

Pre-Primed		<b>CANOPY022-P</b>	\$3238.00*
Marble White (527)		<b>CANOPY022-W</b>	\$3856.00
ABS Canopy Rack Feet		<b>IRRFEETABS14</b>	\$274.00

• See Page 37 and 38 for 1.4m Roof Rack options and pricing.

\* Pre-primed canopies, plus colour coding.

**SLIDE-AWAY ROLL UP HARD TONNEAU COVER**

Electric with Remote Control		<b>ISLIDEAWAY080-E</b>	\$2599.00
------------------------------	--	------------------------	-----------

**SEAT COVER**

Canvas Comfort - Front		<b>ICSC074F</b>	\$401.00
Canvas Comfort - Rear		<b>ICSC074R</b>	\$401.00

**DIFF BREATHER KIT**

Diff Breather Kit		<b>IDIFFBRE</b>	\$115.00
-------------------	--	-----------------	----------

LISTING  
CONTINUED  
OVER THE  
PAGE



Product Description

Part No.

Qty  
Req

Retail  
ea Inc GST

SUSPENSION TO SUIT MAZDA BT50

FRONT SUSPENSION

SHOCK ABSORBER

Nitro Gas Strut - Performance			<b>12845GR</b>	2	\$222.00
Foam Cell Strut - Performance			<b>24845FE</b>	2	\$250.00
Foam Cell Pro Strut - Performance			<b>45845FE</b>	2	\$388.00

• Height adjustable with Ironman 4x4 Strut Trim Packers

COIL SPRINGS

	Est. Lift	Additional Load			
Standard	0mm	0 - 50kg	<b>HOLD020S</b>	1	\$250.00
Light	30mm	0 - 50kg	<b>HOLD020A</b>	1	\$250.00
Medium	40mm	0 - 50kg	<b>HOLD020B</b>	1	\$250.00
Heavy	40mm	50 - 110kg	<b>HOLD020C</b>	1	\$250.00

STRUT MOUNTS

Steel Strut Top			<b>ISST017</b>	2	\$84.00
-----------------	--	--	----------------	---	---------

CONTROL ARMS

Pro-Forge Upper Control Arms			<b>UCA074FA</b>	1	\$882.00
------------------------------	--	--	-----------------	---	----------

TRIM PACKERS

5mm Strut Trim Packer	Nitro Gas / Foam Cell	<b>HILFR05 / HILFR05F</b>	2	\$28.00
10mm Strut Trim Packer	Nitro Gas / Foam Cell	<b>HILFR10 / HILFR10F</b>	2	\$28.00
15mm Strut Trim Packer	Nitro Gas / Foam Cell	<b>HILFR15 / HILFR15F</b>	2	\$28.00

• ONLY Compatible with Ironman 4x4 Struts (except Pro), lift height subject to 2:1 motion ratio. Unnecessary fitment may lift vehicle too high

REAR SUSPENSION

SHOCK ABSORBER

Nitro Gas - Comfort			<b>12698GRC</b>	2	\$153.00
Nitro Gas - Performance			<b>12698GR</b>	2	\$153.00
Nitro Gas - Professional			<b>12698GRP</b>	2	\$153.00
Foam Cell - Comfort			<b>24698FEC</b>	2	\$222.00
Foam Cell - Performance			<b>24698FE</b>	2	\$222.00
Foam Cell - Professional			<b>24698FEP</b>	2	\$222.00
Foam Cell Pro - Comfort			<b>45698FEC</b>	2	\$305.00
Foam Cell Pro - Performance			<b>45698FE</b>	2	\$305.00
Foam Cell Pro - Professional			<b>45698FEP</b>	2	\$305.00

LEAF SPRINGS

	Est. Lift	Additional Load			
Light	30mm	0 - 200kg	<b>HOLD021A</b>	2	\$402.00
Medium	45mm	0 - 300kg	<b>HOLD021B</b>	2	\$402.00
Heavy	45mm	300kg - 600kg	<b>HOLD021C</b>	2	\$416.00
Extra Heavy	45mm	600kg - GVM	<b>HOLD021D</b>	2	\$416.00

U-BOLTS

U-Bolt Kit			<b>437UBKL</b>	2	\$42.00
U-Bolt Kit	Suits HOLD021D		<b>678UBK</b>	2	\$42.00

POLYURETHANE SPRING BUSHES

Bush Kit			<b>770UK</b>	1	\$167.00
----------	--	--	--------------	---	----------

SPACER KIT

Brake Hose Relocation Kit			<b>1152K</b>	1	\$14.00
---------------------------	--	--	--------------	---	---------

GREASABLE SHACKLES AND PINS

Greasable Shackle			<b>1156</b>	2	\$56.00
Non-Greasable Pin			<b>387-1</b>	2	\$28.00

HELPER SPRINGS

Add-A-Leaf			<b>ISL6010</b>	1	\$167.00
------------	--	--	----------------	---	----------





6/2020+

# Mazda BT50

Product Description

Part No.

Qty  
Req

Retail  
ea Inc GST

### SUSPENSION KIT

Light - Nitro Gas	HOLD021AKG3	\$2064.00
Light - Foam Cell	HOLD021AKF3	\$2258.00
Light - Foam Cell Pro	HOLD021AKP3	\$2702.00
Medium - Nitro Gas	HOLD021BKG3	\$2064.00
Medium - Foam Cell	HOLD021BKF3	\$2258.00
Medium - Foam Cell Pro	HOLD021BKP3	\$2702.00
Heavy - Nitro Gas	HOLD021CKG3	\$2092.00
Heavy - Foam Cell	HOLD021CKF3	\$2286.00
Heavy - Foam Cell Pro	HOLD021CKP3	\$2729.00
Extra Heavy - Nitro Gas	HOLD021DKG3	\$2092.00
Extra Heavy - Foam Cell	HOLD021DKF3	\$2286.00
Extra Heavy - Foam Cell Pro	HOLD021DKP3	\$2729.00

• Specify front Coil Springs when ordering

### SUSPENSION KIT CONTENTS

Shock Absorbers	Coil Springs	Polyurethane Spring Bushes	Brake Hose Relocation Kit
Strut Shock Absorbers	Leaf Springs	U-Bolts	



OPTIONS AVAILABLE FOR THIS VEHICLE - SEE PAGE 383

# Mazda BT50

2012 to 5/2020  
Includes 5/2018 (Facelift)



Product Description

Part No.

Qty  
Req

Retail  
ea Inc GST

## ACCESSORIES TO SUIT MAZDA BT50

### STEEL WINCH BULL BARS

Commercial	<b>BBC039</b>	\$1648.00
Commercial Deluxe	<b>BBCD039</b>	\$2244.00
Proguard No Loop	<b>BBT039-NL</b>	\$1855.00
Proguard Single Loop Kit	<b>BB039-SL</b>	\$336.00
Proguard Triple Loop Kit	<b>BB039-TL</b>	\$404.00

• Can also be fitted to both 2WD and 4WD models. Note: Can use BB054-SL

### STEEL SIDE STEPS AND RAILS - FITS DUAL CAB MODELS ONLY

Side Steps	<b>SS039</b>	\$962.00
Side Steps Rails	<b>SSR039</b>	\$1155.00

### TOWING

Class 4 Towbar - Compatible with Factory Rear Bumper	<b>TB066</b>	\$581.00
Rear Protection Towbar - Full Rear Bumper Replacement	<b>RTB066</b>	\$1328.00
Rear Protection Towbar Plates (Pair)	<b>RTBPLATE001</b>	\$146.00
Towbar Wiring Loom - Plug and Play	<b>ITBL039</b>	\$366.00

### RECOVERY POINTS - IRONMAN 4X4 BULL BAR ONLY

Recovery Points - 5000kg Rating (Pair)	<b>IRP054</b>	\$325.00
--	---------------	----------

### BATTERY TRAY - DUAL CAB ONLY

Suits 10" Battery	<b>IBTRAY054</b>	\$192.00
-------------------	------------------	----------

### EXHAUST SYSTEM

3" Exhaust Upgrade - DPF Back (2016-2020 only) - <i>While Stocks Last</i>	<b>IEX039</b>	\$770.00
---	---------------	----------

### LONG RANGE FUEL TANK

140L* - Fits 3.2L Diesel only	<b>TANK007</b>	\$1129.00
-------------------------------	----------------	-----------

\* Usable volume may differ to the stated tank capacity

### PREMIUM UNDERBODY PROTECTION

Engine Bay and Transmission	<b>UBP054</b>	\$748.00
Engine Bay and Transmission - DPF Models (Retains factory transmission plate)	<b>UBP055</b>	\$526.00

### UNDERBODY PROTECTION

Engine Bay and Transmission - <i>While Stocks Last</i>	<b>IUP014K</b>	\$494.00
Fuel Tank - <i>While Stocks Last</i>	<b>IUP014F</b>	\$296.00

• Fuel tank protection plates are not compatible with long range fuel tanks.

### LOCKSAFE DRAWER SYSTEMS

Twin Drawers - 1300mm	<b>ITD1300</b>	\$1469.00
Single Drawer - 1300mm	<b>ISD1300</b>	\$891.00
Wing Kit - 1300mm*	<b>ITDW037</b>	\$351.00

\*Designed to suit factory tubs, will not suit ute liner without modification.

## Mazda BT50

2012 to 5/2020  
Includes 5/2018 (Facelift)



Product Description	Part No.	Qty Req	Retail ea Inc GST
<b>CANOPY - ABS PLASTIC (SIDE LIFT UP WINDOWS AND CENTRAL LOCKING REAR DOOR) - FITS 4X4 AND 4X2 DUAL CAB MODELS</b>			
Pre-Primed	CANOPY010-P †		\$3238.00*
Cool White (WVA) (A2W)	CANOPY010-CW		\$3856.00
Aurora Blue (WVD) (39A)	CANOPY010-AB		\$3856.00
Highlight Silver (18G)	CANOPY010-S		\$3856.00
Winning Blue (WVW)	CANOPY010-WB		\$3856.00
Magnetic Grey (WVQ)	CANOPY010-M †		\$3856.00
True Red (SWH)	CANOPY010-TR		\$3856.00
Meteor Grey (42A) (SWT)	CANOPY010-G †		\$3856.00
Titanium Flash (42A)	CANOPY018-TF		\$3856.00
Frozen White (WVZ)	CANOPY010-FW †		\$3856.00
Metropolitan Grey (WVT) (36C)	CANOPY010-MG		\$3856.00
Aluminium Metallic (SWR) (38P)	CANOPY010-AM		\$3856.00
Ingot Silver (WVR)	CANOPY010-IS †		\$2453.82
Shadow Black (UO)	CANOPY010-SB †		\$2453.82
Blue Lightning (SW3)	CANOPY010-BL †		\$2453.82
Arctic White (SWU)	CANOPY010-AW †		\$2453.82
Jet Black Mica (41W)	CANOPY018-B		\$3856.00
ABS Canopy Rack Feet	IRRFEETABS14		\$274.00
<ul style="list-style-type: none"> <li>• Includes tub strengthening bracket (CANOPY010 BRACKET)</li> <li>• Colour code and build date must be confirmed for Aluminium Metallic Canopies (CANOPY010-AM)</li> <li>• See Page 37 and 38 for 1.4m Roof Rack options and pricing.</li> </ul>			
* Pre-primed canopies, plus colour coding. († With central locking)			
<b>CANOPY - PINNACLE SMOOTH FINISH FIBREGLASS (SIDE LIFT UP WINDOWS AND CENTRAL LOCKING REAR DOOR) - FITS 4X4 AND 4X2 DUAL CAB MODELS</b>			
Pre-Primed	CANFIBRE054-P		\$2899.00*
Frozen White (WVZ)	CANFIBRE054-FW		\$3399.00
Magnetic Grey (WVQ)	CANFIBRE054-M		\$3399.00
Winning Blue (WVW)	CANFIBRE054-WB		\$3399.00
Ingot Silver (WVR)	CANFIBRE054-IS		\$3399.00
Shadow Black (UO)	CANFIBRE054-SB		\$3399.00
* Pre-primed canopies, plus colour coding.			
<b>CANOPY - PINNACLE 2 SMOOTH FINISH FIBREGLASS (SIDE LIFT UP WINDOWS AND CENTRAL LOCKING REAR DOOR) - FITS 4X4 AND 4X2 DUAL CAB MODELS</b>			
Pre-Primed	ICANOPY054-P		\$2899.00*
Aluminium Metallic (SWR) (38P)	ICANOPY054-AM		\$3399.00
Arctic White (SWU)	ICANOPY054-AW		\$3399.00
Blue Lightning (SW3)	ICANOPY054-BL		\$3399.00
Frozen White (WVZ)	ICANOPY054-FW		\$3399.00
Meteor Grey (42A) (SWT)	ICANOPY054-G		\$3399.00
Shadow Black (UO)	ICANOPY054-SB		\$3399.00
<b>TUB STRENGTHENING BRACKET</b>			
To suit all Canopies - (Must be fitted)	CANOPY010 BRACKET		\$51.00
<b>SEAT COVER</b>			
2012-2015 Canvas Comfort - Front	ICSC038F		\$401.00
2012-2015 Canvas Comfort - Rear	ICSC038R		\$401.00
2016+ Canvas Comfort - Front	ICSC054F		\$401.00
2016+ Canvas Comfort - Rear	ICSC055R		\$401.00
<b>DIFF BREATHER KIT</b>			
Diff Breather Kit	IDIFFBRE		\$115.00

LISTING  
CONTINUED  
OVER THE  
PAGE



Product Description

Part No.

Qty  
Req

Retail  
ea Inc GST

## SUSPENSION TO SUIT MAZDA BT50

### FRONT SUSPENSION

#### SHOCK ABSORBER

Nitro Gas Strut - Performance			<b>12727GR</b>	2	\$222.00
Foam Cell Strut - Performance			<b>24727FE</b>	2	\$250.00
Foam Cell Pro Strut - Performance			<b>45727FE</b>	2	\$388.00

• Height adjustable with Ironman 4x4 Strut Trim Packers

#### COIL SPRINGS

	Est. Lift	Additional Load			
Standard	0mm	0 - 50kg	<b>FOR001S</b>	1	\$250.00
Light	35mm	0 - 50kg	<b>FOR001A</b>	1	\$250.00
Medium	40mm	0 - 50kg	<b>FOR001B</b>	1	\$250.00
Heavy	45mm	50 - 110kg	<b>FOR001C</b>	1	\$250.00

#### STRUT MOUNTS

Steel Strut Top			<b>ISST014</b>	2	\$84.00
-----------------	--	--	----------------	---	---------

#### TRIM PACKERS

5mm Strut Trim Packer	Nitro Gas / Foam Cell	<b>HILFR05 / HILFR05F</b>	2	\$28.00
10mm Strut Trim Packer	Nitro Gas / Foam Cell	<b>HILFR10 / HILFR10F</b>	2	\$28.00
15mm Strut Trim Packer	Nitro Gas / Foam Cell	<b>HILFR15 / HILFR15F</b>	2	\$28.00

• ONLY Compatible with Ironman 4x4 Struts (except Pro), lift height subject to 2:1 motion ratio. Unnecessary fitment may lift vehicle too high

#### CONTROL ARMS

Pro-Forge Upper Control Arms		<b>UCA054FA</b>	1	\$882.00
------------------------------	--	-----------------	---	----------

#### SPACER KIT

Sway Bar Relocation Kit		<b>1203K</b>	1	\$97.00
-------------------------	--	--------------	---	---------

### REAR SUSPENSION

#### SHOCK ABSORBER

Nitro Gas - Comfort			<b>12095GRC</b>	2	\$153.00
Nitro Gas - Performance			<b>12095GR</b>	2	\$153.00
Foam Cell - Comfort			<b>24095FEC</b>	2	\$222.00
Foam Cell - Performance			<b>24095FE</b>	2	\$222.00
Foam Cell - Professional			<b>24095FEP</b>	2	\$222.00
Foam Cell Pro - Comfort			<b>45095FEC</b>	2	\$305.00
Foam Cell Pro - Performance			<b>45095FE</b>	2	\$305.00
Foam Cell Pro - Professional			<b>45095FEP</b>	2	\$305.00

#### LEAF SPRINGS

	Est. Lift	Additional Load			
Light	40mm	0 - 200kg	<b>FOR002A</b>	2	\$375.00
Medium	45mm	0 - 300kg	<b>FOR002B</b>	2	\$375.00
Heavy	45mm	300kg - GVM	<b>FOR002C</b>	2	\$402.00

• Possible driveline vibration may occur due to increased ride height, use 1194K to reduce vibration to satisfactory level

#### U-BOLTS

U-Bolt Kit		<b>417UBK</b>	2	\$42.00
------------	--	---------------	---	---------

#### POLYURETHANE SPRING BUSHES

Bush Kit		<b>1193UK</b>	1	\$167.00
----------	--	---------------	---	----------

#### DRIVELINE SPACERS

Centre Bearing Spacer Kit		<b>1194K</b>	1	\$42.00
---------------------------	--	--------------	---	---------

#### GREASABLE SHACKLES AND PINS

Greasable Shackle		<b>1147</b>	2	\$56.00
Non-Greasable Pin		<b>387-1</b>	2	\$28.00

#### HELPER SPRINGS

Load Plus Helper Springs		<b>LP3</b>	1	\$157.00
Add-A-Leaf		<b>ISL6010</b>	1	\$167.00



2011 to 5/2020

**SUSPENSION TO SUIT**

# Mazda BT50

Product Description

Part No.

Qty  
Req

Retail  
ea Inc GST

## SUSPENSION KIT

Light - Nitro Gas	<b>FOR001AKG</b>	\$2037.00
Light - Foam Cell	<b>FOR001AKF</b>	\$2231.00
Light - Foam Cell Pro	<b>FOR001AKP</b>	\$2674.00
Medium - Nitro Gas	<b>FOR001BKG</b>	\$2037.00
Medium - Foam Cell	<b>FOR001BKF</b>	\$2231.00
Medium - Foam Cell Pro	<b>FOR001BKP</b>	\$2674.00
Heavy - Nitro Gas	<b>FOR001CKG</b>	\$2092.00
Heavy - Foam Cell	<b>FOR001CKF</b>	\$2286.00
Heavy - Foam Cell Pro	<b>FOR001CKP</b>	\$2729.00

• Specify front Coil Springs when ordering

• Possible driveline vibration may occur due to increased ride height, use 1194K to reduce vibration to satisfactory level.

## SUSPENSION KIT CONTENTS

Shock Absorbers	Coil Springs	Polyurethane Spring Bushes	Centre Bearing Spacer Kit
Strut Shock Absorbers	Leaf Springs	U-Bolts	



# Mazda BT50

J97M  
2006 to 2011



Product Description

Part No.

Qty  
Req

Retail  
ea Inc GST

## ACCESSORIES TO SUIT MAZDA BT50

### STEEL WINCH BULL BARS

Commercial Deluxe Protector	BBCD024	\$2244.00
	BBT024	\$2271.00

• Can also be fitted to both 2WD and 4WD models.

### STEEL SIDE STEPS AND RAILS - FITS DUAL CAB MODELS ONLY

Side Steps	SS009	\$962.00
Side Steps and Rails	SSR007	\$1155.00

### SNORKEL

3.0L TDi Diesel	ISNORKEL024	\$418.00
-----------------	-------------	----------

### EXHAUST SYSTEM

BigBore BT50 (Automatic Transmission) - Diesel Only - <i>While Stocks Last</i>	IEXHAUST014	\$1301.00
BigBore BT50 (Manual Transmission) - Diesel Only - <i>While Stocks Last</i>	IEXHAUST015	\$1301.00

### LONG RANGE FUEL TANK

122L* - Fits Dual and Single Cab only <i>* Usable volume may differ to the stated tank capacity</i>	TANK006	\$1129.00
--	---------	-----------

### UNDERBODY PROTECTION

Engine Bay and Transmission - <i>While Stocks Last</i>	IUP008K	\$437.00
--	---------	----------

### LOCKSAFE DRAWER SYSTEMS

Twin Drawers - 1300mm	ITD1300	\$1469.00
Single Drawer - 1300mm	ISD1300	\$891.00

### CANOPY - ABS PLASTIC (SIDE LIFT UP WINDOWS) - FITS 4X4 AND 4X2 DUAL CAB MODELS

Pre-Primed - <i>While Stocks Last</i>	CANOPY004-P	\$3238.00*
White (A2W) - <i>While Stocks Last</i>	CANOPY004-W	\$3856.00

*\* Pre-primed canopies, plus colour coding.*

### DIFF BREATHER KIT

Diff Breather Kit	IDIFFBRE	\$115.00
-------------------	----------	----------



## Mazda BT50

2006 to 2011

## Product Description

## Part No.

Qty  
ReqRetail  
ea Inc GST

## SUSPENSION TO SUIT MAZDA BT50

## FRONT SUSPENSION

## SHOCK ABSORBER

Nitro Gas - Performance		<b>12667GR</b>	2	\$153.00
Foam Cell - Performance		<b>24667FE</b>	2	\$222.00
Foam Cell Pro - Performance		<b>45667FE</b>	2	\$305.00

## TORSION BAR

Uprated Torsion Bars	Duratorq Engine	<b>MAZDA014</b>	1	\$416.00
Uprated Torsion Bars	2.5L WLT Engine	<b>MAZDA005</b>	1	\$416.00

• MAZDA014 is 1024mm in length, used on most vehicles. Vehicles with 2.5L WLT Engine use MAZDA005 (924mm) Torsion Bar

• Minimum 60mm downward suspension travel required after adjustment

## REAR SUSPENSION

## SHOCK ABSORBER

Nitro Gas - Comfort		<b>12095GRC</b>	2	\$153.00
Nitro Gas - Performance		<b>12095GR</b>	2	\$153.00
Foam Cell - Comfort		<b>24095FEC</b>	2	\$222.00
Foam Cell - Performance		<b>24095FE</b>	2	\$222.00
Foam Cell - Professional		<b>24095FEP</b>	2	\$222.00
Foam Cell Pro - Comfort		<b>45095FEC</b>	2	\$305.00
Foam Cell Pro - Performance		<b>45095FE</b>	2	\$305.00
Foam Cell Pro - Professional		<b>45095FEP</b>	2	\$305.00

## LEAF SPRINGS

	Est. Lift	Additional Load			
Light	40mm	0 - 100kg	<b>MAZDA041A</b>	2	\$375.00
Medium	40mm	0 - 200kg	<b>MAZDA041B</b>	2	\$375.00
Heavy	40mm	200 - 400kg	<b>MAZDA041C</b>	2	\$402.00
Extra Heavy	40mm	400kg - GVM	<b>MAZDA041D</b>	2	\$402.00

## U-BOLTS

U-Bolt Kit		<b>417UBK</b>	2	\$42.00
------------	--	---------------	---	---------

## POLYURETHANE SPRING BUSHES

Bush Kit		<b>759UK</b>	1	\$84.00
----------	--	--------------	---	---------

## GREASABLE SHACKLES AND PINS

Greasable Shackle		<b>386-1</b>	2	\$56.00
-------------------	--	--------------	---	---------

## HELPER SPRINGS

Load Plus Helper Springs		<b>LP3</b>	1	\$157.00
Add-A-Leaf		<b>ISL6010</b>	1	\$167.00

## SUSPENSION KIT

Light - Nitro Gas	<b>MAZDA041AKG</b>	\$1940.00
Light - Foam Cell	<b>MAZDA041AKF</b>	\$2217.00
Light - Foam Cell Pro	<b>MAZDA041AKP</b>	\$2549.00
Medium - Nitro Gas	<b>MAZDA041BKG</b>	\$1940.00
Medium - Foam Cell	<b>MAZDA041BKF</b>	\$2217.00
Medium - Foam Cell Pro	<b>MAZDA041BKP</b>	\$2549.00
Heavy - Nitro Gas	<b>MAZDA041CKG</b>	\$1995.00
Heavy - Foam Cell	<b>MAZDA041CKF</b>	\$2272.00
Heavy - Foam Cell Pro	<b>MAZDA041CKP</b>	\$2605.00
Extra Heavy - Nitro Gas	<b>MAZDA041DKG</b>	\$1995.00
Extra Heavy - Foam Cell	<b>MAZDA041DKF</b>	\$2272.00
Extra Heavy - Foam Cell Pro	<b>MAZDA041DKP</b>	\$2605.00

• Check Torsion Bar length before ordering

## SUSPENSION KIT CONTENTS

Shock Absorbers

Torsion Bars

Polyurethane Spring Bushes

Leaf Springs

U-Bolts



an adventure is worth sharing!



for a full range of accessories visit our website

[www.ironman4x4.com](http://www.ironman4x4.com)



## Mazda B Series

Bravo  
1987 to 2006

## Product Description

## Part No.

Qty  
ReqRetail  
ea Inc GST

## SUSPENSION TO SUIT MAZDA B SERIES

## FRONT SUSPENSION

## SHOCK ABSORBER

Nitro Gas - Performance	12667GR	2	\$153.00
Foam Cell - Performance	24667FE	2	\$222.00
Foam Cell Pro - Performance	45667FE	2	\$305.00

## TORSION BAR

Uprated Torsion Bars	MAZDA005	1	\$416.00
----------------------	----------	---	----------

• Minimum 60mm downward suspension travel required after adjustment

## REAR SUSPENSION

## SHOCK ABSORBER

Nitro Gas - Comfort	12095GRC	2	\$153.00
Nitro Gas - Performance	12095GR	2	\$153.00
Foam Cell - Comfort	24095FEC	2	\$222.00
Foam Cell - Performance	24095FE	2	\$222.00
Foam Cell - Professional	24095FEP	2	\$222.00
Foam Cell Pro - Comfort	45095FEC	2	\$305.00
Foam Cell Pro - Performance	45095FE	2	\$305.00
Foam Cell Pro - Professional	45095FEP	2	\$305.00

## LEAF SPRINGS

	Est. Lift	Additional Load			
Light	40mm	0 - 100kg	MAZDA006A	2	\$375.00
Medium	40mm	0 - 200kg	MAZDA006B	2	\$375.00
Heavy	40mm	200 - 400kg	MAZDA006C	2	\$375.00
Extra Heavy	40mm	400kg - GVM	MAZDA006D	2	\$402.00

## U-BOLTS

U-Bolt Kit	415UBK	2	\$42.00
------------	--------	---	---------

## POLYURETHANE SPRING BUSHES

Bush Kit	756UK	1	\$84.00
----------	-------	---	---------

## GREASABLE SHACKLES AND PINS

Greasable Shackle	386-1	2	\$56.00
Greasable Pin	794	2	\$42.00

## HELPER SPRINGS

Load Plus Helper Springs	LP3	1	\$157.00
Add-A-Leaf	ISL6010	1	\$167.00

## SUSPENSION KIT

Light - Nitro Gas	MAZDA006AKG	\$1940.00
Light - Foam Cell	MAZDA006AKF	\$2217.00
Light - Foam Cell Pro	MAZDA006AKP	\$2549.00
Medium - Nitro Gas	MAZDA006BKG	\$1940.00
Medium - Foam Cell	MAZDA006BKF	\$2217.00
Medium - Foam Cell Pro	MAZDA006BKP	\$2549.00
Heavy - Nitro Gas	MAZDA006CKG	\$1940.00
Heavy - Foam Cell	MAZDA006CKF	\$2217.00
Heavy - Foam Cell Pro	MAZDA006CKP	\$2549.00
Extra Heavy - Nitro Gas	MAZDA006DKG	\$1995.00
Extra Heavy - Foam Cell	MAZDA006DKF	\$2272.00
Extra Heavy - Foam Cell Pro	MAZDA006DKP	\$2605.00

## SUSPENSION KIT CONTENTS

Shock Absorbers  
Leaf SpringsTorsion Bars  
U-Bolts

Polyurethane Spring Bushes

# Mercedes-Benz G-Wagen

W460, W461, W463  
1979+



Product Description

Part No.

Qty  
Req

Retail  
ea Inc GST

## SUSPENSION TO SUIT MERCEDES-BENZ G-WAGEN

### FRONT SUSPENSION

#### SHOCK ABSORBER

Nitro Gas - Performance			<b>12811GR</b>	2	\$153.00
Foam Cell - Performance			<b>24811FE</b>	2	\$222.00

#### COIL SPRINGS

	Est. Lift	Additional Load			
Medium	45mm	0 - 50kg	<b>MERC020B</b>	1	\$270.00

### REAR SUSPENSION

#### SHOCK ABSORBER

Nitro Gas - Performance			<b>12812GR</b>	2	\$153.00
Foam Cell - Performance			<b>24812FE</b>	2	\$222.00

#### COIL SPRINGS

	Est. Lift	Additional Load			
Medium	45mm	0 - 300kg	<b>MERC021B</b>	1	\$270.00

### SUSPENSION KIT

Medium - Nitro Gas	<b>MERC021BKG</b>	\$1192.00
Medium - Foam Cell	<b>MERC021BKF</b>	\$1469.00

### SUSPENSION KIT CONTENTS

Shock Absorbers

Coil Springs





G55 AMG

# Mercedes-Benz G-Wagen

Product Description

Part No.

Qty  
Req

Retail  
ea Inc GST

## SUSPENSION TO SUIT MERCEDES-BENZ G-WAGEN

### FRONT SUSPENSION

**SHOCK ABSORBER**

Foam Cell - Performance

**24788FE**

2

\$222.00

**COIL SPRINGS**

Est. Lift

Additional Load

Medium

45mm

0 - 50kg

**MERC015B**

1

\$291.00

### REAR SUSPENSION

**SHOCK ABSORBER**

Foam Cell - Performance

**24789FE**

2

\$222.00

**COIL SPRINGS**

Est. Lift

Additional Load

Medium

45mm

0 - 300kg

**MERC016B**

1

\$291.00

### SUSPENSION KIT

Medium - Foam Cell

**MERC015BKF**

\$1469.00

### SUSPENSION KIT CONTENTS

Shock Absorbers

Coil Springs



# Mercedes-Benz Unimog

UL1700, 2450, U5000  
1300, 1550, U4000



Product Description

Part No.

Qty  
Req

Retail  
ea Inc GST

## SUSPENSION TO SUIT MERCEDES-BENZ UNIMOG

### FRONT SUSPENSION

#### SHOCK ABSORBER

Foam Cell Pro - Performance	10 Bolt Axle Models	<b>45802FE</b>	2	\$305.00
Foam Cell Pro - Performance	6 Bolt Axle Models	<b>45803FE</b>	2	\$305.00

### REAR SUSPENSION

#### SHOCK ABSORBER

Foam Cell Pro - Performance	10 Bolt Axle Models	<b>45802FE</b>	2	\$305.00
Foam Cell Pro - Performance	6 Bolt Axle Models	<b>45803FE</b>	2	\$305.00



4 Cyl Models  
2017 to 5/2020

# Mercedes-Benz X-Class

Product Description

Part No.

Qty  
ReqRetail  
ea Inc GST

## SUSPENSION TO SUIT MERCEDES-BENZ X-CLASS

### FRONT SUSPENSION

#### SHOCK ABSORBER

Nitro Gas Strut - Performance			<b>12716GR</b>	2	\$222.00
Foam Cell Strut - Performance			<b>24716FE</b>	2	\$250.00
Foam Cell Pro Strut - Performance			<b>45716FE</b>	2	\$388.00

- Foam Cell Pro contains a single adjusting ring for driveshaft clearance
- Height adjustable with Ironman 4x4 Strut Trim Packers

#### COIL SPRINGS

	Est. Lift	Additional Load			
Standard Height	0mm	0 - 50kg	<b>NISS040A</b>	1	\$250.00
Light	20mm	0 - 50kg	<b>NISS040B</b>	1	\$250.00
Medium	35mm	0 - 80kg	<b>NISS040C</b>	1	\$250.00
Heavy	40mm	50 - 110kg	<b>NISS040D</b>	1	\$250.00

#### STRUT MOUNTS

Steel Strut Top			<b>ISST007</b>	2	\$84.00
-----------------	--	--	----------------	---	---------

#### TRIM PACKERS

5mm Strut Trim Packer	Nitro Gas / Foam Cell	<b>HILFR05 / HILFR05F</b>	2	\$28.00
10mm Strut Trim Packer	Nitro Gas / Foam Cell	<b>HILFR10 / HILFR10F</b>	2	\$28.00
15mm Strut Trim Packer	Nitro Gas / Foam Cell	<b>HILFR15 / HILFR15F</b>	2	\$28.00

- ONLY Compatible with Ironman 4x4 Struts (except Pro), lift height subject to 2:1 motion ratio. Unnecessary fitment may lift vehicle too high

### REAR SUSPENSION

#### SHOCK ABSORBER

Nitro Gas - Performance			<b>12728GR</b>	2	\$153.00
Foam Cell - Performance			<b>24728FE</b>	2	\$222.00
Foam Cell - Professional			<b>24728FEP</b>	2	\$222.00
Foam Cell Pro - Comfort			<b>45728FEC</b>	2	\$305.00
Foam Cell Pro - Performance			<b>45728FE</b>	2	\$305.00
Foam Cell Pro - Professional			<b>45728FEP</b>	2	\$305.00

#### COIL SPRINGS

	Est. Lift	Additional Load			
Light	20mm	0 - 200kg	<b>NISS058A</b>	1	\$250.00
Medium	40mm	0 - 300kg	<b>NISS058B</b>	1	\$250.00
Heavy	40mm	300kg - 600kg	<b>NISS058C</b>	1	\$250.00
Extra Heavy	45mm	600kg - GVM	<b>NISS058D</b>	1	\$250.00

#### COIL SPACER

Polyurethane 20mm			<b>NAVR20</b>	2	\$42.00
-------------------	--	--	---------------	---	---------

#### SPACER KIT

Sway Bar and Headlight Bracket Extension Kit			<b>1204K</b>	1	\$97.00
--	--	--	--------------	---	---------

### SUSPENSION KIT

Medium - Nitro Gas	<b>NISS058BKG</b>	\$1344.00
Medium - Foam Cell	<b>NISS058BKF</b>	\$1538.00
Medium - Foam Cell Pro	<b>NISS058BKP</b>	\$1981.00
Heavy - Nitro Gas	<b>NISS058CKG</b>	\$1344.00
Heavy - Foam Cell	<b>NISS058CKF</b>	\$1538.00
Heavy - Foam Cell Pro	<b>NISS058CKP</b>	\$1981.00
Extra Heavy - Nitro Gas	<b>NISS058DKG</b>	\$1344.00
Extra Heavy - Foam Cell	<b>NISS058DKF</b>	\$1538.00
Extra Heavy - Foam Cell Pro	<b>NISS058DKP</b>	\$1981.00

- Specify front Coil Springs when ordering

### SUSPENSION KIT CONTENTS

Shock Absorbers	Coil Springs
Strut Shock Absorbers	Sway Bar and Headlight Bracket Kit

# Mitsubishi Pajero Sport

7/2019+



Product Description

DATE AVAILABLE

Part No.

Qty  
Req

Retail  
ea Inc GST

## ACCESSORIES TO SUIT MITSUBISHI PAJERO SPORT

### STEEL WINCH BULL BARS

Commercial Deluxe	Q1 2022	BBCD079	\$2284.00
Proguard No Loop	Q1 2022	BBT079-NL	\$1888.00
Proguard Single Loop Kit	Q1 2022	BB079-SL	\$336.00
Proguard Triple Loop Kit	Q1 2022	BB079-TL	\$404.00

• Winch with Steel Cable and Roller Fairlead is not suitable - Use Winch with Synthetic Rope and Alloy Hawse only

### STEEL SIDE STEPS AND RAILS

Side Steps	Q1 2022	SS079	\$959.00
------------	---------	-------	----------

### RECOVERY POINTS - IRONMAN 4X4 BULL BAR ONLY

Recovery Points - 5000kg Rating (Pair)		IRP059	\$325.00
--	--	--------	----------

### PREMIUM UNDERBODY PROTECTION

Engine Bay and Transmission		UBP050	\$748.00
-----------------------------	--	--------	----------

### SEAT COVER

Front		ICSC059F	\$401.00
Rear		ICSC059R	\$401.00

### DIFF BREATHER KIT

Diff Breather Kit		IDIFFBRE	\$115.00
-------------------	--	----------	----------





7/2019+

# Mitsubishi Pajero Sport

Product Description

Part No.

Qty  
ReqRetail  
ea Inc GST

## SUSPENSION TO SUIT MITSUBISHI PAJERO SPORT

### FRONT SUSPENSION

#### SHOCK ABSORBER

Nitro Gas Strut - Performance <sup>1</sup>			<b>12715GR</b>	2	\$222.00
Foam Cell Strut - Performance <sup>1</sup>			<b>24715FE</b>	2	\$250.00
Foam Cell Pro Strut - Performance* (SEE NOTE)			<b>45715FE</b>	2	\$388.00

\*NOTE: MANDATORY FITMENT of UCA050FA and MITS045B /C Coil Springs with 45715FE

<sup>1</sup> Height adjustable with Ironman 4x4 Strut Trim Packers

#### COIL SPRINGS

	Est. Lift	Additional Load			
Medium	15mm	0 - 50kg	<b>MITSO40B</b>	1	\$250.00
Medium* (SEE NOTE)	50mm	0 - 50kg	<b>MITSO45B *</b>	1	\$250.00
Heavy	30mm	50 - 110kg	<b>MITSO40C</b>	1	\$250.00
Heavy* (SEE NOTE)	50mm	50 - 110kg	<b>MITSO45C *</b>	1	\$250.00

\*NOTE: MANDATORY FITMENT of UCA050FA and 45715FE with (MITSO45B /C) Coil Springs

#### STRUT MOUNTS

Steel Strut Top			<b>ISS010</b>	2	\$97.00
-----------------	--	--	---------------	---	---------

#### TRIM PACKERS

5mm Strut Trim Packer	Nitro Gas / Foam Cell	<b>HILFR05 / HILFR05F</b>	2	\$28.00
10mm Strut Trim Packer	Nitro Gas / Foam Cell	<b>HILFR10 / HILFR10F</b>	2	\$28.00
15mm Strut Trim Packer	Nitro Gas / Foam Cell	<b>HILFR15 / HILFR15F</b>	2	\$28.00

• ONLY Compatible with Ironman 4x4 Struts, lift height subject to 2:1 motion ratio. Unnecessary fitment may lift vehicle too high

#### CONTROL ARMS

Pro-Forge Upper Control Arms			<b>UCA050FA</b>	1	\$882.00
------------------------------	--	--	-----------------	---	----------

### REAR SUSPENSION

#### SHOCK ABSORBER

Nitro Gas - Performance			<b>12645GRS</b>	2	\$153.00
Foam Cell - Performance			<b>24645FES</b>	2	\$222.00

#### COIL SPRINGS

	Est. Lift	Additional Load			
Light	15mm	0 - 200kg	<b>MITSO42A</b>	1	\$250.00
Medium	30mm	0 - 250kg	<b>MITSO42B</b>	1	\$250.00
Medium - with Accessories	40mm	250-500kg	<b>MITSO20B</b>	1	\$250.00
Heavy	40mm	300kg - GVM	<b>MITSO42C</b>	1	\$250.00

• Check LHS rear coil captivity when lowering to ground

### SUSPENSION KIT

Medium - Nitro Gas	<b>MITSO42BKG1</b>	\$1247.00
Medium - Foam Cell	<b>MITSO42BKF1</b>	\$1441.00
Heavy - Nitro Gas	<b>MITSO42CKG1</b>	\$1247.00
Heavy - Foam Cell	<b>MITSO42CKF1</b>	\$1441.00

• Specify Front Coil Springs when ordering

• Please note limited lift height, due to restrictions in vehicle design.

### SUSPENSION KIT CONTENTS

Shock Absorbers

Strut Shock Absorbers

Coil Springs



# Mitsubishi Pajero Sport

11/2016 to 6/2019



Product Description

Part No.

Qty  
Req

Retail  
ea Inc GST

## ACCESSORIES TO SUIT MITSUBISHI PAJERO SPORT

### STEEL WINCH BULL BARS

Commercial Deluxe\* - Suits GLX and GLS

**BBCD059**

\$2284.00

Exceed Kit - Required for Exceed model

**BB059-EXCEED KIT**

\$135.00

Proguard No Loop

**BBT059-NL**

\$1888.00

Proguard Single Loop Kit

**BB059-SL**

\$336.00

Proguard Triple Loop Kit

**BB059-TL**

\$404.00

*\* Winch with Steel Cable and Roller Fairlead is not suitable - Use Winch with Synthetic Rope and Alloy Hawse only*

*\* Do not fit winch control box in front of Mitsubishi Badge for vehicles with Radar.*

### STEEL SIDE STEPS AND RAILS - BODY MOUNT ONLY DUE TO ELECTRIC HANDBRAKE

Side Steps

**SS059**

\$962.00

### RECOVERY POINTS - IRONMAN 4X4 BULL BAR ONLY

Recovery Points - 5000kg Rating (Pair)

**IRP059**

\$325.00

### SEAT COVER

Canvas Comfort - Front

**ICSC059F**

\$401.00

Canvas Comfort - Rear

**ICSC059R**

\$401.00

### DIFF BREATHER KIT

Diff Breather Kit

**IDIFFBRE**

\$115.00





2.4L Mivec  
2015 to 6/2019

# Mitsubishi Pajero Sport

Product Description

Part No.

Qty  
Req

Retail  
ea Inc GST

## SUSPENSION TO SUIT MITSUBISHI PAJERO SPORT

### FRONT SUSPENSION

#### SHOCK ABSORBER

Nitro Gas Strut - Performance <sup>1</sup>	<b>12715GR</b>	2	\$222.00
Foam Cell Strut - Performance <sup>1</sup>	<b>24715FE</b>	2	\$250.00
Foam Cell Pro Strut - Performance* (SEE NOTE)	<b>45715FE</b>	2	\$388.00

\*NOTE: MANDATORY FITMENT of UCA050FA and MITS045B /C Coil Springs with 45715FE

<sup>1</sup> Height adjustable with Ironman 4x4 Strut Trim Packers

#### COIL SPRINGS

	Est. Lift	Additional Load			
Medium	15mm	0 - 50kg	<b>MITSO40B</b>	1	\$250.00
Medium* (SEE NOTE)	50mm	0 - 50kg	<b>MITSO45B *</b>	1	\$250.00
Heavy	30mm	50 - 110kg	<b>MITSO40C</b>	1	\$250.00
Heavy* (SEE NOTE)	50mm	50 - 110kg	<b>MITSO45C *</b>	1	\$250.00

\*NOTE: MANDATORY FITMENT of UCA050FA and 45715FE with (MITSO45B /C) Coil Springs

#### STRUT MOUNTS

Steel Strut Top	<b>ISS010</b>	2	\$97.00
-----------------	---------------	---	---------

#### TRIM PACKERS

5mm Strut Trim Packer	Nitro Gas / Foam Cell	<b>HILFR05 / HILFR05F</b>	2	\$28.00
10mm Strut Trim Packer	Nitro Gas / Foam Cell	<b>HILFR10 / HILFR10F</b>	2	\$28.00
15mm Strut Trim Packer	Nitro Gas / Foam Cell	<b>HILFR15 / HILFR15F</b>	2	\$28.00

• ONLY Compatible with Ironman 4x4 Struts, lift height subject to 2:1 motion ratio. Unnecessary fitment may lift vehicle too high

#### CONTROL ARMS

Pro-Forge Upper Control Arms	<b>UCA050FA</b>	1	\$882.00
------------------------------	-----------------	---	----------

### REAR SUSPENSION

#### SHOCK ABSORBER

Nitro Gas - Performance	<b>12645GRS</b>	2	\$153.00
Foam Cell - Performance	<b>24645FES</b>	2	\$222.00

#### COIL SPRINGS

	Est. Lift	Additional Load			
Light	15mm	0 - 200kg	<b>MITSO42A</b>	1	\$250.00
Medium	30mm	0 - 250kg	<b>MITSO42B</b>	1	\$250.00
Medium - with Accessories	40mm	250-500kg	<b>MITSO20B</b>	1	\$250.00
Heavy	40mm	300kg - GVM	<b>MITSO42C</b>	1	\$250.00

• Check LHS rear coil captivity when lowering to ground

### SUSPENSION KIT

Medium - Nitro Gas	<b>MITSO42BKG1</b>	\$1247.00
Medium - Foam Cell	<b>MITSO42BKF1</b>	\$1441.00
Heavy - Nitro Gas	<b>MITSO42CKG1</b>	\$1247.00
Heavy - Foam Cell	<b>MITSO42CKF1</b>	\$1441.00

• Specify Front Coil Springs when ordering

• Please note limited lift height, due to restrictions in vehicle design.

### SUSPENSION KIT CONTENTS

Shock Absorbers

Strut Shock Absorbers

Coil Springs



# Mitsubishi Pajero

NW 2011 to NX



Product Description

Part No.

Qty  
Req

Retail  
ea Inc GST

## ACCESSORIES TO SUIT MITSUBISHI PAJERO

**STEEL WINCH BULL BARS - NOT SUITABLE FOR VEHICLES WITH FACTORY FITTED HEADLIGHT WASHERS (DRL'S NOT COMPATIBLE)**

Commercial Deluxe	<b>BBCD045</b>	\$2244.00
-------------------	----------------	-----------

**UNDERBODY PROTECTION**

Engine Bay and Transmission 2000+ - <i>While Stocks Last</i>	<b>IUP013K</b>	\$624.00
--	----------------	----------

**DIFF BREATHER KIT**

Diff Breather Kit	<b>IDIFFBRE</b>	\$115.00
-------------------	-----------------	----------





NM, NP, NS, NT  
5/2000 to 2011

# Mitsubishi Pajero

Product Description

Part No.

Qty  
Req

Retail  
ea Inc GST

## ACCESSORIES TO SUIT MITSUBISHI PAJERO

### STEEL WINCH BULL BARS - NOT SUITABLE FOR VEHICLES WITH FACTORY FITTED HEADLIGHT WASHERS (DRL'S NOT COMPATIBLE)

Commercial Deluxe - *Fits NS and NT models only*

**BBCD045**

\$2244.00

### UNDERBODY PROTECTION

Engine Bay and Transmission 2000+ - *While Stocks Last*

**IUP013K**

\$624.00

### DIFF BREATHER KIT

Diff Breather Kit

**IDIFFBRE**

\$115.00



Product Description

Part No.

Qty  
Req

Retail  
ea Inc GST

## SUSPENSION TO SUIT MITSUBISHI PAJERO

### FRONT SUSPENSION

#### SHOCK ABSORBER

Nitro Gas Strut - Performance			<b>12713GR</b>	2	\$222.00
Foam Cell Strut - Performance			<b>24713FE</b>	2	\$250.00

#### COIL SPRINGS

	Est. Lift	Additional Load			
Medium	40mm	0 - 50kg	<b>MITS038B</b>	1	\$250.00
Heavy - Diesel	40mm	50 - 100kg	<b>MITS038C</b>	1	\$250.00

### REAR SUSPENSION

#### SHOCK ABSORBER

Nitro Gas - Performance			<b>12714GR</b>	2	\$153.00
-------------------------	--	--	----------------	---	----------

#### COIL SPRINGS

	Est. Lift	Additional Load			
Medium - SWB	40mm	0 - 200kg	<b>MITS039A</b>	1	\$250.00
Medium - LWB	40mm	0 - 200kg	<b>MITS039B</b>	1	\$250.00
Heavy	40mm	200kg - GVM	<b>MITS039C</b>	1	\$250.00

### SUSPENSION KIT

Medium - Nitro Gas	SWB		<b>MITS038AKG</b>		\$1247.00
Medium - Nitro Gas	LWB	Petrol	<b>MITS038BKG</b>		\$1247.00
Medium - Nitro Gas	LWB	Diesel	<b>MITS038CKG</b>		\$1247.00
Heavy - Nitro Gas	LWB	Petrol	<b>MITS038CKG1</b>		\$1247.00
Heavy - Nitro Gas	LWB	Diesel	<b>MITS038CKG2</b>		\$1247.00

- Vehicles with monocoque body construction can be subject to increased NVH (Noise) with upgraded suspension installed
- Vehicles with independent suspension must maintain a minimum of 60mm downward suspension travel
- Mandatory 4 wheel alignment after installing new suspension
- Specify front Coil Springs when ordering

### SUSPENSION KIT CONTENTS

Shock Absorbers

Strut Shock Absorbers

Coil Springs





iO Pinin  
1999+

# Mitsubishi Pajero

Product Description

Part No.

Qty  
Req

Retail  
ea Inc GST

## SUSPENSION TO SUIT MITSUBISHI PAJERO

### FRONT SUSPENSION

**COIL SPRINGS**

	Est. Lift	Additional Load	Part No.	Qty	Retail Price
Medium	35mm	0 - 50kg	<b>MITSO34B</b>	1	\$250.00

**CAMBER CORRECTION**

Camber Bolt Kit			<b>ICAMBER14</b>	1	\$28.00
-----------------	--	--	------------------	---	---------

### REAR SUSPENSION

**COIL SPRINGS**

	Est. Lift	Additional Load	Part No.	Qty	Retail Price
Medium	35mm	0 - 200kg	<b>MITSO35B</b>	1	\$250.00



Product Description

Part No.

Qty  
Req

Retail  
ea Inc GST

## SUSPENSION TO SUIT MITSUBISHI PAJERO

### FRONT SUSPENSION

#### SHOCK ABSORBER

Nitro Gas - Performance		<b>12087GR</b>	2	\$153.00
Foam Cell - Performance		<b>24087FE</b>	2	\$222.00

#### TORSION BAR

Uprated Torsion Bars	1278mm Length	<b>MITS013</b>	1	\$416.00
Uprated Torsion Bars	1308mm Length	<b>MITS019</b>	1	\$416.00

- Check Torsion Bar length before ordering
- Minimum 60mm downward suspension travel required after adjustment

#### STEERING DAMPER

Foam Cell	Suits vehicles w/o power steering	<b>3517</b>	1	\$167.00
-----------	-----------------------------------	-------------	---	----------

### REAR SUSPENSION

#### SHOCK ABSORBER

Nitro Gas - Performance		<b>12646GR</b>	2	\$153.00
Foam Cell - Performance		<b>24646FE</b>	2	\$222.00

#### COIL SPRINGS

	Est. Lift	Additional Load			
Medium - SWB	40mm	0 - 200kg	<b>MITS022B</b>	1	\$250.00
Medium - LWB	40mm	0 - 200kg	<b>MITS020B</b>	1	\$250.00
Heavy	40mm	200kg - GVM	<b>MITS020C</b>	1	\$250.00

### SUSPENSION KIT

Medium - Nitro Gas	SWB	<b>MITS022BKG2</b>	\$1275.00
Medium - Nitro Gas	LWB	<b>MITS020BKG2</b>	\$1275.00
Medium - Foam Cell	SWB	<b>MITS022BKF2</b>	\$1552.00
Medium - Foam Cell	LWB	<b>MITS020BKF2</b>	\$1552.00
Heavy - Nitro Gas		<b>MITS020CKG2</b>	\$1275.00
Heavy - Foam Cell		<b>MITS020CKF2</b>	\$1552.00

- Check Torsion Bar length before ordering

### SUSPENSION KIT CONTENTS

Shock Absorbers

Coil Springs

Torsion Bars



Montero NH-NL (Leaf)  
1991 to 1999

# Mitsubishi Pajero

Product Description

Part No.

Qty  
Req

Retail  
ea Inc GST

## SUSPENSION TO SUIT MITSUBISHI PAJERO

### FRONT SUSPENSION

#### SHOCK ABSORBER

Nitro Gas - Performance		<b>12087GR</b>	2	\$153.00
Foam Cell - Performance		<b>24087FE</b>	2	\$222.00

#### TORSION BAR

Uprated Torsion Bars	1278mm Length	<b>MITSO13</b>	1	\$416.00
Uprated Torsion Bars	1308mm Length	<b>MITSO19</b>	1	\$416.00

- Check Torsion Bar length before ordering
- Minimum 60mm downward suspension travel required after adjustment

#### STEERING DAMPER

Foam Cell	Suits vehicles w/o power steering	<b>3517</b>	1	\$167.00
-----------	-----------------------------------	-------------	---	----------

### REAR SUSPENSION

#### SHOCK ABSORBER

Nitro Gas - Comfort		<b>12636GRC</b>	2	\$153.00
Nitro Gas - Performance		<b>12636GR</b>	2	\$153.00
Nitro Gas - Professional		<b>12636GRP</b>	2	\$153.00
Foam Cell - Comfort		<b>24636FEC</b>	2	\$222.00
Foam Cell - Performance		<b>24636FE</b>	2	\$222.00
Foam Cell - Professional		<b>24636FEP</b>	2	\$222.00

#### LEAF SPRINGS

	Est. Lift	Additional Load			
Medium	40mm	0 - 300kg	<b>MITSO18B</b>	2	\$375.00
Heavy	40mm	300kg - GVM	<b>MITSO18C</b>	2	\$402.00

- Must use Ironman 4x4 bushes

#### U-BOLTS

U-Bolt Kit		<b>451UBK</b>	2	\$42.00
------------	--	---------------	---	---------

#### POLYURETHANE SPRING BUSHES

Bush Kit		<b>715TUK</b>	1	\$84.00
----------	--	---------------	---	---------

#### GREASABLE SHACKLES AND PINS

Greasable Shackle		<b>795</b>	2	\$56.00
Greasable Pin		<b>796</b>	2	\$28.00

#### HELPER SPRINGS

Load Plus Helper Springs		<b>LP4</b>	1	\$157.00
--------------------------	--	------------	---	----------

### SUSPENSION KIT

Medium - Nitro Gas	<b>MITSO18BKG2</b>	\$1940.00
Medium - Foam Cell	<b>MITSO18BKF2</b>	\$2217.00
Heavy - Nitro Gas	<b>MITSO18CKG2</b>	\$1995.00
Heavy - Foam Cell	<b>MITSO18CKF2</b>	\$2272.00

- Check Torsion Bar length before ordering

### SUSPENSION KIT CONTENTS

Shock Absorbers  
Leaf Springs

Torsion Bars  
U-Bolts

Polyurethane Spring Bushes



# Mitsubishi Pajero

Montero NA-NG (Coil)  
1988 to 1991



Product Description

Part No.

Qty  
Req

Retail  
ea Inc GST

## SUSPENSION TO SUIT MITSUBISHI PAJERO

### FRONT SUSPENSION

#### SHOCK ABSORBER

Nitro Gas - Performance		<b>12082GR</b>	2	\$153.00
Foam Cell - Performance		<b>24082FE</b>	2	\$222.00

#### TORSION BAR

Uprated Torsion Bars	1278mm Length	<b>MITSO13</b>	1	\$416.00
Uprated Torsion Bars	1308mm Length	<b>MITSO19</b>	1	\$416.00

- Check Torsion Bar length before ordering
- Minimum 60mm downward suspension travel required after adjustment

#### STEERING DAMPER

Foam Cell	Suits vehicles w/o power steering	<b>3517</b>	1	\$167.00
-----------	-----------------------------------	-------------	---	----------

### REAR SUSPENSION

#### SHOCK ABSORBER

Nitro Gas - Comfort		<b>12645GRC</b>	2	\$153.00
Nitro Gas - Performance		<b>12645GR</b>	2	\$153.00
Foam Cell - Comfort		<b>24645FEC</b>	2	\$222.00
Foam Cell - Performance		<b>24645FE</b>	2	\$222.00

#### COIL SPRINGS

	Est. Lift	Additional Load			
Medium - SWB	40mm	0 - 200kg	<b>MITSO22B</b>	1	\$250.00
Medium - LWB	40mm	0 - 200kg	<b>MITSO20B</b>	1	\$250.00
Heavy	40mm	200kg - GVM	<b>MITSO20C</b>	1	\$250.00

### SUSPENSION KIT

Medium - Nitro Gas	SWB	<b>MITSO22BKG1</b>	\$1275.00
Medium - Nitro Gas	LWB	<b>MITSO20BKG1</b>	\$1275.00
Medium - Foam Cell	SWB	<b>MITSO22BKF1</b>	\$1402.00
Medium - Foam Cell	LWB	<b>MITSO20BKF1</b>	\$1552.00
Heavy - Nitro Gas		<b>MITSO20CKG1</b>	\$1275.00
Heavy - Foam Cell		<b>MITSO20CKF1</b>	\$1552.00

- Check Torsion Bar length before ordering

### SUSPENSION KIT CONTENTS

Shock Absorbers                      Coil Springs



Montero NA-NG (Leaf)  
Pre 1991

# Mitsubishi Pajero

Product Description

Part No.

Qty  
ReqRetail  
ea Inc GST

## SUSPENSION TO SUIT MITSUBISHI PAJERO

### FRONT SUSPENSION

#### SHOCK ABSORBER

Nitro Gas - Performance		<b>12082GR</b>	2	\$153.00
Foam Cell - Performance		<b>24082FE</b>	2	\$222.00

#### TORSION BAR

Uprated Torsion Bars	1278mm Length	<b>MITS013</b>	1	\$416.00
Uprated Torsion Bars	1308mm Length	<b>MITS019</b>	1	\$416.00

- Check Torsion Bar length before ordering
- Minimum 60mm downward suspension travel required after adjustment

#### STEERING DAMPER

Foam Cell	Suits vehicles w/o power steering	<b>3517</b>	1	\$167.00
-----------	-----------------------------------	-------------	---	----------

### REAR SUSPENSION

#### SHOCK ABSORBER

Nitro Gas - Comfort		<b>12636GRC</b>	2	\$153.00
Nitro Gas - Performance		<b>12636GR</b>	2	\$153.00
Nitro Gas - Professional		<b>12636GRP</b>	2	\$153.00
Foam Cell - Comfort		<b>24636FEC</b>	2	\$222.00
Foam Cell - Performance		<b>24636FE</b>	2	\$222.00
Foam Cell - Professional		<b>24636FEP</b>	2	\$222.00

#### LEAF SPRINGS

	Est. Lift	Additional Load			
Medium	45mm	0 - 300kg	<b>MITS018B</b>	2	\$375.00
Heavy	45mm	300kg - GVM	<b>MITS018C</b>	2	\$402.00

- Must use Ironman 4x4 bushes

#### U-BOLTS

U-Bolt Kit		<b>451UBK</b>	2	\$42.00
------------	--	---------------	---	---------

#### POLYURETHANE SPRING BUSHES

Bush Kit		<b>715UK</b>	1	\$84.00
----------	--	--------------	---	---------

#### GREASABLE SHACKLES AND PINS

Greasable Shackle		<b>795</b>	2	\$56.00
Greasable Pin		<b>796</b>	2	\$28.00

#### HELPER SPRINGS

Load Plus Helper Springs		<b>LP4</b>	1	\$157.00
--------------------------	--	------------	---	----------

### SUSPENSION KIT

Medium - Nitro Gas	<b>MITS018BKG1</b>	\$1940.00
Medium - Foam Cell	<b>MITS018BKF1</b>	\$2217.00
Heavy - Nitro Gas	<b>MITS018CKG1</b>	\$1995.00
Heavy - Foam Cell	<b>MITS018CKF1</b>	\$2272.00

- Check Torsion Bar length before ordering

### SUSPENSION KIT CONTENTS

Shock Absorbers  
Leaf Springs

Torsion Bars  
U-Bolts

Polyurethane Spring Bushes





Product Description

Part No.

Qty  
Req

Retail  
ea Inc GST

## SUSPENSION TO SUIT MITSUBISHI PAJERO

### FRONT SUSPENSION

#### SHOCK ABSORBER

Nitro Gas Strut - Performance			<b>12715GR</b>	2	\$222.00
Foam Cell Strut - Performance			<b>24715FE</b>	2	\$250.00

• Height adjustable with Ironman 4x4 Strut Trim Packers

#### COIL SPRINGS

	Est. Lift	Additional Load			
Standard Height	0mm	0 - 50kg	<b>MITSO40S</b>	1	\$250.00
Light	35mm	0 - 50kg	<b>MITSO40A</b>	1	\$250.00
Medium	40mm	0 - 80kg	<b>MITSO40B</b>	1	\$250.00
Heavy	40mm	80 - 110kg	<b>MITSO40C</b>	1	\$250.00

#### STRUT MOUNTS

Steel Strut Top			<b>ISST010</b>	2	\$97.00
-----------------	--	--	----------------	---	---------

#### TRIM PACKERS

5mm Strut Trim Packer	Nitro Gas / Foam Cell	<b>HILFR05 / HILFR05F</b>	2	\$28.00
10mm Strut Trim Packer	Nitro Gas / Foam Cell	<b>HILFR10 / HILFR10F</b>	2	\$28.00
15mm Strut Trim Packer	Nitro Gas / Foam Cell	<b>HILFR15 / HILFR15F</b>	2	\$28.00

• ONLY Compatible with Ironman 4x4 Struts (except Pro), lift height subject to 2:1 motion ratio. Unnecessary fitment may lift vehicle too high

### REAR SUSPENSION

#### SHOCK ABSORBER

Nitro Gas - Performance			<b>12645GRS</b>	2	\$153.00
Foam Cell - Performance			<b>24645FES</b>	2	\$222.00

#### COIL SPRINGS

	Est. Lift	Additional Load			
Standard	0mm	0 - 250kg	<b>MITSO42S</b>	1	\$250.00
Light	20mm	0 - 250kg	<b>MITSO42A</b>	1	\$250.00
Medium	40mm	0 - 250kg	<b>MITSO42B</b>	1	\$250.00
Heavy	40mm	250kg - GVM	<b>MITSO42C</b>	1	\$250.00

### SUSPENSION KIT

Standard - Nitro Gas	<b>MITSO42SKG</b>	\$1247.00
Standard - Foam Cell	<b>MITSO42SKF</b>	\$1441.00
Light - Nitro Gas	<b>MITSO42AKG</b>	\$1247.00
Light - Foam Cell	<b>MITSO42AKF</b>	\$1441.00
Medium - Nitro Gas	<b>MITSO42BKG</b>	\$1247.00
Medium - Foam Cell	<b>MITSO42BKF</b>	\$1441.00
Heavy - Nitro Gas	<b>MITSO42CKG</b>	\$1247.00
Heavy - Foam Cell	<b>MITSO42CKF</b>	\$1441.00

• Specify Front Coil Springs when ordering

### SUSPENSION KIT CONTENTS

Shock Absorbers	Coil Springs
Strut Shock Absorbers	



Challenger / Montero Sport PA (Coil)  
1998 to 2008

# Mitsubishi Pajero

Product Description

Part No.

Qty  
ReqRetail  
ea Inc GST

## SUSPENSION TO SUIT MITSUBISHI PAJERO

### FRONT SUSPENSION

#### SHOCK ABSORBER

Nitro Gas - Performance	<b>12087GR</b>	2	\$153.00
Foam Cell - Performance	<b>24087FE</b>	2	\$222.00

#### TORSION BAR

Uprated Torsion Bars	<b>MITSO19</b>	1	\$416.00
----------------------	----------------	---	----------

• Minimum 60mm downward suspension travel required after adjustment

### REAR SUSPENSION

#### SHOCK ABSORBER

Nitro Gas - Comfort	<b>12645GRC</b>	2	\$153.00
Nitro Gas - Performance	<b>12645GR</b>	2	\$153.00
Foam Cell - Comfort	<b>24645FEC</b>	2	\$222.00
Foam Cell - Performance	<b>24645FE</b>	2	\$222.00

#### COIL SPRINGS

	Est. Lift	Additional Load			
Medium	40mm	0 - 200kg	<b>MITSO22B</b>	1	\$250.00
Heavy	40mm	200-400kg	<b>MITSO20B</b>	1	\$250.00
Extra Heavy	40mm	400kg - GVM	<b>MITSO20C</b>	1	\$250.00

### SUSPENSION KIT

Medium - Nitro Gas	<b>MITSO22BKG</b>	\$1275.00
Medium - Foam Cell	<b>MITSO22BKF</b>	\$1552.00
Heavy - Nitro Gas	<b>MITSO20BKG</b>	\$1275.00
Heavy - Foam Cell	<b>MITSO20BKF</b>	\$1552.00
Extra Heavy - Nitro Gas	<b>MITSO20CKG</b>	\$1275.00
Extra Heavy - Foam Cell	<b>MITSO20CKF</b>	\$1552.00

### SUSPENSION KIT CONTENTS

Shock Absorbers	Torsion Bars	Polyurethane Spring Bushes
Leaf Springs	U-Bolts	

# Mitsubishi Pajero

Montero Sport (Leaf)  
1998 to 2006



Product Description

Part No.

Qty  
Req

Retail  
ea Inc GST

## SUSPENSION TO SUIT MITSUBISHI PAJERO

### FRONT SUSPENSION

#### SHOCK ABSORBER

Nitro Gas - Performance	<b>12087GR</b>	2	\$153.00
Foam Cell - Performance	<b>24087FE</b>	2	\$222.00

#### TORSION BAR

Up-rated Torsion Bars	<b>MITSO19</b>	1	\$416.00
-----------------------	----------------	---	----------

• Minimum 60mm downward suspension travel required after adjustment

### REAR SUSPENSION

#### SHOCK ABSORBER

Nitro Gas - Comfort	<b>12636GRC</b>	2	\$153.00
Nitro Gas - Performance	<b>12636GR</b>	2	\$153.00
Nitro Gas - Professional	<b>12636GRP</b>	2	\$153.00
Foam Cell - Comfort	<b>24636FEC</b>	2	\$222.00
Foam Cell - Performance	<b>24636FE</b>	2	\$222.00
Foam Cell - Professional	<b>24636FEP</b>	2	\$222.00

#### LEAF SPRINGS

	Est. Lift	Additional Load			
Medium	40mm	0 - 300kg	<b>MITSO18B</b>	2	\$375.00
Heavy	40mm	300kg - GVM	<b>MITSO18C</b>	2	\$402.00

• Must use Ironman 4x4 bushes

#### U-BOLTS

U-Bolt Kit	<b>451UBK</b>	2	\$42.00
------------	---------------	---	---------

#### POLYURETHANE SPRING BUSHES

Bush Kit	<b>715STUK</b>	1	\$84.00
----------	----------------	---	---------

• Not compatible with OEM springs

#### GREASABLE SHACKLES AND PINS

Greasable Shackle	<b>795</b>	2	\$56.00
Greasable Pin	<b>796</b>	2	\$28.00

#### HELPER SPRINGS

Load Plus Helper Springs	<b>LP4</b>	1	\$157.00
--------------------------	------------	---	----------

### SUSPENSION KIT

Medium - Nitro Gas	<b>MITSO18BKG</b>	\$1940.00
Medium - Foam Cell	<b>MITSO18BKF</b>	\$2217.00
Heavy - Nitro Gas	<b>MITSO18CKG</b>	\$1995.00
Heavy - Foam Cell	<b>MITSO18CKF</b>	\$2272.00

### SUSPENSION KIT CONTENTS

Shock Absorbers

Coil Springs

Torsion Bars



L400  
1994+

# Mitsubishi Delica

Product Description

Part No.

Qty  
Req

Retail  
ea Inc GST

## SUSPENSION TO SUIT MITSUBISHI DELICA

### FRONT SUSPENSION

#### SHOCK ABSORBER

Nitro Gas - Performance	<b>12667GR</b>	2	\$153.00
Foam Cell - Performance	<b>24667FE</b>	2	\$222.00

#### TORSION BAR

Uprated Torsion Bars	<b>MITS031</b>	1	\$416.00
----------------------	----------------	---	----------

- Torsion Bars suit vehicles 5/1994-5/1999 only
- Minimum 60mm downward suspension travel required after adjustment

### REAR SUSPENSION

#### SHOCK ABSORBER

Nitro Gas - Performance	Without ECS	<b>12698GR</b>	2	\$153.00
Nitro Gas - Performance	With ECS	<b>12671GR</b>	2	\$153.00

- ECS - Electronic Control Suspension

#### COIL SPRINGS

	Est. Lift	Additional Load			
Medium	40mm	0 - 250kg	<b>MITS025B</b>	1	\$250.00

### SUSPENSION KIT

Medium - Nitro Gas	Without ECS	<b>MITS031BKG</b>	\$1275.00
Medium - Nitro Gas	With ECS	<b>MITS031BKG1</b>	\$1275.00

- Shock Absorbers do not re-connect to ECS system

### SUSPENSION KIT CONTENTS

Shock Absorbers                      Coil Springs                      Torsion Bars





Product Description

Part No.

Qty  
Req

Retail  
ea Inc GST

## ACCESSORIES TO SUIT MITSUBISHI TRITON

### STEEL WINCH BULL BARS (INCLUDING GLS PREMIUM)

Commercial Deluxe	BBCD067	\$2284.00
Proguard No Loop	BBT067-NL	\$1888.00
Proguard Single Loop Kit	BB067-SL	\$336.00
Proguard Triple Loop Kit	BB067-TL	\$404.00
Driving Light Patch Loom - Factory LED Headlight models only	IPL067	\$31.00
Load Resistor Kit with Mounting Brackets for Indicator / Parker Replacement	LR12V21W	\$56.00

• Winch with Steel Cable and Roller Fairlead is not suitable - Use Winch with Synthetic Rope and Alloy Hawse only

### STEEL SIDE STEPS AND RAILS - FITS DUAL AND CLUB CAB

Side Steps	SS050	\$962.00
Side Rails	SS050 RAIL	\$317.00
Side Steps and Rails	SSR050	\$1155.00

### TOWING (GLS MODEL ONLY)

Class 4 Towbar - Compatible with Factory Rear Bumper	TB050	\$581.00
Rear Protection Towbar - Full Rear Bumper Replacement	RTB067GLS	\$1328.00
Rear Protection Towbar Plates (Pair)	RTBPLATE050	\$146.00
Towbar Wiring Loom - Plug and Play	ITBL067	\$447.00

### TOWING (NOT GLS MODEL)

Class 4 Towbar - Compatible with Factory Rear Bumper	TB050	\$581.00
Rear Protection Towbar - Full Rear Bumper Replacement	RTB067GLX	\$1328.00
Rear Protection Towbar Plates (Pair)	RTBPLATE050	\$146.00
Towbar Wiring Loom - Plug and Play	ITBL067	\$447.00

### RECOVERY POINTS - IRONMAN 4X4 BULL BAR ONLY

Recovery Points - 5000kg Rating (Pair) (Includes GLS Premium)	IRP059	\$325.00
---	--------	----------

### SNORKEL

MR Triton - GLS and GSR only. Not compatible with GLX model	ISNORKEL067	\$418.00
---	-------------	----------

### BATTERY TRAY

Suits 12" Battery	IBTRAY050	\$229.00
-------------------	-----------	----------

### LONG RANGE FUEL TANK

125L* Diesel only - Fits Dual and Extra Cab only	TANK004	\$1129.00
--	---------	-----------

\* Usable volume may differ to the stated tank capacity

### PREMIUM UNDERBODY PROTECTION

Engine Bay and Transmission	UBP050	\$748.00
-----------------------------	--------	----------

### UNDERBODY PROTECTION

Engine Bay and Transmission - Not compatible with bull bars. - While Stocks Last	IUP050K	\$563.00
--	---------	----------

### EXHAUST SYSTEM

3" Exhaust Upgrade 2.4L 2015+ - DPF Back - While Stocks Last	IEX067	\$770.00
--	--------	----------

### LOCKSAFE DRAWER SYSTEMS

Twin Drawers - 1300mm	ITD1300	\$1469.00
Single Drawer - 1300mm	ISD1300	\$891.00
Wing Kit - 1300mm*	ITDW050	\$351.00

\*Designed to suit factory tubs, will not suit ute liner without modification.



MR  
11/2018+

## Mitsubishi Triton

Product Description	Part No.	Qty Req	Retail ea Inc GST
<b>CANOPY - ABS PLASTIC (SIDE LIFT UP WINDOWS AND CENTRAL LOCKING REAR DOOR) - FITS 4X4 AND 4X2 DUAL CAB MODELS</b>			
Pre Primed	CANOPY014-P		\$3238.00*
Black Mica (X08)	CANOPY014-BM		\$3856.00
Impulse Blue (D23)	CANOPY014-IB		\$3856.00
Graphite Grey (U28)	CANOPY014-GG		\$3856.00
White Solid (W32)	CANOPY014-WS		\$3856.00
ABS Canopy Rack Feet	IRRFEETABS14		\$274.00
<ul style="list-style-type: none"> <li>• See Page 37 and 38 for 1.4m Roof Rack options and pricing.</li> <li>* Pre-primed canopies, plus colour coding.</li> </ul>			
<b>CANOPY - PINNACLE SMOOTH FINISH FIBREGLASS (SIDE LIFT UP WINDOWS AND CENTRAL LOCKING REAR DOOR) - FITS 4X4 AND 4X2 DUAL CAB MODELS</b>			
Pre-Primed	CANFIBRE050-P		\$2899.00*
Black Mica (X08)	CANFIBRE050-BM		\$3399.00
Impulse Blue (D23)	CANFIBRE050-IB		\$3399.00
Graphite Grey (U28)	CANFIBRE050-GG		\$3399.00
Sterling Silver (U25)	CANFIBRE050-SS		\$3399.00
White Solid (W32)	CANFIBRE050-WS		\$3399.00
* Pre-primed canopies, plus colour coding.			
<b>CANOPY - PINNACLE 2 FIBREGLASS (SIDE LIFT UP WINDOWS AND CENTRAL LOCKING REAR DOOR) - FITS 4X4 AND 4X2 DUAL CAB MODELS</b>			
Pre-Primed	ICANOPY050-P		\$2899.00*
Black Mica (X08)	ICANOPY050-BM		\$3399.00
Graphite Grey (U28)	ICANOPY050-GG		\$3399.00
Impulse Blue (D23)	ICANOPY050-IB		\$3399.00
Sterling Silver (U25)	ICANOPY050-SS		\$3399.00
Titanium Grey (U17)	ICANOPY050-TG		\$3399.00
White Solid (W32)	ICANOPY050-WS		\$3399.00
<b>SLIDE-AWAY ROLL UP HARD TONNEAU COVER</b>			
Electric with Remote Control	ISLIDEAWAY067-E		\$2599.00
<b>SEAT COVER</b>			
Canvas Comfort - Front	ICSC050F		\$401.00
Canvas Comfort - Rear	ICSC050R		\$401.00
<b>DIFF BREATHER KIT</b>			
Diff Breather Kit	IDIFFBRE		\$115.00

 LISTING  
CONTINUED  
OVER THE  
PAGE



Product Description

Part No.

Qty  
Req

Retail  
ea Inc GST

SUSPENSION TO SUIT MITSUBISHI TRITON MR

FRONT SUSPENSION

SHOCK ABSORBER

Nitro Gas Strut - Performance <sup>1</sup>			<b>12715GR</b>	2	\$222.00
Foam Cell Strut - Performance <sup>1</sup>			<b>24715FE</b>	2	\$250.00
Foam Cell Pro Strut - Performance* (SEE NOTE)			<b>45715FE</b>	2	\$388.00

\*NOTE: MANDATORY FITMENT of UCA050FA and MITS045B /C Coil Springs with 45715FE

<sup>1</sup> Height adjustable with Ironman 4x4 Strut Trim Packers

COIL SPRINGS

	Est. Lift	Additional Load			
Standard	0mm	0 - 50kg	<b>MITSO40S</b>	1	\$250.00
Light	25mm	0 - 50kg	<b>MITSO40A</b>	1	\$250.00
Medium	30mm	0 - 80kg	<b>MITSO40B</b>	1	\$250.00
Medium* (SEE NOTE)	50mm	0 - 80kg	<b>MITSO45B *</b>	1	\$250.00
Heavy	30mm	80 - 110kg	<b>MITSO40C</b>	1	\$250.00
Heavy* (SEE NOTE)	50mm	80 - 110kg	<b>MITSO45C *</b>	1	\$250.00

\*NOTE: MANDATORY FITMENT of UCA050FA and 45715FE with (MITSO45B /C) Coil Springs

STRUT MOUNTS

Steel Strut Top			<b>ISST010</b>	2	\$97.00
-----------------	--	--	----------------	---	---------

TRIM PACKERS

5mm Strut Trim Packer	Nitro Gas / Foam Cell	<b>HILFR05 / HILFR05F</b>	2	\$28.00
10mm Strut Trim Packer	Nitro Gas / Foam Cell	<b>HILFR10 / HILFR10F</b>	2	\$28.00
15mm Strut Trim Packer	Nitro Gas / Foam Cell	<b>HILFR15 / HILFR15F</b>	2	\$28.00

• ONLY Compatible with Ironman 4x4 Struts, lift height subject to 2:1 motion ratio. Unnecessary fitment may lift vehicle too high

CONTROL ARMS

Pro-Forge Upper Control Arms			<b>UCA050FA</b>	1	\$882.00
------------------------------	--	--	-----------------	---	----------

MR  
11/2018+

## Mitsubishi Triton

Product Description	Part No.	Qty Req	Retail ea Inc GST
<b>REAR SUSPENSION</b>			
<b>SHOCK ABSORBER</b>			
Nitro Gas - Comfort	12729GRC	2	\$153.00
Nitro Gas - Performance	12729GR	2	\$153.00
Nitro Gas - Professional	12729GRP	2	\$153.00
Foam Cell - Comfort	24729FEC	2	\$222.00
Foam Cell - Performance	24729FE	2	\$222.00
Foam Cell - Professional	24729FEP	2	\$222.00
Foam Cell Pro - Comfort	45729FEC	2	\$305.00
Foam Cell Pro - Performance	45729FE	2	\$305.00
Foam Cell Pro - Professional	45729FEP	2	\$305.00
<b>LEAF SPRINGS</b>			
	Est. Lift	Additional Load	
Light	30mm	0 - 200kg	MITS047A 2 \$375.00
Medium	30mm	0 - 300kg	MITS047B 2 \$375.00
Heavy	30mm	300kg - GVM	MITS047C 2 \$402.00
• Two piece tailshaft models may experience driveline vibration, use 1201K to reduce vibration.			
<b>U-BOLTS</b>			
U-Bolt Kit			437UBK 2 \$42.00
U-Bolt Kit	Suits MITS047C		437UBKL 2 \$42.00
<b>POLYURETHANE SPRING BUSHES</b>			
Bush Kit			1200UK 1 \$84.00
<b>DRIVELINE SPACERS</b>			
Centre Bearing Spacer Kit			1201K 1 \$111.00
<b>SPACER KIT</b>			
Brake Hose Relocation Kit			1205K 1 \$56.00
<b>GREASABLE SHACKLES AND PINS</b>			
Greasable Shackle			1199 2 \$56.00
Non-Greasable Pin			387-1 2 \$28.00
<b>HELPER SPRINGS</b>			
Add-A-Leaf			ISL6010 1 \$167.00
<b>SUSPENSION KIT</b>			
Light - Nitro Gas	MITS047AKG		\$2078.00
Light - Foam Cell	MITS047AKF		\$2272.00
Medium - Nitro Gas	MITS047BKG		\$2078.00
Medium - Foam Cell	MITS047BKF		\$2272.00
Medium - Foam Cell Pro	MITS047BKP		\$3597.00
Heavy - Nitro Gas	MITS047CKG		\$2134.00
Heavy - Foam Cell	MITS047CKF		\$2328.00
Heavy - Foam Cell Pro	MITS047CKP		\$3652.20
• Specify Front Coil Springs when ordering			
• Two piece tailshaft models may experience driveline vibration, use 1201K to reduce vibration			
<b>SUSPENSION KIT CONTENTS</b>			
Shock Absorbers	Coil Springs	Upper Control Arms (Foam Cell Pro Kits Only)	Brake Hose Relocation Kit
Leaf Springs	U-Bolts	Polyurethane Spring Bushes	Centre Bearing Spacer Kit
Strut Shock Absorbers			



Product Description

Part No.

Qty  
Req

Retail  
ea Inc GST

ACCESSORIES TO SUIT MITSUBISHI TRITON

**STEEL WINCH BULL BARS**

Commercial	<b>BBC050</b>	\$1678.00
Commercial Deluxe	<b>BBCD050</b>	\$2284.00
Polished Alloy	<b>BBA050</b>	\$2845.00
Proguard No Loop	<b>BBT050-NL</b>	\$1888.00
Proguard Single Loop Kit	<b>BB050-SL</b>	\$336.00
Proguard Triple Loop Kit	<b>BB050-TL</b>	\$404.00
Driving Light Patch Loom - Factory LED Headlight models only	<b>IPL050</b>	\$31.00

**STEEL SIDE STEPS AND RAILS - FITS DUAL AND CLUB CAB**

Side Steps	<b>SS050</b>	\$962.00
Side Rails	<b>SS050 RAIL</b>	\$317.00
Side Steps and Rails	<b>SSR050</b>	\$1155.00

**TOWING**

Class 4 Towbar - Compatible with Factory Rear Bumper	<b>TB050</b>	\$581.00
Rear Protection Towbar - Full Rear Bumper Replacement	<b>RTB050</b>	\$1328.00
Rear Protection Towbar Plates (Pair)	<b>RTBPLATE050</b>	\$146.00
Towbar Wiring Loom - Plug and Play	<b>ITBL050</b>	\$264.00

**RECOVERY POINTS - IRONMAN 4X4 BULL BAR ONLY**

Recovery Points - 5000kg Rating (Pair)	<b>IRP050</b>	\$287.00
--	---------------	----------

**SNORKEL**

Triton MQ 2015-10/2018 Only - Suits 2.4L Diesel Only	<b>ISNORKEL050</b>	\$418.00
--	--------------------	----------

**BATTERY TRAY**

Suits 12" Battery	<b>IBTRAY050</b>	\$229.00
-------------------	------------------	----------

**LONG RANGE FUEL TANK**

125L* Diesel only - Fits Dual and Extra Cab only	<b>TANK004</b>	\$1129.00
--	----------------	-----------

\* Usable volume may differ to the stated tank capacity

**PREMIUM UNDERBODY PROTECTION**

Engine Bay and Transmission	<b>UBP050</b>	\$748.00
-----------------------------	---------------	----------

**UNDERBODY PROTECTION**

Engine Bay and Transmission - Not compatible with bull bars. - <i>While Stocks Last</i>	<b>IUP050K</b>	\$563.00
---	----------------	----------

**EXHAUST SYSTEM**

3" Exhaust Upgrade 2.4L 2015+ - DPF Back - <i>While Stocks Last</i>	<b>IEX067</b>	\$770.00
---	---------------	----------

**LOCKSAFE DRAWER SYSTEMS**

Twin Drawers - 1300mm	<b>ITD1300</b>	\$1469.00
Single Drawer - 1300mm	<b>ISD1300</b>	\$891.00
Wing Kit - 1300mm*	<b>ITDW050</b>	\$351.00

\*Designed to suit factory tubs, will not suit ute liner without modification.



MQ  
2015 to 10/2018

# Mitsubishi Triton

Product Description	Part No.	Qty Req	Retail ea Inc GST
<b>CANOPY - ABS PLASTIC (SIDE LIFT UP WINDOWS AND CENTRAL LOCKING REAR DOOR) - FITS 4X4 AND 4X2 DUAL CAB MODELS</b>			
Pre Primed	CANOPY014-P		\$3238.00*
Black Mica (X08)	CANOPY014-BM		\$3856.00
Impulse Blue (D23)	CANOPY014-IB		\$3856.00
White Solid (W32)	CANOPY014-WS		\$3856.00
ABS Canopy Rack Feet	IRRFEETABS14		\$274.00
• See Page 37 and 38 for 1.4m Roof Rack options and pricing. * Pre-primed canopies, plus colour coding.			
<b>CANOPY - PINNACLE SMOOTH FINISH FIBREGLASS (SIDE LIFT UP WINDOWS AND CENTRAL LOCKING REAR DOOR) - FITS 4X4 AND 4X2 DUAL CAB MODELS</b>			
Pre-Primed	CANFIBRE050-P		\$2899.00*
Black Mica (X08)	CANFIBRE050-BM		\$3399.00
Impulse Blue (D23)	CANFIBRE050-IB		\$3399.00
Titanium Grey (U17)	CANFIBRE050-TG		\$3399.00
Sterling Silver (U25)	CANFIBRE050-SS		\$3399.00
White Solid (W32)	CANFIBRE050-WS		\$3399.00
* Pre-primed canopies, plus colour coding.			
<b>CANOPY - PINNACLE 2 FIBREGLASS (SIDE LIFT UP WINDOWS AND CENTRAL LOCKING REAR DOOR) - FITS 4X4 AND 4X2 DUAL CAB MODELS</b>			
Pre-Primed	ICANOPY050-P		\$2899.00*
Black Mica (X08)	ICANOPY050-BM		\$3399.00
Graphite Grey (U28)	ICANOPY050-GG		\$3399.00
Impulse Blue (D23)	ICANOPY050-IB		\$3399.00
Sterling Silver (U25)	ICANOPY050-SS		\$3399.00
Titanium Grey (U17)	ICANOPY050-TG		\$3399.00
White Solid (W32)	ICANOPY050-WS		\$3399.00
<b>SLIDE-AWAY ROLL UP HARD TONNEAU COVER</b>			
Electric with Remote Control	ISLIDEAWAY067-E		\$2599.00
<b>SEAT COVER</b>			
Canvas Comfort - Front	ICSC050F		\$401.00
Canvas Comfort - Rear	ICSC050R		\$401.00
<b>DIFF BREATHER KIT</b>			
Diff Breather Kit	IDIFFBRE		\$115.00

LISTING  
CONTINUED  
OVER THE  
PAGE





Product Description

Part No.

Qty  
Req

Retail  
ea Inc GST

SUSPENSION TO SUIT MITSUBISHI TRITON

FRONT SUSPENSION

SHOCK ABSORBER

Nitro Gas Strut - Performance <sup>1</sup>			<b>12715GR</b>	2	\$222.00
Foam Cell Strut - Performance <sup>1</sup>			<b>24715FE</b>	2	\$250.00
Foam Cell Pro Strut - Performance* (SEE NOTE)			<b>45715FE</b>	2	\$388.00

\*NOTE: MANDATORY FITMENT of UCA050FA and MITS045B /C Coil Springs with 45715FE

<sup>1</sup> Height adjustable with Ironman 4x4 Strut Trim Packers

COIL SPRINGS

	Est. Lift	Additional Load			
Standard	0mm	0 - 50kg	<b>MITSO40S</b>	1	\$250.00
Light	25mm	0 - 50kg	<b>MITSO40A</b>	1	\$250.00
Medium	30mm	0 - 80kg	<b>MITSO40B</b>	1	\$250.00
Medium* (SEE NOTE)	50mm	0 - 80kg	<b>MITSO45B *</b>	1	\$250.00
Heavy	30mm	80 - 110kg	<b>MITSO40C</b>	1	\$250.00
Heavy* (SEE NOTE)	50mm	80 - 110kg	<b>MITSO45C *</b>	1	\$250.00

\*NOTE: MANDATORY FITMENT of UCA050FA and 45715FE with (MITSO45B /C) Coil Springs

STRUT MOUNTS

Steel Strut Top			<b>ISST010</b>	2	\$97.00
-----------------	--	--	----------------	---	---------

TRIM PACKERS

5mm Strut Trim Packer	Nitro Gas / Foam Cell	<b>HILFR05 / HILFR05F</b>	2	\$28.00
10mm Strut Trim Packer	Nitro Gas / Foam Cell	<b>HILFR10 / HILFR10F</b>	2	\$28.00
15mm Strut Trim Packer	Nitro Gas / Foam Cell	<b>HILFR15 / HILFR15F</b>	2	\$28.00

• ONLY Compatible with Ironman 4x4 Struts, lift height subject to 2:1 motion ratio. Unnecessary fitment may lift vehicle too high

CONTROL ARMS

Pro-Forge Upper Control Arms			<b>UCA050FA</b>	1	\$882.00
------------------------------	--	--	-----------------	---	----------





MQ L200  
2015 to 10/2018

SUSPENSION TO SUIT

# Mitsubishi Triton

## Product Description

## Part No.

## Qty Req

## Retail ea Inc GST

### REAR SUSPENSION

#### SHOCK ABSORBER

Nitro Gas - Comfort			<b>12729GRC</b>	2	\$153.00
Nitro Gas - Performance			<b>12729GR</b>	2	\$153.00
Nitro Gas - Professional			<b>12729GRP</b>	2	\$153.00
Foam Cell - Comfort			<b>24729FEC</b>	2	\$222.00
Foam Cell - Performance			<b>24729FE</b>	2	\$222.00
Foam Cell - Professional			<b>24729FEP</b>	2	\$222.00
Foam Cell Pro - Comfort			<b>45729FEC</b>	2	\$305.00
Foam Cell Pro - Performance			<b>45729FE</b>	2	\$305.00
Foam Cell Pro - Professional			<b>45729FEP</b>	2	\$305.00

#### LEAF SPRINGS

	Est. Lift	Additional Load			
Light	30mm	0 - 200kg	<b>MITSO47A</b>	2	\$375.00
Medium	30mm	0 - 300kg	<b>MITSO47B</b>	2	\$375.00
Heavy	30mm	300kg - GVM	<b>MITSO47C</b>	2	\$402.00

• Two piece tailshaft models may experience driveline vibration, use 1201K to reduce vibration.

#### U-BOLTS

U-Bolt Kit			<b>437UBK</b>	2	\$42.00
U-Bolt Kit	Suits MITS047C		<b>437UBKL</b>	2	\$42.00

#### POLYURETHANE SPRING BUSHES

Bush Kit			<b>1200UK</b>	1	\$84.00
----------	--	--	---------------	---	---------

#### DRIVELINE SPACERS

Centre Bearing Spacer Kit			<b>1201K</b>	1	\$111.00
---------------------------	--	--	--------------	---	----------

#### SPACER KIT

Brake Hose Relocation Kit			<b>1205K</b>	1	\$56.00
---------------------------	--	--	--------------	---	---------

#### GREASABLE SHACKLES AND PINS

Greasable Shackle			<b>1199</b>	2	\$56.00
Non-Greasable Pin			<b>387-1</b>	2	\$28.00

#### HELPER SPRINGS

Add-A-Leaf			<b>ISL6010</b>	1	\$167.00
------------	--	--	----------------	---	----------

### SUSPENSION KIT

Light - Nitro Gas		<b>MITSO47AKG</b>	\$2078.00
Light - Foam Cell		<b>MITSO47AKF</b>	\$2272.00
Medium - Nitro Gas		<b>MITSO47BKG</b>	\$2078.00
Medium - Foam Cell		<b>MITSO47BKF</b>	\$2272.00
Medium - Foam Cell Pro		<b>MITSO47BKP</b>	\$3597.00
Heavy - Nitro Gas		<b>MITSO47CKG</b>	\$2134.00
Heavy - Foam Cell		<b>MITSO47CKF</b>	\$2328.00
Heavy - Foam Cell Pro		<b>MITSO47CKP</b>	\$3652.20

• Specify Front Coil Springs when ordering

• Two piece tailshaft models may experience driveline vibration, use 1201K to reduce vibration

### SUSPENSION KIT CONTENTS

Shock Absorbers	Coil Springs	Upper Control Arms (Foam Cell Pro Kits Only)	Brake Hose Relocation Kit
Leaf Springs	U-Bolts	Polyurethane Spring Bushes	Centre Bearing Spacer Kit
Strut Shock Absorbers			



Delivered straight from the dealership...  
built your way!



for a full range of accessories visit our website

[www.ironman4x4.com](http://www.ironman4x4.com)







MN  
2009 to 2015

# Mitsubishi Triton

Product Description

Part No.

Qty  
Req

Retail  
ea Inc GST

## ACCESSORIES TO SUIT MITSUBISHI TRITON

### STEEL WINCH BULL BARS

Commercial	BBC031	\$1648.00
Commercial Deluxe	BBCD031	\$2244.00
Protector - <i>While Stocks Last</i>	BBT031	\$2271.00

• Can also be fitted to both 2WD and 4WD models.

### STEEL SIDE STEPS AND RAILS - FITS DUAL CAB, EXTRA CAB AND SINGLE CAB

Side Steps	SS031	\$962.00
Side Steps and Rails	SSR031	\$1155.00

### SNORKEL

Triton	ISNORKEL020	\$418.00
--------	-------------	----------

### EXHAUST SYSTEM

BigBore Triton MN - Diesel Only (Automatic Transmission) - <i>While Stocks Last</i>	IEXHAUST019	\$1301.00
---	-------------	-----------

### LONG RANGE FUEL TANK

125L* Diesel - Fits Dual Cab only	TANK004	\$1129.00
125L* Petrol - Fits Dual Cab only	TANK005	\$1129.00

\* Usable volume may differ to the stated tank capacity

• Modification required with factory rear diff-lock.

### LOCKSAFE DRAWER SYSTEMS

Twin Drawers - 1300mm	ITD1300	\$1469.00
Single Drawer - 1300mm	ISD1300	\$891.00
Wing Kit - 1300mm*	ITDW032	\$351.00

\* Designed to suit factory tubs, will not suit ute liner without modification.

### CANOPY - ABS PLASTIC (SIDE LIFT UP WINDOWS) - FITS 4X4 AND 4X2 DUAL CAB MODELS

Blue Mica (T64)	CANOPY008-BM	\$3856.00
-----------------	--------------	-----------

\* Pre-primed canopies, plus colour coding.

### SEAT COVER

Canvas Comfort - Front	ICSC031F	\$401.00
Canvas Comfort - Rear	ICSC031R	\$401.00

### DIFF BREATHER KIT

Diff Breather Kit	IDIFFBRE	\$115.00
-------------------	----------	----------

LISTING  
CONTINUED  
OVER THE  
PAGE



Product Description

Part No.

Qty  
Req

Retail  
ea Inc GST

SUSPENSION TO SUIT MITSUBISHI TRITON

FRONT SUSPENSION

SHOCK ABSORBER

Nitro Gas Strut - Performance <sup>1</sup>			<b>12715GR</b>	2	\$222.00
Foam Cell Strut - Performance <sup>1</sup>			<b>24715FE</b>	2	\$250.00
Foam Cell Pro Strut - Performance* (SEE NOTE)			<b>45715FE</b>	2	\$388.00

\*NOTE: MANDATORY FITMENT of UCA050FA and MITS045B /C Coil Springs with 45715FE

<sup>1</sup> Height adjustable with Ironman 4x4 Strut Trim Packers

COIL SPRINGS

	Est. Lift	Additional Load			
Standard	0mm	0 - 50kg	<b>MITSO40S</b>	1	\$250.00
Light	25mm	0 - 50kg	<b>MITSO40A</b>	1	\$250.00
Medium	30mm	0 - 80kg	<b>MITSO40B</b>	1	\$250.00
Medium* (SEE NOTE)	50mm	0 - 80kg	<b>MITSO45B *</b>	1	\$250.00
Heavy	30mm	80 - 110kg	<b>MITSO40C</b>	1	\$250.00
Heavy* (SEE NOTE)	50mm	80 - 110kg	<b>MITSO45C *</b>	1	\$250.00

\*NOTE: MANDATORY FITMENT of UCA050FA and 45715FE with (MITSO45B /C) Coil Springs

STRUT MOUNTS

Steel Strut Top			<b>ISST010</b>	2	\$97.00
-----------------	--	--	----------------	---	---------

TRIM PACKERS

5mm Strut Trim Packer	Nitro Gas / Foam Cell	<b>HILFR05 / HILFR05F</b>	2	\$28.00
10mm Strut Trim Packer	Nitro Gas / Foam Cell	<b>HILFR10 / HILFR10F</b>	2	\$28.00
15mm Strut Trim Packer	Nitro Gas / Foam Cell	<b>HILFR15 / HILFR15F</b>	2	\$28.00

CONTROL ARMS

Pro-Forge Upper Control Arms			<b>UCA050FA</b>	1	\$882.00
------------------------------	--	--	-----------------	---	----------







MN L200  
2009 to 2015

# Mitsubishi Triton

## Product Description

## Part No.

## Qty Req

## Retail ea Inc GST

### REAR SUSPENSION

#### SHOCK ABSORBER

Nitro Gas - Comfort			<b>12636GRC</b>	2	\$153.00
Nitro Gas - Performance			<b>12636GR</b>	2	\$153.00
Nitro Gas - Professional			<b>12636GRP</b>	2	\$153.00
Foam Cell - Comfort			<b>24636FEC</b>	2	\$222.00
Foam Cell - Performance			<b>24636FE</b>	2	\$222.00
Foam Cell - Professional			<b>24636FEP</b>	2	\$222.00
Foam Cell Pro - Comfort			<b>45636FEC</b>	2	\$305.00
Foam Cell Pro - Performance			<b>45636FE</b>	2	\$305.00
Foam Cell Pro - Professional			<b>45636FEP</b>	2	\$305.00

#### LEAF SPRINGS

	Est. Lift	Additional Load			
Light	40mm	0 - 200kg	<b>MITSO41A</b>	2	\$375.00
Medium	40mm	0 - 300kg	<b>MITSO41B</b>	2	\$375.00
Heavy	40mm	300kg - GVM	<b>MITSO41C</b>	2	\$402.00

• Must use Ironman 4x4 bushes.

• Unladen manual vehicles with 2 piece tail shaft may experience vibration in first gear.

#### U-BOLTS

U-Bolt Kit			<b>1102UBK</b>	2	\$42.00
------------	--	--	----------------	---	---------

#### POLYURETHANE SPRING BUSHES

Bush Kit			<b>715TUK</b>	1	\$84.00
----------	--	--	---------------	---	---------

• Not compatible with OEM springs

#### GREASABLE SHACKLES AND PINS

Greasable Shackle			<b>795</b>	2	\$56.00
Non-Greasable Pin			<b>387-1</b>	2	\$28.00

#### HELPER SPRINGS

Load Plus Helper Springs			<b>LP4</b>	1	\$157.00
--------------------------	--	--	------------	---	----------

### SUSPENSION KIT

Light - Nitro Gas		<b>MITSO41AKG</b>	\$1912.00
Light - Foam Cell		<b>MITSO41AKF</b>	\$2106.00
Medium - Nitro Gas		<b>MITSO41BKG</b>	\$1912.00
Medium - Foam Cell		<b>MITSO41BKF</b>	\$2106.00
Medium - Foam Cell Pro		<b>MITSO41BKP</b>	\$3519.00
Heavy - Nitro Gas		<b>MITSO41CKG</b>	\$1967.00
Heavy - Foam Cell		<b>MITSO41CKF</b>	\$2161.00
Heavy - Foam Cell Pro		<b>MITSO41CKP</b>	\$3574.00

• Specify Front Coil Springs when ordering

• Unladen manual vehicles with 2 piece tail shaft may experience vibration in first gear

### SUSPENSION KIT CONTENTS

Shock Absorbers	Leaf Springs	U-Bolts	Polyurethane Spring Bushes
Strut Shock Absorbers	Coil Springs	Upper Control Arms (Foam Cell Pro Kits Only)	



Product Description

Part No.

Qty  
Req

Retail  
ea Inc GST

## ACCESSORIES TO SUIT MITSUBISHI TRITON

### STEEL WINCH BULL BARS

Commercial Deluxe

BBCD016

\$2244.00

Protector - *While Stocks Last*

BBT016

\$2271.00

• Can also be fitted to both 2WD and 4WD models.

### STEEL SIDE STEPS AND RAILS - FITS DUAL CAB AND EXTRA CAB MODELS ONLY

Side Steps and Rails

SSR031

\$1155.00

### LOCKSAFE DRAWER SYSTEMS

Twin Drawers - 1300mm

ITD1300

\$1469.00

Single Drawer - 1300mm

ISD1300

\$891.00

Wing Kit - 1300mm\*

ITDW031

\$351.00

\*Designed to suit factory tubs, will not suit ute liner without modification.

### SNORKEL

ML Triton 2006 to 2009

ISNORKELO20

\$418.00

### LONG RANGE FUEL TANK

125L\* Diesel (Not compatible with factory diff-lock) - Fits Dual Cab only

TANK004

\$1129.00

125L\* Petrol (Not compatible with factory diff-lock) - Fits Dual Cab only

TANK005

\$1129.00

\* Usable volume may differ to the stated tank capacity

• Modification required with factory rear diff-lock.

### UNDERBODY PROTECTION

Engine Bay and Transmission - *While Stocks Last*

IUP010K

\$563.00

Fuel Tank - *While Stocks Last*

IUP010F

\$296.00

• Fuel tank protection plates are not compatible with long range fuel tanks.

### SEAT COVER

Canvas Comfort - Front

ICSC031F

\$401.00

Canvas Comfort - Rear

ICSC031R

\$401.00

### DIFF BREATHER KIT

Diff Breather Kit

IDIFFBRE

\$115.00





ML L200  
2006 to 2009

# Mitsubishi Triton

Product Description

Part No.

Qty  
ReqRetail  
ea Inc GST

## SUSPENSION TO SUIT MITSUBISHI TRITON

### FRONT SUSPENSION

#### SHOCK ABSORBER

Nitro Gas Strut - Performance <sup>1</sup>			<b>12715GR</b>	2	\$222.00
Foam Cell Strut - Performance <sup>1</sup>			<b>24715FE</b>	2	\$250.00
Foam Cell Pro Strut - Performance* (SEE NOTE)			<b>45715FE</b>	2	\$388.00

\*NOTE: MANDATORY FITMENT of UCA050FA and MITS045B /C Coil Springs with 45715FE

<sup>1</sup> Height adjustable with Ironman 4x4 Strut Trim Packers

#### COIL SPRINGS

	Est. Lift	Additional Load			
Standard	0mm	0 - 50kg	<b>MITSO40S</b>	1	\$250.00
Light	25mm	0 - 50kg	<b>MITSO40A</b>	1	\$250.00
Medium	30mm	0 - 80kg	<b>MITSO40B</b>	1	\$250.00
Medium* (SEE NOTE)	50mm	0 - 80kg	<b>MITSO45B *</b>	1	\$250.00
Heavy	30mm	80 - 110kg	<b>MITSO40C</b>	1	\$250.00
Heavy* (SEE NOTE)	50mm	80 - 110kg	<b>MITSO45C *</b>	1	\$250.00

\*NOTE: MANDATORY FITMENT of UCA050FA and 45715FE with (MITSO45B /C) Coil Springs

#### STRUT MOUNTS

Steel Strut Top			<b>ISST010</b>	2	\$97.00
-----------------	--	--	----------------	---	---------

#### TRIM PACKERS

5mm Strut Trim Packer	Nitro Gas / Foam Cell	<b>HILFR05 / HILFR05F</b>	2	\$28.00
10mm Strut Trim Packer	Nitro Gas / Foam Cell	<b>HILFR10 / HILFR10F</b>	2	\$28.00
15mm Strut Trim Packer	Nitro Gas / Foam Cell	<b>HILFR15 / HILFR15F</b>	2	\$28.00

#### CONTROL ARMS

Pro-Forge Upper Control Arms			<b>UCA050FA</b>	1	\$882.00
------------------------------	--	--	-----------------	---	----------

### REAR SUSPENSION

#### SHOCK ABSORBER

Nitro Gas - Comfort			<b>12636GRC</b>	2	\$153.00
Nitro Gas - Performance			<b>12636GR</b>	2	\$153.00
Nitro Gas - Professional			<b>12636GRP</b>	2	\$153.00
Foam Cell - Comfort			<b>24636FEC</b>	2	\$222.00
Foam Cell - Performance			<b>24636FE</b>	2	\$222.00
Foam Cell - Professional			<b>24636FEP</b>	2	\$222.00
Foam Cell Pro - Comfort			<b>45636FEC</b>	2	\$305.00
Foam Cell Pro - Performance			<b>45636FE</b>	2	\$305.00
Foam Cell Pro - Professional			<b>45636FEP</b>	2	\$305.00

#### LEAF SPRINGS

	Est. Lift	Additional Load			
Light	40mm	0 - 200kg	<b>MITSO41A</b>	2	\$375.00
Medium	40mm	0 - 300kg	<b>MITSO41B</b>	2	\$375.00
Heavy	40mm	300kg - GVM	<b>MITSO41C</b>	2	\$402.00

• Must use Ironman 4x4 bushes.

• Unladen manual vehicles with 2 piece tail shaft may experience vibration in first gear.

#### U-BOLTS

U-Bolt Kit			<b>1102UBK</b>	2	\$42.00
------------	--	--	----------------	---	---------

#### POLYURETHANE SPRING BUSHES

Bush Kit			<b>715TUK</b>	1	\$84.00
----------	--	--	---------------	---	---------

• Not compatible with OEM springs

#### GREASABLE SHACKLES AND PINS

Greasable Shackle			<b>795</b>	2	\$56.00
Non-Greasable Pin			<b>387-1</b>	2	\$28.00

#### HELPER SPRINGS

Load Plus Helper Springs			<b>LP4</b>	1	\$157.00
--------------------------	--	--	------------	---	----------

LISTING  
CONTINUED  
OVER THE  
PAGE

# Mitsubishi Triton

ML L200  
2006 to 2009



Product Description

Part No.

Qty  
Req

Retail  
ea Inc GST

## SUSPENSION KIT

Light - Nitro Gas	<b>MITSO41AKG</b>	\$1912.00
Light - Foam Cell	<b>MITSO41AKF</b>	\$2106.00
Medium - Nitro Gas	<b>MITSO41BKG</b>	\$1912.00
Medium - Foam Cell	<b>MITSO41BKF</b>	\$2106.00
Medium - Foam Cell Pro	<b>MITSO41BKP</b>	\$3519.00
Heavy - Nitro Gas	<b>MITSO41CKG</b>	\$1967.00
Heavy - Foam Cell	<b>MITSO41CKF</b>	\$2161.00
Heavy - Foam Cell Pro	<b>MITSO41CKP</b>	\$3574.00

• Specify Front Coil Springs when ordering

• Unladen manual vehicles with 2 piece tail shaft may experience vibration in first gear

## SUSPENSION KIT CONTENTS

Shock Absorbers	Leaf Springs	U-Bolts	Polyurethane Spring Bushes
Strut Shock Absorbers	Coil Springs	Upper Control Arms (Foam Cell Pro Kits Only)	



MK L200  
1996 to 2006

# Mitsubishi Triton

Product Description

Part No.

Qty  
ReqRetail  
ea Inc GST

## SUSPENSION TO SUIT MITSUBISHI TRITON

### FRONT SUSPENSION

#### SHOCK ABSORBER

Nitro Gas - Performance	<b>12087GR</b>	2	\$153.00
Foam Cell - Performance	<b>24087FE</b>	2	\$222.00

#### TORSION BAR

Uprated Torsion Bars	<b>MITSO15C</b>	1	\$416.00
----------------------	-----------------	---	----------

• Minimum 60mm downward suspension travel required after adjustment

#### STEERING DAMPER

Foam Cell	Suits vehicles w/o power steering	<b>3517</b>	1	\$167.00
-----------	-----------------------------------	-------------	---	----------

### REAR SUSPENSION

#### SHOCK ABSORBER

Nitro Gas - Comfort	<b>12698GRC</b>	2	\$153.00
Nitro Gas - Performance	<b>12698GR</b>	2	\$153.00
Nitro Gas - Professional	<b>12698GRP</b>	2	\$153.00
Foam Cell - Comfort	<b>24698FEC</b>	2	\$222.00
Foam Cell - Performance	<b>24698FE</b>	2	\$222.00
Foam Cell - Professional	<b>24698FEP</b>	2	\$222.00

#### LEAF SPRINGS

	Est. Lift	Additional Load			
Medium	40mm	0 - 300kg	<b>MITSO18B</b>	2	\$375.00
Heavy	40mm	300kg - GVM	<b>MITSO18C</b>	2	\$402.00

• Must use Ironman 4x4 bushes

#### U-BOLTS

U-Bolt Kit	<b>451UBK</b>	2	\$42.00
------------	---------------	---	---------

#### POLYURETHANE SPRING BUSHES

Bush Kit	<b>715TUK</b>	1	\$84.00
----------	---------------	---	---------

• Not compatible with OEM springs

#### GREASABLE SHACKLES AND PINS

Greasable Shackle	<b>795</b>	2	\$56.00
Non-Greasable Pin	<b>387-1</b>	2	\$28.00

#### HELPER SPRINGS

Load Plus Helper Springs	<b>LP4</b>	1	\$157.00
--------------------------	------------	---	----------

### SUSPENSION KIT

Medium - Nitro Gas	<b>MITSO15BKG1</b>	\$1940.00
Medium - Foam Cell	<b>MITSO15BKF1</b>	\$2217.00
Heavy - Nitro Gas	<b>MITSO15CKG1</b>	\$1995.00
Heavy - Foam Cell	<b>MITSO15CKF1</b>	\$2272.00

### SUSPENSION KIT CONTENTS

Shock Absorbers	Coil Springs	Polyurethane Spring Bushes	Strut Shock Absorbers
Leaf Springs	U-Bolts	Brake Hose Relocation Kit	





Product Description

Part No.

Qty  
Req

Retail  
ea Inc GST

## SUSPENSION TO SUIT MITSUBISHI TRITON

### FRONT SUSPENSION

#### SHOCK ABSORBER

Nitro Gas - Performance		<b>12082GR</b>	2	\$153.00
Foam Cell - Performance		<b>24082FE</b>	2	\$222.00

#### TORSION BAR

Uprated Torsion Bars		<b>MITS015C</b>	1	\$416.00
----------------------	--	-----------------	---	----------

• Minimum 60mm downward suspension travel required after adjustment

#### STEERING DAMPER

Foam Cell	Suits vehicles w/o power steering	<b>3517</b>	1	\$167.00
-----------	-----------------------------------	-------------	---	----------

### REAR SUSPENSION

#### SHOCK ABSORBER

Nitro Gas - Comfort		<b>12636GRC</b>	2	\$153.00
Nitro Gas - Performance		<b>12636GR</b>	2	\$153.00
Nitro Gas - Professional		<b>12636GRP</b>	2	\$153.00
Foam Cell - Comfort		<b>24636FEC</b>	2	\$222.00
Foam Cell - Performance		<b>24636FE</b>	2	\$222.00
Foam Cell - Professional		<b>24636FEP</b>	2	\$222.00

#### LEAF SPRINGS

	Est. Lift	Additional Load			
Medium	40mm	0 - 300kg	<b>MITS018B</b>	2	\$375.00
Heavy	40mm	300kg - GVM	<b>MITS018C</b>	2	\$402.00

• Must use Ironman 4x4 bushes

#### U-BOLTS

U-Bolt Kit		<b>451UBK</b>	2	\$42.00
------------	--	---------------	---	---------

#### POLYURETHANE SPRING BUSHES

Bush Kit		<b>715TUK</b>	1	\$84.00
----------	--	---------------	---	---------

• Not compatible with OEM springs

#### GREASABLE SHACKLES AND PINS

Greasable Shackle		<b>795</b>	2	\$56.00
Non-Greasable Pin		<b>387-1</b>	2	\$28.00

#### HELPER SPRINGS

Load Plus Helper Springs		<b>LP4</b>	1	\$157.00
--------------------------	--	------------	---	----------

### SUSPENSION KIT

Medium - Nitro Gas		<b>MITS015BKG</b>		\$1940.00
Medium - Foam Cell		<b>MITS015BKF</b>		\$2217.00
Heavy - Nitro Gas		<b>MITS015CKG</b>		\$1995.00
Heavy - Foam Cell		<b>MITS015CKF</b>		\$2272.00

### SUSPENSION KIT CONTENTS

Shock Absorbers	Torsion Bars	Polyurethane Spring Bushes
Leaf Springs	U-Bolts	



L200  
Pre 1993

# Mitsubishi Triton

Product Description

Part No.

Qty  
Req

Retail  
ea Inc GST

## SUSPENSION TO SUIT MITSUBISHI TRITON

### FRONT SUSPENSION

#### SHOCK ABSORBER

Nitro Gas - Performance	<b>12082GR</b>	2	\$153.00
Foam Cell - Performance	<b>24082FE</b>	2	\$222.00

#### TORSION BAR

Uprated Torsion Bars	<b>MITSO13</b>	1	\$416.00
----------------------	----------------	---	----------

• Minimum 60mm downward suspension travel required after adjustment

#### STEERING DAMPER

Foam Cell	Suits vehicles w/o power steering	<b>3517</b>	1	\$167.00
-----------	-----------------------------------	-------------	---	----------

### REAR SUSPENSION

#### SHOCK ABSORBER

Nitro Gas - Comfort	<b>12636GRC</b>	2	\$153.00
Nitro Gas - Performance	<b>12636GR</b>	2	\$153.00
Nitro Gas - Professional	<b>12636GRP</b>	2	\$153.00
Foam Cell - Comfort	<b>24636FEC</b>	2	\$222.00
Foam Cell - Performance	<b>24636FE</b>	2	\$222.00
Foam Cell - Professional	<b>24636FEP</b>	2	\$222.00

#### LEAF SPRINGS

	Est. Lift	Additional Load			
Medium	45mm	0 - 300kg	<b>MITSO18B</b>	2	\$375.00
Heavy	45mm	300kg - GVM	<b>MITSO18C</b>	2	\$402.00

• Must use Ironman 4x4 bushes

#### U-BOLTS

U-Bolt Kit	<b>451UBK</b>	2	\$42.00
------------	---------------	---	---------

#### POLYURETHANE SPRING BUSHES

Bush Kit	<b>715UK</b>	1	\$84.00
----------	--------------	---	---------

#### GREASABLE SHACKLES AND PINS

Greasable Shackle	<b>795</b>	2	\$56.00
Greasable Pin	<b>796</b>	2	\$28.00

#### HELPER SPRINGS

Load Plus Helper Springs	<b>LP4</b>	1	\$157.00
--------------------------	------------	---	----------

### SUSPENSION KIT

Medium - Nitro Gas	<b>MITSO18BKG1</b>	\$1940.00
Medium - Foam Cell	<b>MITSO18BKF1</b>	\$2217.00
Heavy - Nitro Gas	<b>MITSO18CKG1</b>	\$1995.00
Heavy - Foam Cell	<b>MITSO18CKF1</b>	\$2272.00

### SUSPENSION KIT CONTENTS

Shock Absorbers	Torsion Bars	Polyurethane Spring Bushes
Leaf Springs	U-Bolts	



for a full range of accessories visit our website

[www.ironman4x4.com](http://www.ironman4x4.com)



## Nissan Navara

NP300  
2021+ Series 5

Product Description

DATE AVAILABLE

Part No.

Qty  
ReqRetail  
ea Inc GST

## ACCESSORIES TO SUIT NISSAN NAVARA

**STEEL WINCH BULL BARS**

Premium - 60.3mm Tube*	Q1 2022	BBP082	\$2414.00
Commercial Deluxe <sup>Δ</sup>	Q1 2022	BBCD082	\$2244.00

\* Low profile design retains ADAS radar in factory grille

<sup>Δ</sup> Relocates ADAS radar into bull bar**STEEL SIDE STEPS AND RAILS - FITS DUAL CAB MODELS ONLY**

Side Steps	Q1 2022	SS082	\$962.00
Side Rails	Q1 2022	SS082 RAIL	\$317.00
Side Steps and Rails	Q1 2022	SSR082	\$1155.00
Premium Side Steps - 60.3mm Tube	Q1 2022	SSP082	\$1055.00
Premium Side Rails - 60.3mm Tube	Q1 2022	SSP082 RAIL	\$384.00
Premium Side Steps and Rails - 60.3mm Tube	Q1 2022	SSRP082	\$1276.00

SSR082 and SS082 RAIL suit BBCD082 Bull bar. SSRP082 and SSP082 RAIL suit BBP082 bull bar

**TOWING**

Rear Protection Towbar - Full Rear Bumper Replacement	Q1 2022	RTB082	\$1328.00
Towbar Wiring Loom - Plug and Play	Q1 2022	ITBL082	\$445.00

**RECOVERY POINTS - IRONMAN 4X4 BULL BAR ONLY**

Recovery Points - 5000kg Rating (Pair)	Q1 2022	IRP082	\$325.00
--	---------	--------	----------

**CANOPY - PINNACLE 2 FIBREGLASS (SIDE LIFT UP WINDOWS AND CENTRAL LOCKING REAR DOOR) - FITS 4X4 AND 4X2 DUAL CAB MODELS**

Pre-Primed		ICANOPY082-P	\$2899.00*
Black Star (G42)		ICANOPY082-B	\$3399.00
Brilliant Silver (K23)		ICANOPY082-BS	\$3399.00
Stealth Grey (KBY)		ICANOPY082-SG	\$3399.00
Solid White (QM1)		ICANOPY082-SW	\$3399.00
Twilight Grey (K21)		ICANOPY082-TG	\$3399.00
White Pearl (QX1)		ICANOPY082-WP	\$3399.00

**SLIDE-AWAY ROLL UP HARD TONNEAU COVER**

Electric with Remote Control		ISLIDEAWAY082-E	\$2699.00
------------------------------	--	-----------------	-----------

**SEAT COVER**

Canvas Comfort - Front	Q2 2022	ICSC082F	\$401.00
Canvas Comfort - Rear	Q2 2022	ICSC082R	\$401.00

**DIFF BREATHER KIT**

Diff Breather Kit		IDIFFBRE	\$115.00
-------------------	--	----------	----------

LISTING  
CONTINUED  
OVER THE  
PAGE



Product Description

Part No.

Qty  
Req

Retail  
ea Inc GST

## SUSPENSION TO SUIT NISSAN NAVARA

### FRONT SUSPENSION

#### SHOCK ABSORBER

Nitro Gas Strut - Performance			<b>12716GR</b>	2	\$222.00
Foam Cell Strut - Performance			<b>24716FE</b>	2	\$250.00
Foam Cell Pro Strut - Performance			<b>45716FE</b>	2	\$388.00
Foam Cell Pro Strut - Performance - Long Travel* (SEE NOTE)			<b>45716LFE *</b>	2	\$388.00

\*NOTE: MANDATORY FITMENT of Ironman 4x4 UCA048FA is required with Long Travel - Foam Cell Pro

- Height adjustable with Ironman 4x4 Strut Trim Packers
- Foam Cell Pro contains a single adjusting ring for driveshaft clearance

#### COIL SPRINGS

	Est. Lift	Additional Load			
Standard	0mm	0 - 50kg	<b>NISS040A</b>	1	\$250.00
Light	20mm	0 - 50kg	<b>NISS040B</b>	1	\$250.00
Medium	35mm	0 - 80kg	<b>NISS040C</b>	1	\$250.00
Heavy	40mm	50 - 110kg	<b>NISS040D</b>	1	\$250.00

• Series 5 vehicles are produced with a 25mm increased ride height from factory. The resulting lift estimated with Ironman 4x4 suspension will be 25mm less than stated above

#### STRUT MOUNTS

Steel Strut Top			<b>ISST007</b>	2	\$84.00
-----------------	--	--	----------------	---	---------

#### TRIM PACKERS

5mm Strut Trim Packer	Nitro Gas / Foam Cell	<b>HILFR05 / HILFR05F</b>	2	\$28.00
10mm Strut Trim Packer	Nitro Gas / Foam Cell	<b>HILFR10 / HILFR10F</b>	2	\$28.00
15mm Strut Trim Packer	Nitro Gas / Foam Cell	<b>HILFR15 / HILFR15F</b>	2	\$28.00

• ONLY Compatible with Ironman 4x4 Struts (except Pro), lift height subject to 2:1 motion ratio. Unnecessary fitment may lift vehicle too high

#### CONTROL ARMS

Pro-Forge Upper Control Arms			<b>UCA048FA</b>	1	\$882.00
------------------------------	--	--	-----------------	---	----------

### REAR SUSPENSION

#### SHOCK ABSORBER

Nitro Gas - Performance			<b>12728GR</b>	2	\$153.00
Foam Cell - Performance			<b>24728FE</b>	2	\$222.00
Foam Cell - Professional			<b>24728FEP</b>	2	\$222.00
Foam Cell Pro - Comfort			<b>45728FEC</b>	2	\$305.00
Foam Cell Pro - Performance			<b>45728FE</b>	2	\$305.00
Foam Cell Pro - Professional			<b>45728FEP</b>	2	\$305.00

• When fitting Foam Cell Pro shock absorbers to the rear of the vehicle, a small modification may be needed on some vehicles to create clearance between the shock body and the lower shock mount gusset on the differential. Also note the Foam Cell Pro lower eye is offset to assist with clearance.

#### COIL SPRINGS

	Est. Lift	Additional Load			
Light	20mm	0 - 200kg	<b>NISS058A</b>	1	\$250.00
Medium	40mm	0 - 300kg	<b>NISS058B</b>	1	\$250.00
Heavy	40mm	300kg - 600kg	<b>NISS058C</b>	1	\$250.00
Extra Heavy	45mm	600kg - GVM	<b>NISS058D</b>	1	\$250.00

• Series 5 vehicles are produced with a 25mm increased ride height from factory. The resulting lift estimated with Ironman 4x4 suspension will be 25mm less than stated above

#### COIL SPACER

Polyurethane 20mm			<b>NAVR20</b>	2	\$42.00
-------------------	--	--	---------------	---	---------

#### SPACER KIT

Sway Bar and Headlight Bracket Extension Kit			<b>1204K</b>	1	\$97.00
--	--	--	--------------	---	---------

### SUSPENSION KIT

Medium - Nitro Gas	<b>NISS058BKG</b>	\$1344.00
Medium - Foam Cell	<b>NISS058BKF</b>	\$1538.00
Medium - Foam Cell Pro	<b>NISS058BKP</b>	\$1981.00
Heavy - Nitro Gas	<b>NISS058CKG</b>	\$1344.00
Heavy - Foam Cell	<b>NISS058CKF</b>	\$1538.00
Heavy - Foam Cell Pro	<b>NISS058CKP</b>	\$1981.00
Extra Heavy - Nitro Gas	<b>NISS058DKG</b>	\$1344.00
Extra Heavy - Foam Cell	<b>NISS058DKF</b>	\$1538.00
Extra Heavy - Foam Cell Pro	<b>NISS058DKP</b>	\$1981.00

• Specify front Coil Springs when ordering

• Series 5 vehicles are produced with a 25mm increased ride height from factory. The resulting lift estimated with Ironman 4x4 suspension will be 25mm less than stated above

### SUSPENSION KIT CONTENTS

Shock Absorbers  
Coil Springs

Strut Shock Absorbers  
Sway Bar and Headlight Bracket Kit





## Nissan Navara

NP300 (Leaf Springs)  
2021+ Series 5

## Product Description

## Part No.

Qty  
ReqRetail  
ea Inc GST

## SUSPENSION TO SUIT NISSAN NAVARA

## FRONT SUSPENSION

## SHOCK ABSORBER

Nitro Gas Strut - Performance			<b>12716GR</b>	2	\$222.00
Foam Cell Strut - Performance			<b>24716FE</b>	2	\$250.00
Foam Cell Pro Strut - Performance			<b>45716FE</b>	2	\$388.00
Foam Cell Pro Strut - Performance - Long Travel* (SEE NOTE)			<b>45716LFE *</b>	2	\$388.00

\*NOTE: MANDATORY FITMENT of Ironman 4x4 UCA048FA is required with Long Travel - Foam Cell Pro

- Height adjustable with Ironman 4x4 Strut Trim Packers
- Foam Cell Pro contains a single adjusting ring for driveshaft clearance

## COIL SPRINGS

	Est. Lift	Additional Load			
Standard	0mm	0 - 50kg	<b>NISS040A</b>	1	\$250.00
Light	20mm	0 - 50kg	<b>NISS040B</b>	1	\$250.00
Medium	35mm	0 - 80kg	<b>NISS040C</b>	1	\$250.00
Heavy	40mm	50 - 110kg	<b>NISS040D</b>	1	\$250.00

## STRUT MOUNTS

Steel Strut Top			<b>ISST007</b>	2	\$84.00
-----------------	--	--	----------------	---	---------

## TRIM PACKERS

5mm Strut Trim Packer	Nitro Gas / Foam Cell	<b>HILFR05 / HILFR05F</b>	2	\$28.00
10mm Strut Trim Packer	Nitro Gas / Foam Cell	<b>HILFR10 / HILFR10F</b>	2	\$28.00
15mm Strut Trim Packer	Nitro Gas / Foam Cell	<b>HILFR15 / HILFR15F</b>	2	\$28.00

• ONLY Compatible with Ironman 4x4 Struts (Except Pro), lift height subject to 2:1 motion ratio. Unnecessary fitment may lift vehicle too high

## CONTROL ARMS

Pro-Forge Upper Control Arms			<b>UCA048FA</b>	1	\$882.00
------------------------------	--	--	-----------------	---	----------

## REAR SUSPENSION

## SHOCK ABSORBER

Nitro Gas - Comfort			<b>12698GRC</b>	2	\$153.00
Nitro Gas - Performance			<b>12698GR</b>	2	\$153.00
Foam Cell - Comfort			<b>24698FEC</b>	2	\$222.00
Foam Cell - Performance			<b>24698FE</b>	2	\$222.00
Foam Cell - Professional			<b>24698FEP</b>	2	\$222.00
Foam Cell Pro - Comfort			<b>45698FEC</b>	2	\$305.00
Foam Cell Pro - Performance			<b>45698FE</b>	2	\$305.00
Foam Cell Pro - Professional			<b>45698FEP</b>	2	\$305.00

## LEAF SPRINGS

	Est. Lift	Additional Load			
Medium	40mm	0 - 300kg	<b>NISS057B</b>	2	\$375.00
Heavy	40mm	300kg - GVM	<b>NISS057C</b>	2	\$402.00

## U-BOLTS

U-Bolt Kit			<b>1104UBK</b>	2	\$42.00
------------	--	--	----------------	---	---------

## POLYURETHANE SPRING BUSHES

Bush Kit			<b>704TUK</b>	1	\$84.00
----------	--	--	---------------	---	---------

## GREASABLE SHACKLES AND PINS

Greasable Shackle			<b>797-3</b>	2	\$56.00
-------------------	--	--	--------------	---	---------

## HELPER SPRINGS

Load Plus Helper Springs			<b>LP2</b>	1	\$157.00
Add-A-Leaf			<b>ISL6010</b>	1	\$167.00

## SUSPENSION KIT

Medium - Nitro Gas			<b>NISS057BKG</b>		\$1912.00
Medium - Foam Cell			<b>NISS057BKF</b>		\$2106.00
Medium - Foam Cell Pro			<b>NISS057BKP</b>		\$2549.00
Heavy - Nitro Gas			<b>NISS057CKG</b>		\$1967.00
Heavy - Foam Cell			<b>NISS057CKF</b>		\$2161.00
Heavy - Foam Cell Pro			<b>NISS057CKP</b>		\$2605.00

• Specify front Coil Springs when ordering

## SUSPENSION KIT CONTENTS

Shock Absorbers	Coil Springs	Polyurethane Spring Bushes
Leaf Springs	U-Bolts	



## Product Description

## Part No.

Qty  
ReqRetail  
ea Inc GST

## ACCESSORIES TO SUIT NISSAN NAVARA

## STEEL WINCH BULL BARS - THAI BUILT MODEL ONLY (SUITS WIDE BODY)

Commercial	BBC048	\$1648.00*
Commercial Deluxe	BBCD048	\$2244.00*
Polished Alloy	BBA048	\$2794.00
Proguard No Loop	BBT048-NL	\$1855.00
Proguard Single Loop Kit	BB048-SL	\$336.00
Proguard Triple Loop Kit	BB048-TL	\$404.00
Driving Light Patch Loom - Factory LED Headlight models only	IPL048	\$31.00
<i>* Nissan Australia recommend installation of heavy duty front coil springs when installing a bull bar - Aust Only</i>	NISS040C	\$250.00

## STEEL SIDE STEPS AND RAILS - FITS DUAL CAB MODELS ONLY

Side Steps	SS048	\$962.00
Side Rails	SS048 RAIL	\$317.00
Side Steps and Rails	SSR048	\$1155.00

## TOWING

Class 4 Towbar - Compatible with Factory Rear Bumper	TB048	\$581.00
Rear Protection Towbar - Full Rear Bumper Replacement	RTB048	\$1328.00
Rear Protection Towbar Plates (Pair)	RTBPLATE048	\$146.00
Towbar Wiring Loom - Plug and Play	ITBL048	\$276.00

## RECOVERY POINTS - IRONMAN 4X4 BULL BAR ONLY

Recovery Points - 5000kg Rating (Pair)	IRP005	\$217.00
--	--------	----------

## LOCKSAFE DRAWER SYSTEMS - FITS DUAL AND EXTRA CAB

Twin Drawers - 1300mm	ITD1300	\$1469.00
Single Drawer - 1300mm	ISD1300	\$891.00
Wing Kit - 1300mm*	ITDW048	\$351.00

*\*Designed to suit factory tubs, will not suit ute liner without modification.*

## SNORKEL

Suits wide and narrow body 2.3 twin and single turbo diesel	ISNORKEL048	\$418.00
---	-------------	----------

## LONG RANGE FUEL TANK

140L* - Auto/Coil Spring Diesel only	TANK048	\$1129.00
--------------------------------------	---------	-----------

*\* Usable volume may differ to the stated tank capacity*

## PREMIUM UNDERBODY PROTECTION

Engine Bay and Transmission - Series 1	UBP048	\$748.00
Engine Bay and Transmission - Series 2, 3 and 4	UBP048S	\$748.00

## EXHAUST SYSTEM

3" Exhaust Upgrade 2.3L - DPF Back - <i>While Stocks Last</i>	IEX048	\$770.00
---	--------	----------

## CANOPY - ABS PLASTIC (SIDE LIFT UP WINDOWS AND CENTRAL LOCKING REAR DOOR) - FITS 4X4 AND 4X2 DUAL CAB MODELS

White (QM1)	CANOPY013-PW	\$3856.00
Brilliant Silver (K23)	CANOPY013-BS	\$3856.00
White Diamond (QX1)	CANOPY013-WP	\$3856.00
Cosmic Black (G42)	CANOPY013-CB	\$3856.00
ABS Canopy Rack Feet	IRRFETABS14	\$274.00

*• See Page 37 and 38 for 1.4m Roof Rack options and pricing.*

## CANOPY - PINNACLE SMOOTH FINISH FIBREGLASS (SIDE LIFT UP WINDOWS AND CENTRAL LOCKING REAR DOOR) - FITS 4X4 AND 4X2 DUAL CAB MODELS

Pre-Primed	CANFIBRE048-P	\$2899.00*
White (QM1)	CANFIBRE048-PW	\$3399.00
Brilliant Silver (K23)	CANFIBRE048-BS	\$3399.00
Hornet Gold (EAU)	CANFIBRE048-HG	\$3399.00
White Diamond (QX1)	CANFIBRE048-WP	\$3399.00
Cosmic Black (G42)	CANFIBRE048-CB	\$3399.00
Slate Grey (K21)	CANFIBRE048-SG	\$3399.00

*\* Pre-primed canopies, plus colour coding.*

## CANOPY - PINNACLE 2 FIBREGLASS (SIDE LIFT UP WINDOWS AND CENTRAL LOCKING REAR DOOR) - FITS 4X4 AND 4X2 DUAL CAB MODELS

Pre-Primed	ICANOPY048-P	\$2899.00*
Brilliant Silver (K23)	ICANOPY048-BS	\$3399.00
Cosmic Black (G42)	ICANOPY048-CB	\$3399.00
White (QM1)	ICANOPY048-PW	\$3399.00
Slate Grey (K21)	ICANOPY048-SG	\$3399.00
White Diamond (QX1)	ICANOPY048-WP	\$3399.00

## SLIDE-AWAY ROLL UP HARD TONNEAU COVER

Electric with Remote Control	ISLIDEAWAY048-E	\$2599.00
------------------------------	-----------------	-----------

## SEAT COVER

Canvas Comfort - Front	ICSC048F	\$401.00
Canvas Comfort - Rear (Does not suit series 3)	ICSC048R	\$401.00
Canvas Comfort - Rear (Suits series 3)	ICSC048MYR	\$401.00

## DIFF BREATHER KIT

Diff Breather Kit	IDIFFBRE	\$115.00
-------------------	----------	----------



## Nissan Navara

NP300 (Coil Springs)  
2015 to 2020 Series 1 to 5

## Product Description

## Part No.

Qty  
ReqRetail  
ea Inc GST

## SUSPENSION TO SUIT NISSAN NAVARA

## FRONT SUSPENSION

## SHOCK ABSORBER

Nitro Gas Strut - Performance			<b>12716GR</b>	2	\$222.00
Foam Cell Strut - Performance			<b>24716FE</b>	2	\$250.00
Foam Cell Pro Strut - Performance			<b>45716FE</b>	2	\$388.00
Foam Cell Pro Strut - Performance - Long Travel* (SEE NOTE)			<b>45716LFE *</b>	2	\$388.00

\*NOTE: MANDATORY FITMENT of Ironman 4x4 UCA048FA is required with Long Travel - Foam Cell Pro

- Height adjustable with Ironman 4x4 Strut Trim Packers
- Foam Cell Pro contains a single adjusting ring for driveshaft clearance

## COIL SPRINGS

	Est. Lift	Additional Load			
Standard	0mm	0 - 50kg	<b>NISS040A</b>	1	\$250.00
Light	20mm	0 - 50kg	<b>NISS040B</b>	1	\$250.00
Medium	35mm	0 - 80kg	<b>NISS040C</b>	1	\$250.00
Heavy	40mm	50 - 110kg	<b>NISS040D</b>	1	\$250.00

• Series 3+ vehicles are produced with a 25mm increased ride height from factory. The resulting lift estimated with Ironman 4x4 suspension will be 25mm less than stated above

## STRUT MOUNTS

Steel Strut Top			<b>ISST007</b>	2	\$84.00
-----------------	--	--	----------------	---	---------

## TRIM PACKERS

5mm Strut Trim Packer	Nitro Gas / Foam Cell		<b>HILFR05 / HILFR05F</b>	2	\$28.00
10mm Strut Trim Packer	Nitro Gas / Foam Cell		<b>HILFR10 / HILFR10F</b>	2	\$28.00
15mm Strut Trim Packer	Nitro Gas / Foam Cell		<b>HILFR15 / HILFR15F</b>	2	\$28.00

• ONLY Compatible with Ironman 4x4 Struts (except Pro), lift height subject to 2:1 motion ratio. Unnecessary fitment may lift vehicle too high

## CONTROL ARMS

Pro-Forge Upper Control Arms			<b>UCA048FA</b>	1	\$882.00
------------------------------	--	--	-----------------	---	----------

## REAR SUSPENSION

## SHOCK ABSORBER

Nitro Gas - Performance			<b>12728GR</b>	2	\$153.00
Foam Cell - Performance			<b>24728FE</b>	2	\$222.00
Foam Cell - Professional			<b>24728FEP</b>	2	\$222.00
Foam Cell Pro - Comfort			<b>45728FEC</b>	2	\$305.00
Foam Cell Pro - Performance			<b>45728FE</b>	2	\$305.00
Foam Cell Pro - Professional			<b>45728FEP</b>	2	\$305.00

• When fitting Foam Cell Pro shock absorbers to the rear of the vehicle, a small modification may be needed on some vehicles to create clearance between the shock body and the lower shock mount gusset on the differential. Also note the Foam Cell Pro lower eye is offset to assist with clearance.

## COIL SPRINGS

	Est. Lift	Additional Load			
Light	20mm	0 - 200kg	<b>NISS058A</b>	1	\$250.00
Medium	40mm	0 - 300kg	<b>NISS058B</b>	1	\$250.00
Heavy	40mm	300kg - 600kg	<b>NISS058C</b>	1	\$250.00
Extra Heavy	45mm	600kg - GVM	<b>NISS058D</b>	1	\$250.00

• Series 3+ vehicles are produced with a 25mm increased ride height from factory. The resulting lift estimated with Ironman 4x4 suspension will be 25mm less than stated above

## COIL SPACER

Polyurethane 20mm			<b>NAVR20</b>	2	\$42.00
-------------------	--	--	---------------	---	---------

## SPACER KIT

Sway Bar and Headlight Bracket Extension Kit			<b>1204K</b>	1	\$97.00
--	--	--	--------------	---	---------

## SUSPENSION KIT

Medium - Nitro Gas			<b>NISS058BKG</b>		\$1344.00
Medium - Foam Cell			<b>NISS058BKF</b>		\$1538.00
Medium - Foam Cell Pro			<b>NISS058BKP</b>		\$1981.00
Heavy - Nitro Gas			<b>NISS058CKG</b>		\$1344.00
Heavy - Foam Cell			<b>NISS058CKF</b>		\$1538.00
Heavy - Foam Cell Pro			<b>NISS058CKP</b>		\$1981.00
Extra Heavy - Nitro Gas			<b>NISS058DKG</b>		\$1344.00
Extra Heavy - Foam Cell			<b>NISS058DKF</b>		\$1538.00
Extra Heavy - Foam Cell Pro			<b>NISS058DKP</b>		\$1981.00

• Specify front Coil Springs when ordering

• Series 3+ vehicles are produced with a 25mm increased ride height from factory. The resulting lift estimated with Ironman 4x4 suspension will be 25mm less than stated above

## SUSPENSION KIT CONTENTS

Shock Absorbers

Strut Shock Absorbers

Coil Springs

Sway Bar and Headlight Bracket Kit



Product Description

Part No.

Qty  
Req

Retail  
ea Inc GST

## SUSPENSION TO SUIT NISSAN NAVARA

### FRONT SUSPENSION

#### SHOCK ABSORBER

Nitro Gas Strut - Performance			<b>12716GR</b>	2	\$222.00
Foam Cell Strut - Performance			<b>24716FE</b>	2	\$250.00
Foam Cell Pro Strut - Performance			<b>45716FE</b>	2	\$388.00
Foam Cell Pro Strut - Performance - Long Travel* <b>(SEE NOTE)</b>			<b>45716LFE *</b>	2	\$388.00

**\*NOTE: MANDATORY FITMENT** of Ironman 4x4 UCA048FA is required with Long Travel - Foam Cell Pro

• Height adjustable with Ironman 4x4 Strut Trim Packers

• Foam Cell Pro contains a single adjusting ring for driveshaft clearance

#### COIL SPRINGS

	Est. Lift	Additional Load			
Standard	0mm	0 - 50kg	<b>NISS040A</b>	1	\$250.00
Light	20mm	0 - 50kg	<b>NISS040B</b>	1	\$250.00
Medium	35mm	0 - 80kg	<b>NISS040C</b>	1	\$250.00
Heavy	40mm	50 - 110kg	<b>NISS040D</b>	1	\$250.00

#### STRUT MOUNTS

Steel Strut Top			<b>ISST007</b>	2	\$84.00
-----------------	--	--	----------------	---	---------

#### TRIM PACKERS

5mm Strut Trim Packer	Nitro Gas / Foam Cell	<b>HILFR05 / HILFR05F</b>	2	\$28.00
10mm Strut Trim Packer	Nitro Gas / Foam Cell	<b>HILFR10 / HILFR10F</b>	2	\$28.00
15mm Strut Trim Packer	Nitro Gas / Foam Cell	<b>HILFR15 / HILFR15F</b>	2	\$28.00

• ONLY Compatible with Ironman 4x4 Struts (Except Pro), lift height subject to 2:1 motion ratio. Unnecessary fitment may lift vehicle too high

#### CONTROL ARMS

Pro-Forge Upper Control Arms			<b>UCA048FA</b>	1	\$882.00
------------------------------	--	--	-----------------	---	----------

### REAR SUSPENSION

#### SHOCK ABSORBER

Nitro Gas - Comfort			<b>12698GRC</b>	2	\$153.00
Nitro Gas - Performance			<b>12698GR</b>	2	\$153.00
Foam Cell - Comfort			<b>24698FEC</b>	2	\$222.00
Foam Cell - Performance			<b>24698FE</b>	2	\$222.00
Foam Cell - Professional			<b>24698FEP</b>	2	\$222.00
Foam Cell Pro - Comfort			<b>45698FEC</b>	2	\$305.00
Foam Cell Pro - Performance			<b>45698FE</b>	2	\$305.00
Foam Cell Pro - Professional			<b>45698FEP</b>	2	\$305.00

#### LEAF SPRINGS

	Est. Lift	Additional Load			
Medium	40mm	0 - 300kg	<b>NISS057B</b>	2	\$375.00
Heavy	40mm	300kg - GVM	<b>NISS057C</b>	2	\$402.00

#### U-BOLTS

U-Bolt Kit			<b>1104UBK</b>	2	\$42.00
------------	--	--	----------------	---	---------

#### POLYURETHANE SPRING BUSHES

Bush Kit			<b>704TUK</b>	1	\$84.00
----------	--	--	---------------	---	---------

#### GREASABLE SHACKLES AND PINS

Greasable Shackle			<b>797-3</b>	2	\$56.00
-------------------	--	--	--------------	---	---------

#### HELPER SPRINGS

Load Plus Helper Springs			<b>LP2</b>	1	\$157.00
Add-A-Leaf			<b>ISL6010</b>	1	\$167.00

### SUSPENSION KIT

Medium - Nitro Gas		<b>NISS057BKG</b>	\$1912.00
Medium - Foam Cell		<b>NISS057BKF</b>	\$2106.00
Medium - Foam Cell Pro		<b>NISS057BKP</b>	\$2549.00
Heavy - Nitro Gas		<b>NISS057CKG</b>	\$1967.00
Heavy - Foam Cell		<b>NISS057CKF</b>	\$2161.00
Heavy - Foam Cell Pro		<b>NISS057CKP</b>	\$2605.00

• Specify front Coil Springs when ordering

### SUSPENSION KIT CONTENTS

Shock Absorbers	Coil Springs	Polyurethane Spring Bushes
Leaf Springs	U-Bolts	

D40  
2005+

## Nissan Navara

Product Description

Part No.

Qty  
ReqRetail  
ea Inc GST

## ACCESSORIES TO SUIT NISSAN NAVARA

**STEEL WINCH BULL BARS - RECESSED LINE IN OE BUMPER BAR AND THAI BUILT VEHICLES WITH SMOOTH BUMPER**

Commercial Deluxe	BBCD012	\$2244.00
Protector - <i>While Stocks Last</i>	BBT012	\$2271.00

- Can also be fitted to both 2WD and 4WD models.

**STEEL WINCH BULL BARS - SMOOTH OE BUMPER BAR EXCEPT THAI BUILT VEHICLES**

Commercial Deluxe	BBCD042	\$2244.00
-------------------	---------	-----------

- Can also be fitted to both 2WD and 4WD models.
- STX Spain Built 2010+ - Fits 440(4Cyl) and 550 (V6) Smooth Bumper

**STEEL SIDE STEPS AND RAILS - THAI BUILT DUAL CAB MODEL**

Side Steps	SS007	\$962.00
Side Steps and Rails	SSR003	\$1155.00

**STEEL SIDE STEPS AND RAILS - SPAIN BUILT 2010+ DUAL CAB MODEL**

Side Steps	SS042	\$962.00
Side Steps and Rails	SSR042	\$1155.00

**RECOVERY POINTS - IRONMAN 4X4 BULL BAR ONLY**

Recovery Points - 5000kg Rating (Pair)	IRP005	\$217.00
--	--------	----------

**LOCKSAFE DRAWER SYSTEMS**

Twin Drawers - 1300mm	ITD1300	\$1469.00
Single Drawer - 1300mm	ISD1300	\$891.00
Wing Kit - 1300mm (ST 2010+)*	ITDW028	\$351.00
Wing Kit - 1300mm (STX, 2006+ Spain built)*	ITDW029	\$351.00

\*Designed to suit factory tubs, will not suit ute liner without modification.

**SNORKEL**

D40 Navara 2005+ - Not including RX models	ISNORKE019	\$418.00
--	------------	----------

- Not compatible with RX models.

**EXHAUST SYSTEM**

BigBore Navara D40 550 1/2011+, V6 Turbo Diesel - <i>While Stocks Last</i>	IEXHAUST012	\$1301.00
--	-------------	-----------

- Fits Automatic Transmission.

**LONG RANGE FUEL TANK**

Spain Built 145L* Dual Cab - Diesel only	TANK003	\$1129.00
Thai Built 145L* Dual Cab - Diesel only (includes adaptor kit)	TANK003T	\$1129.00

\* Usable volume may differ to the stated tank capacity

**UNDERBODY PROTECTION**

Engine Bay, Radiator* and Transmission - <i>While Stocks Last</i>	IUP007K	\$563.00
Fuel Tank - <i>While Stocks Last</i>	IUP007F	\$296.00

\* IMPORTANT - Radiator plate ONLY suitable for Spain Built Vehicle. Does not fit vehicles with bull bar fitted.

- Fuel tank protection plates are not compatible with long range fuel tanks.

**SEAT COVER**

Canvas Comfort - Front	ICSC042F	\$401.00
Canvas Comfort - Rear	ICSC042R	\$401.00

**DIFF BREATHER KIT**

Diff Breather Kit	IDIFFBRE	\$115.00
-------------------	----------	----------

LISTING  
CONTINUED  
OVER THE  
PAGE





Product Description

Part No.

Qty  
Req

Retail  
ea Inc GST

## SUSPENSION TO SUIT NISSAN NAVARA

### FRONT SUSPENSION

#### SHOCK ABSORBER

Nitro Gas Strut - Performance		<b>12716GR</b>	2	\$222.00
Foam Cell Strut - Performance		<b>24716FE</b>	2	\$250.00
Foam Cell Pro Strut - Performance		<b>45716FE</b>	2	\$388.00
Foam Cell Pro Strut - Performance - Long Travel* (SEE NOTE)		<b>45716LFE *</b>	2	\$388.00

\*NOTE: MANDATORY FITMENT of Ironman 4x4 UCA048FA is required with Long Travel - Foam Cell Pro

- Height adjustable with Ironman 4x4 Strut Trim Packers
- Foam Cell Pro contains a single adjusting ring for driveshaft clearance

#### COIL SPRINGS

	Est. Lift	Additional Load			
Medium	35mm	0 - 50kg	<b>NISS040C</b>	1	\$250.00
Heavy	35mm	50 - 110kg	<b>NISS040D</b>	1	\$250.00

#### STRUT MOUNTS

Steel Strut Top		<b>ISST007</b>	2	\$84.00
-----------------	--	----------------	---	---------

#### TRIM PACKERS

5mm Strut Trim Packer	Nitro Gas / Foam Cell	<b>HILFR05 / HILFR05F</b>	2	\$28.00
10mm Strut Trim Packer	Nitro Gas / Foam Cell	<b>HILFR10 / HILFR10F</b>	2	\$28.00
15mm Strut Trim Packer	Nitro Gas / Foam Cell	<b>HILFR15 / HILFR15F</b>	2	\$28.00

• ONLY Compatible with Ironman 4x4 Struts (Except Pro), lift height subject to 2:1 motion ratio. Unnecessary fitment may lift vehicle too high

#### CONTROL ARMS

Pro-Forge Upper Control Arms		<b>UCA048FA</b>	1	\$882.00
------------------------------	--	-----------------	---	----------

### REAR SUSPENSION

#### SHOCK ABSORBER

Nitro Gas - Performance		<b>12717GR</b>	2	\$153.00
Foam Cell - Performance		<b>24717FE</b>	2	\$222.00
Foam Cell - Professional		<b>24717FEP</b>	2	\$222.00
Foam Cell Pro - Performance		<b>45717FE</b>	2	\$305.00
Foam Cell Pro - Professional		<b>45717FEP</b>	2	\$305.00

#### LEAF SPRINGS

	Est. Lift	Additional Load			
Medium	40mm	0 - 300kg	<b>NISS041B</b>	2	\$375.00
Heavy	40mm	300 - 500kg	<b>NISS041C</b>	2	\$402.00
Extra Heavy	40mm	500kg - GVM	<b>NISS041D</b>	2	\$402.00

#### U-BOLTS

U-Bolt Kit	Suits NISS041B and NISS041C	<b>437UBK</b>	2	\$42.00
U-Bolt Kit Extra Long	Suits NISS041D	<b>437UBKL</b>	2	\$42.00

#### POLYURETHANE SPRING BUSHES

Bush Kit		<b>769UK</b>	1	\$84.00
----------	--	--------------	---	---------

#### GREASABLE SHACKLES AND PINS

Greasable Shackle		<b>797-1</b>	2	\$56.00
-------------------	--	--------------	---	---------

#### AXLE PROTECTION

ABS Wire and Axle Shield		<b>IAP001</b>	1	\$97.00
--------------------------	--	---------------	---	---------

#### HELPER SPRINGS

Load Plus Helper Springs		<b>LP2</b>	1	\$157.00
Add-A-Leaf		<b>ISL6010</b>	1	\$167.00

### SUSPENSION KIT

Medium - Nitro Gas		<b>NISS041BKG1</b>		\$1912.00
Medium - Foam Cell		<b>NISS041BKF1</b>		\$2106.00
Medium - Foam Cell Pro		<b>NISS041BKP1</b>		\$2549.00
Heavy - Nitro Gas		<b>NISS041CKG1</b>		\$1967.00
Heavy - Foam Cell		<b>NISS041CKF1</b>		\$2161.00
Heavy - Foam Cell Pro		<b>NISS041CKP1</b>		\$2605.00
Extra Heavy - Nitro Gas		<b>NISS041DKG1</b>		\$1967.00
Extra Heavy - Foam Cell		<b>NISS041DKF1</b>		\$2161.00
Extra Heavy - Foam Cell Pro		<b>NISS041DKP1</b>		\$2605.00

• Specify front Coil Springs when ordering

### SUSPENSION KIT CONTENTS

Shock Absorbers	Coil Springs	Polyurethane Spring Bushes
Leaf Springs	U-Bolts	Strut Shock Absorbers





D40 (4cyl Diesel and V6 Petrol)  
2005+

# Nissan Navara

Product Description

Part No.

Qty  
ReqRetail  
ea Inc GST

## SUSPENSION TO SUIT NISSAN NAVARA

### FRONT SUSPENSION

#### SHOCK ABSORBER

Nitro Gas Strut - Performance			<b>12716GR</b>	2	\$222.00
Foam Cell Strut - Performance			<b>24716FE</b>	2	\$250.00
Foam Cell Pro Strut - Performance			<b>45716FE</b>	2	\$388.00
Foam Cell Pro Strut - Performance - Long Travel* ( <b>SEE NOTE</b> )			<b>45716LFE *</b>	2	\$388.00

\*NOTE: MANDATORY FITMENT of Ironman 4x4 UCA048FA is required with Long Travel - Foam Cell Pro

- Height adjustable with Ironman 4x4 Strut Trim Packers
- Foam Cell Pro contains a single adjusting ring for driveshaft clearance

#### COIL SPRINGS

	Est. Lift	Additional Load			
Medium	35mm	0 - 50kg	<b>NISS040B</b>	1	\$250.00
Heavy	35mm	50 - 110kg	<b>NISS040C</b>	1	\$250.00

#### STRUT MOUNTS

Steel Strut Top			<b>ISST007</b>	2	\$84.00
-----------------	--	--	----------------	---	---------

#### TRIM PACKERS

5mm Strut Trim Packer	Nitro Gas / Foam Cell	<b>HILFR05 / HILFR05F</b>	2	\$28.00
10mm Strut Trim Packer	Nitro Gas / Foam Cell	<b>HILFR10 / HILFR10F</b>	2	\$28.00
15mm Strut Trim Packer	Nitro Gas / Foam Cell	<b>HILFR15 / HILFR15F</b>	2	\$28.00

• ONLY Compatible with Ironman 4x4 Struts (Except Pro), lift height subject to 2:1 motion ratio. Unnecessary fitment may lift vehicle too high

#### CONTROL ARMS

Pro-Forge Upper Control Arms			<b>UCA048FA</b>	1	\$882.00
------------------------------	--	--	-----------------	---	----------

### REAR SUSPENSION

#### SHOCK ABSORBER

Nitro Gas - Performance			<b>12717GR</b>	2	\$153.00
Foam Cell - Performance			<b>24717FE</b>	2	\$222.00
Foam Cell - Professional			<b>24717FEP</b>	2	\$222.00
Foam Cell Pro - Performance			<b>45717FE</b>	2	\$305.00
Foam Cell Pro - Professional			<b>45717FEP</b>	2	\$305.00

#### LEAF SPRINGS

	Est. Lift	Additional Load			
Medium	40mm	0 - 300kg	<b>NISS041B</b>	2	\$375.00
Heavy	40mm	300 - 500kg	<b>NISS041C</b>	2	\$402.00
Extra Heavy	40mm	500kg - GVM	<b>NISS041D</b>	2	\$402.00

#### U-BOLTS

U-Bolt Kit	Suits NISS041B and NISS041C	<b>437UBK</b>	2	\$42.00
U-Bolt Kit Extra Long	Suits NISS041D	<b>437UBKL</b>	2	\$42.00

#### POLYURETHANE SPRING BUSHES

Bush Kit		<b>769UK</b>	1	\$84.00
----------	--	--------------	---	---------

#### GREASABLE SHACKLES AND PINS

Greasable Shackle		<b>797-1</b>	2	\$56.00
-------------------	--	--------------	---	---------

#### AXLE PROTECTION

ABS Wire and Axle Shield		<b>IAP001</b>	1	\$97.00
--------------------------	--	---------------	---	---------

#### HELPER SPRINGS

Load Plus Helper Springs		<b>LP2</b>	1	\$157.00
Add-A-Leaf		<b>ISL6010</b>	1	\$167.00

### SUSPENSION KIT

Medium - Nitro Gas	<b>NISS041BKG</b>	\$1804.00
Medium - Foam Cell	<b>NISS041BKF</b>	\$2106.00
Medium - Foam Cell Pro	<b>NISS041BKP</b>	\$2549.00
Heavy - Nitro Gas	<b>NISS041CKG</b>	\$1967.00
Heavy - Foam Cell	<b>NISS041CKF</b>	\$2161.00
Heavy - Foam Cell Pro	<b>NISS041CKP</b>	\$2605.00
Extra Heavy - Nitro Gas	<b>NISS041DKG</b>	\$1967.00
Extra Heavy - Foam Cell	<b>NISS041DKF</b>	\$2161.00
Extra Heavy - Foam Cell Pro	<b>NISS041DKP</b>	\$2605.00

• Specify front Coil Springs when ordering

### SUSPENSION KIT CONTENTS

Shock Absorbers  
Leaf Springs

Coil Springs  
U-Bolts

Polyurethane Spring Bushes  
Strut Shock Absorbers



# Nissan Navara

D22  
2002+



Product Description

Part No.

Qty  
Req

Retail  
ea Inc GST

## ACCESSORIES TO SUIT NISSAN NAVARA

### STEEL WINCH BULL BARS

Commercial Deluxe

**BBCD013**

\$2244.00

Protector - *While Stocks Last*

**BBT013**

\$2271.00

• *Can also be fitted to both 2WD and 4WD models.*

### LOCKSAFE DRAWER SYSTEMS

Twin Drawer - 1300mm

**ITD1300**

\$1469.00

Single Drawer - 1300mm

**ISD1300**

\$891.00

Wing Kit - 1300mm (2002 to 2007)\*

**ITDW025**

\$351.00

Wing Kit - 1300mm (2007+)\*

**ITDW026**

\$351.00

*\*Designed to suit factory tubs, will not suit ute liner without modification.*

### EXHAUST SYSTEM

BigBore D22 Navara 2.5L Diesel Only - *While Stocks Last*

**IEXHAUST011**

\$1301.00

### UNDERBODY PROTECTION

Engine Bay and Transmission - Diesel only - *While Stocks Last*

**IUP006K**

\$369.00

### DIFF BREATHER KIT

Diff Breather Kit

**IDIFFBRE**

\$115.00



D22 / NP300 (Torsion Bar)  
1997+

**SUSPENSION TO SUIT**

# Nissan Navara

Product Description

Part No.

Qty  
Req

Retail  
ea Inc GST

## SUSPENSION TO SUIT NISSAN NAVARA

### FRONT SUSPENSION

#### SHOCK ABSORBER

Nitro Gas - Performance		<b>12791GR</b>	2	\$153.00
-------------------------	--	----------------	---	----------

• Upper control arm may contact shock absorber, grind away material on control arm for clearance

#### TORSION BAR

Uprated Torsion Bars		<b>NISS025</b>	1	\$416.00
----------------------	--	----------------	---	----------

• Minimum 60mm downward suspension travel required after adjustment

### REAR SUSPENSION

#### SHOCK ABSORBER

Nitro Gas - Comfort		<b>12636GRC</b>	2	\$153.00
Nitro Gas - Performance		<b>12636GR</b>	2	\$153.00
Nitro Gas - Professional		<b>12636GRP</b>	2	\$153.00

#### LEAF SPRINGS EST. LIFT ADDITIONAL LOAD

Light - Drivers Side	40mm	0 - 100kg	<b>NISS014AD/S</b>	1	\$375.00
Light - Near Side	40mm	0 - 100kg	<b>NISS014AN/S</b>	1	\$375.00
Medium - Drivers Side	40mm	0 - 250kg	<b>NISS014BD/S</b>	1	\$375.00
Medium - Near Side	40mm	0 - 250kg	<b>NISS014BN/S</b>	1	\$375.00
Heavy - Drivers Side	40mm	250kg - GVM	<b>NISS014CD/S</b>	1	\$402.00
Heavy - Near Side	40mm	250kg - GVM	<b>NISS014CN/S</b>	1	\$402.00

#### U-BOLTS

U-Bolt Kit		<b>788UBK</b>	2	\$42.00
------------	--	---------------	---	---------

#### POLYURETHANE SPRING BUSHES

Bush Kit		<b>704UK</b>	1	\$84.00
----------	--	--------------	---	---------

#### GREASABLE SHACKLES AND PINS

Greasable Shackle		<b>797</b>	2	\$70.00
Greasable Pin		<b>798</b>	2	\$28.00

#### HELPER SPRINGS

Load Plus Helper Springs		<b>LP3</b>	1	\$157.00
Add-A-Leaf		<b>ISL6010</b>	1	\$167.00

### SUSPENSION KIT

Light - Nitro Gas		<b>NISS025AKG</b>		\$1940.00
Medium - Nitro Gas		<b>NISS025BKG</b>		\$1940.00
Heavy - Nitro Gas		<b>NISS025CKG</b>		\$1995.00

### SUSPENSION KIT CONTENTS

Shock Absorbers	Torsion Bars	Polyurethane Spring Bushes
Leaf Springs	U-Bolts	

# Nissan Navara

D21  
1985 to 1996



Product Description

Part No.

Qty  
Req

Retail  
ea Inc GST

## SUSPENSION TO SUIT NISSAN NAVARA

### FRONT SUSPENSION

#### SHOCK ABSORBER

Nitro Gas - Performance	<b>12087GR</b>	2	\$153.00
Foam Cell - Performance	<b>24087FE</b>	2	\$222.00

#### TORSION BAR

Up-rated Torsion Bars	<b>NISS013</b>	1	\$416.00
-----------------------	----------------	---	----------

• Minimum 60mm downward suspension travel required after adjustment

### REAR SUSPENSION

#### SHOCK ABSORBER

Nitro Gas - Comfort	<b>12636GRC</b>	2	\$153.00
Nitro Gas - Performance	<b>12636GR</b>	2	\$153.00
Nitro Gas - Professional	<b>12636GRP</b>	2	\$153.00
Foam Cell - Comfort	<b>24636FEC</b>	2	\$222.00
Foam Cell - Performance	<b>24636FE</b>	2	\$222.00
Foam Cell - Professional	<b>24636FEP</b>	2	\$222.00

#### LEAF SPRINGS EST. LIFT ADDITIONAL LOAD

Light - Drivers Side	40mm	0 - 100kg	<b>NISS014AD/S</b>	1	\$375.00
Light - Near Side	40mm	0 - 100kg	<b>NISS014AN/S</b>	1	\$375.00
Medium - Drivers Side	40mm	0 - 250kg	<b>NISS014BD/S</b>	1	\$375.00
Medium - Near Side	40mm	0 - 250kg	<b>NISS014BN/S</b>	1	\$375.00
Heavy - Drivers Side	40mm	250kg - GVM	<b>NISS014CD/S</b>	1	\$402.00
Heavy - Near Side	40mm	250kg - GVM	<b>NISS014CN/S</b>	1	\$402.00

#### U-BOLTS

U-Bolt Kit	<b>788UBK</b>	2	\$42.00
------------	---------------	---	---------

#### POLYURETHANE SPRING BUSHES

Bush Kit	<b>704UK</b>	1	\$84.00
----------	--------------	---	---------

#### GREASABLE SHACKLES AND PINS

Greasable Shackle	<b>797</b>	2	\$70.00
Greasable Pin	<b>798</b>	2	\$28.00

#### HELPER SPRINGS

Load Plus Helper Springs	<b>LP3</b>	1	\$157.00
Add-A-Leaf	<b>ISL6010</b>	1	\$167.00

### SUSPENSION KIT

Light - Nitro Gas	<b>NISS014AKG</b>	\$1940.00
Light - Foam Cell	<b>NISS014AKF</b>	\$2217.00
Medium - Nitro Gas	<b>NISS014BKG</b>	\$1940.00
Medium - Foam Cell	<b>NISS014BKF</b>	\$2217.00
Heavy - Nitro Gas	<b>NISS014CKG</b>	\$1967.00
Heavy - Foam Cell	<b>NISS014CKF</b>	\$2245.00

### SUSPENSION KIT CONTENTS

Shock Absorbers	Torsion Bars	Polyurethane Spring Bushes
Leaf Springs	U-Bolts	





Pre 2005

SUSPENSION TO SUIT

# Nissan Paladin

Product Description

Part No.

Qty  
Req

Retail  
ea Inc GST

## SUSPENSION TO SUIT NISSAN PALADIN

### FRONT SUSPENSION

#### SHOCK ABSORBER

Nitro Gas - Performance	<b>12791GR</b>	2	\$153.00
-------------------------	----------------	---	----------

#### TORSION BAR

Uprated Torsion Bars	<b>NISS048</b>	1	\$416.00
----------------------	----------------	---	----------

• Minimum 60mm downward suspension travel required after adjustment

### REAR SUSPENSION

#### SHOCK ABSORBER

Nitro Gas - Comfort	<b>12698GRC</b>	2	\$153.00
---------------------	-----------------	---	----------

Nitro Gas - Performance	<b>12698GR</b>	2	\$153.00
-------------------------	----------------	---	----------

Foam Cell - Comfort	<b>24698FEC</b>	2	\$222.00
---------------------	-----------------	---	----------

Foam Cell - Performance	<b>24698FE</b>	2	\$222.00
-------------------------	----------------	---	----------

Foam Cell - Professional	<b>24698FEP</b>	2	\$222.00
--------------------------	-----------------	---	----------

#### LEAF SPRINGS EST. LIFT ADDITIONAL LOAD

Medium	40mm	0 - 250kg	<b>NISS049B</b>	2	\$375.00
--------	------	-----------	-----------------	---	----------

#### U-BOLTS

U-Bolt Kit	<b>654UBK</b>	2	\$42.00
------------	---------------	---	---------

#### POLYURETHANE SPRING BUSHES

Bush Kit	<b>769UKL</b>	1	\$84.00
----------	---------------	---	---------

#### GREASABLE SHACKLES AND PINS

Greasable Shackle	<b>797-2</b>	2	\$56.00
-------------------	--------------	---	---------

Greasable Pin	<b>798</b>	2	\$28.00
---------------	------------	---	---------

#### HELPER SPRINGS

Load Plus Helper Springs	<b>LP2</b>	1	\$157.00
--------------------------	------------	---	----------

Add-A-Leaf	<b>ISL6010</b>	1	\$167.00
------------	----------------	---	----------

### SUSPENSION KIT

Medium - Nitro Gas	<b>NISS049BKG</b>		\$2051.00
--------------------	-------------------	--	-----------

### SUSPENSION KIT CONTENTS

Shock Absorbers

Shackles

Polyurethane Spring Bushes

Leaf Springs

U-Bolts

# Nissan Pathfinder

R51  
2005 to 2013



Product Description

Part No.

Qty  
Req

Retail  
ea Inc GST

## ACCESSORIES TO SUIT NISSAN PATHFINDER

### STEEL WINCH BULL BARS - RECESSED LINE IN OE BUMPER BAR AND THAI VEHICLES WITH SMOOTH BUMPER

Commercial Deluxe	<b>BBCD012</b>	\$2244.00
Protector - <i>While Stocks Last</i>	<b>BBT012</b>	\$2271.00

### STEEL WINCH BULL BARS - SMOOTH OE BUMPER BAR EXCEPT THAI BUILT VEHICLES

Commercial Deluxe	<b>BBCD042</b>	\$2244.00
• <i>STX Spain Built 2010+ - Fits 2012 V6 model only</i>		

### SNORKEL

R51 Pathfinder	<b>ISNORKE019</b>	\$418.00
----------------	-------------------	----------

### UNDERBODY PROTECTION

Engine - <i>While Stocks Last</i>	<b>IUP007E</b>	\$200.00
-----------------------------------	----------------	----------

### DIFF BREATHER KIT

Diff Breather Kit	<b>IDIFFBRE</b>	\$115.00
-------------------	-----------------	----------



R51 (V6 Diesel)  
7/2005+

# Nissan Pathfinder

Product Description

Part No.

Qty  
ReqRetail  
ea Inc GST

## SUSPENSION TO SUIT NISSAN PATHFINDER

### FRONT SUSPENSION

#### SHOCK ABSORBER

Nitro Gas Strut - Performance			<b>12716GR</b>	2	\$222.00
Foam Cell Strut - Performance			<b>24716FE</b>	2	\$250.00
Foam Cell Pro Strut - Performance			<b>45716FE</b>	2	\$388.00
Foam Cell Pro Strut - Performance - Long Travel* <b>(SEE NOTE)</b>			<b>45716LFE *</b>	2	\$388.00

\*NOTE: MANDATORY FITMENT of Ironman 4x4 UCA048FA is required with Long Travel - Foam Cell Pro

- Height adjustable with Ironman 4x4 Strut Trim Packers
- Foam Cell Pro contains a single adjusting ring for driveshaft clearance

#### COIL SPRINGS

	Est. Lift	Additional Load			
Medium	35mm	0 - 50kg	<b>NISS040C</b>	1	\$250.00
Heavy	35mm	50 - 110kg	<b>NISS040D</b>	1	\$250.00

#### STRUT MOUNTS

Steel Strut Top			<b>ISST007</b>	2	\$84.00
-----------------	--	--	----------------	---	---------

#### TRIM PACKERS

5mm Strut Trim Packer	Nitro Gas / Foam Cell	<b>HILFR05 / HILFR05F</b>	2	\$28.00
10mm Strut Trim Packer	Nitro Gas / Foam Cell	<b>HILFR10 / HILFR10F</b>	2	\$28.00
15mm Strut Trim Packer	Nitro Gas / Foam Cell	<b>HILFR15 / HILFR15F</b>	2	\$28.00

• ONLY Compatible with Ironman 4x4 Struts (Except Pro), lift height subject to 2:1 motion ratio. Unnecessary fitment may lift vehicle too high

#### CONTROL ARMS

Pro-Forge Upper Control Arms			<b>UCA048FA</b>	1	\$882.00
------------------------------	--	--	-----------------	---	----------

### REAR SUSPENSION

#### SHOCK ABSORBER

Nitro Gas - Performance			<b>12718GR</b>	2	\$153.00
Foam Cell - Performance			<b>24718FE</b>	2	\$222.00

#### COIL SPRINGS

	Est. Lift	Additional Load			
Medium	40mm	0 - 250kg	<b>NISS042B</b>	1	\$250.00
Heavy	40mm	250kg - GVM	<b>NISS042C</b>	1	\$250.00

### SUSPENSION KIT

Medium - Nitro Gas	<b>NISS042BKG1</b>	\$1247.00
Medium - Foam Cell	<b>NISS042BKF1</b>	\$1441.00
Heavy - Nitro Gas	<b>NISS042CKG1</b>	\$1247.00
Heavy - Foam Cell	<b>NISS042CKF1</b>	\$1441.00

• Specify front Coil Springs when ordering

### SUSPENSION KIT CONTENTS

Shock Absorbers

Strut Shock Absorbers

Coil Springs



stay safe...

practice responsible social distancing!

for a full range of accessories visit our website

[www.ironman4x4.com](http://www.ironman4x4.com)







R51 (4cyl Diesel and V6 Petrol)  
7/2005+

# Nissan Pathfinder

Product Description

Part No.

Qty  
ReqRetail  
ea Inc GST

## SUSPENSION TO SUIT NISSAN PATHFINDER

### FRONT SUSPENSION

#### SHOCK ABSORBER

Nitro Gas Strut - Performance			<b>12716GR</b>	2	\$222.00
Foam Cell Strut - Performance			<b>24716FE</b>	2	\$250.00
Foam Cell Pro Strut - Performance			<b>45716FE</b>	2	\$388.00
Foam Cell Pro Strut - Performance - Long Travel* <b>(SEE NOTE)</b>			<b>45716LFE *</b>	2	\$388.00

\*NOTE: MANDATORY FITMENT of Ironman 4x4 UCA048FA is required with Long Travel - Foam Cell Pro

- Height adjustable with Ironman 4x4 Strut Trim Packers
- Foam Cell Pro contains a single adjusting ring for driveshaft clearance

#### COIL SPRINGS

	Est. Lift	Additional Load			
Medium	35mm	0 - 50kg	<b>NISS040B</b>	1	\$250.00
Heavy	35mm	50 - 110kg	<b>NISS040C</b>	1	\$250.00

#### STRUT MOUNTS

Steel Strut Top			<b>ISST007</b>	2	\$84.00
-----------------	--	--	----------------	---	---------

#### TRIM PACKERS

5mm Strut Trim Packer	Nitro Gas / Foam Cell	<b>HILFR05 / HILFR05F</b>	2	\$28.00
10mm Strut Trim Packer	Nitro Gas / Foam Cell	<b>HILFR10 / HILFR10F</b>	2	\$28.00
15mm Strut Trim Packer	Nitro Gas / Foam Cell	<b>HILFR15 / HILFR15F</b>	2	\$28.00

- ONLY Compatible with Ironman 4x4 Struts (Except Pro), lift height subject to 2:1 motion ratio. Unnecessary fitment may lift vehicle too high

#### CONTROL ARMS

Pro-Forge Upper Control Arms			<b>UCA048FA</b>	1	\$882.00
------------------------------	--	--	-----------------	---	----------

### REAR SUSPENSION

#### SHOCK ABSORBER

Nitro Gas - Performance			<b>12718GR</b>	2	\$153.00
Foam Cell - Performance			<b>24718FE</b>	2	\$222.00

#### COIL SPRINGS

	Est. Lift	Additional Load			
Medium	40mm	0 - 250kg	<b>NISS042B</b>	1	\$250.00
Heavy	40mm	250kg - GVM	<b>NISS042C</b>	1	\$250.00

### SUSPENSION KIT

Medium - Nitro Gas		<b>NISS042BKG</b>	\$1247.00
Medium - Foam Cell		<b>NISS042BKF</b>	\$1441.00
Heavy - Nitro Gas		<b>NISS042CKG</b>	\$1247.00
Heavy - Foam Cell		<b>NISS042CKF</b>	\$1441.00

- Specify front Coil Springs when ordering
- Mandatory 4 wheel alignment after installing new suspension

### SUSPENSION KIT CONTENTS

Shock Absorbers

Strut Shock Absorbers

Coil Springs



# Nissan Pathfinder

R50  
1995 to 7/2005



Product Description

Part No.

Qty  
Req

Retail  
ea Inc GST

## SUSPENSION TO SUIT NISSAN PATHFINDER

### FRONT SUSPENSION

**COIL SPRINGS**

	Est. Lift	Additional Load	Part No.	Qty	Retail Price
Medium	35mm	0 - 50kg	<b>NISS034B</b>	1	\$250.00

**CAMBER CORRECTION**

Camber Bolt Kit			<b>ICAMBER14</b>	1	\$28.00
-----------------	--	--	------------------	---	---------

### REAR SUSPENSION

**COIL SPRINGS**

	Est. Lift	Additional Load	Part No.	Qty	Retail Price
Medium	35mm	0 - 200kg	<b>NISS035B</b>	1	\$250.00





R20 / WD21  
Pre 1995

# SUSPENSION TO SUIT Nissan Pathfinder / Terrano / II

Product Description

Part No.

Qty  
Req

Retail  
ea Inc GST

## SUSPENSION TO SUIT NISSAN PATHFINDER / TERRANO / II

### FRONT SUSPENSION

#### SHOCK ABSORBER

Nitro Gas - Performance	<b>12667GR</b>	2	\$153.00
Foam Cell - Performance	<b>24667FE</b>	2	\$222.00

#### TORSION BAR

Uprated Torsion Bars	<b>NISS017</b>	1	\$416.00
----------------------	----------------	---	----------

• Minimum 60mm downward suspension travel required after adjustment

### REAR SUSPENSION

#### SHOCK ABSORBER

Nitro Gas - Comfort	<b>12636GRC</b>	2	\$153.00
Nitro Gas - Performance	<b>12636GR</b>	2	\$153.00
Nitro Gas - Professional	<b>12636GRP</b>	2	\$153.00
Foam Cell - Comfort	<b>24636FEC</b>	2	\$222.00
Foam Cell - Performance	<b>24636FE</b>	2	\$222.00
Foam Cell - Professional	<b>24636FEP</b>	2	\$222.00

#### COIL SPRINGS

	Est. Lift	Additional Load			
Medium	40mm	0 - 250kg	<b>NISS018B</b>	1	\$250.00
Heavy	40mm	250kg - GVM	<b>HOLD008B</b>	1	\$250.00

### SUSPENSION KIT

Medium - Nitro Gas	<b>NISS018BK</b>	\$1275.00
Medium - Foam Cell	<b>NISS018BK</b>	\$1552.00
Heavy - Nitro Gas	<b>NISS018CK</b>	\$1275.00
Heavy - Foam Cell	<b>NISS018CK</b>	\$1552.00

### SUSPENSION KIT CONTENTS

Shock Absorbers

Coil Springs

Torsion Bars

# Nissan Patrol

Y62  
2010 to 2019



Product Description

Part No.

Qty  
Req

Retail  
ea Inc GST

## ACCESSORIES TO SUIT NISSAN PATROL

**STEEL WINCH BULL BARS**

Premium Commercial Deluxe - 60.3mm Tube

• Does not suit vehicles with Adaptive Cruise Control.

**BBP062**

\$2414.00

**BREATHER KIT**

Universal Twin Manifold Filtered Breather Kit

**IDIFFBRE**

\$115.00

## Nissan Patrol

Y62  
2010+

## Product Description

## Part No.

Qty  
ReqRetail  
ea Inc GST

## SUSPENSION TO SUIT NISSAN PATROL

## FRONT SUSPENSION

## SHOCK ABSORBER

Nitro Gas Strut - Performance			<b>12740GR</b>	2	\$222.00
Foam Cell Strut - Performance			<b>24740FE</b>	2	\$250.00
Foam Cell Pro Strut - Performance			<b>45740FE</b>	2	\$388.00

- Height adjustable with Ironman 4x4 Strut Trim Packers
- Non HBMC models only

## COIL SPRINGS

	Est. Lift	Additional Load			
Light	30mm	0 - 50kg	<b>NISS045A</b>	1	\$250.00
Medium	40mm	0 - 50kg	<b>NISS045B</b>	1	\$250.00
Heavy	50mm	50 - 110kg	<b>NISS045C</b>	1	\$250.00

## TRIM PACKERS

5mm Strut Trim Packer	Nitro Gas / Foam Cell	<b>HILFR05 / HILFR05F</b>	2	\$28.00
10mm Strut Trim Packer	Nitro Gas / Foam Cell	<b>HILFR10 / HILFR10F</b>	2	\$28.00
15mm Strut Trim Packer	Nitro Gas / Foam Cell	<b>HILFR15 / HILFR15F</b>	2	\$28.00

- ONLY Compatible with Ironman 4x4 Struts (except Pro), lift height subject to 2:1 motion ratio. Unnecessary fitment may lift vehicle too high

## SWAY BAR

36mm Sway Bar	<b>ISB600F</b>	1	\$582.00
---------------	----------------	---	----------

## REAR SUSPENSION

## SHOCK ABSORBER

Nitro Gas - Performance		<b>12742GR</b>	2	\$153.00
Foam Cell - Performance		<b>24742FE</b>	2	\$222.00
Foam Cell Pro - Performance		<b>45742FE</b>	2	\$305.00

- Non HBMC models only

## COIL SPRINGS

	Est. Lift	Additional Load			
Light	30mm	0 - 300kg	<b>NISS046A</b>	1	\$291.00
Medium	40mm	0 - 300kg	<b>NISS046B</b>	1	\$291.00
Heavy	50mm	300kg - GVM	<b>NISS046C</b>	1	\$291.00

## SWAY BAR

27mm Sway Bar	<b>ISB600R</b>	1	\$582.00
---------------	----------------	---	----------

## SUSPENSION KIT

Light - Nitro Gas	<b>NISS045AKG</b>	\$1289.00
Light - Foam Cell	<b>NISS045AKF</b>	\$1483.00
Light - Foam Cell Pro	<b>NISS045AKP</b>	\$1926.00
Medium - Nitro Gas	<b>NISS045BKG</b>	\$1289.00
Medium - Foam Cell	<b>NISS045BKF</b>	\$1483.00
Medium - Foam Cell Pro	<b>NISS045BKP</b>	\$1926.00
Heavy - Nitro Gas	<b>NISS045CKG</b>	\$1289.00
Heavy - Foam Cell	<b>NISS045CKF</b>	\$1483.00
Heavy - Foam Cell Pro	<b>NISS045CKP</b>	\$1926.00

- Non HBMC models only

- Mandatory 4 wheel alignment after installing new suspension

- Specify front Coil Springs when ordering

## SUSPENSION KIT CONTENTS

Shock Absorbers	Leaf Springs
Strut Shock Absorbers	Coil Springs



Product Description

Part No.

Qty  
ReqRetail  
ea Inc GST

## ACCESSORIES TO SUIT NISSAN PATROL

**STEEL WINCH BULL BARS**

Premium - 60.3mm Tube

BBP011

\$2371.00

**STEEL SIDE STEPS AND RAILS**

Side Steps

SS012

\$962.00

Side Steps and Rails

SSR012

\$1155.00

Premium Side Steps and Rails - 60.3mm Tube

SSRP011

\$1276.00

**RECOVERY POINTS - IRONMAN 4X4 BULL BAR ONLY**

Recovery Points - 5000kg Rating (Pair)

IRP005

\$217.00

**LOCKSAFE DRAWER SYSTEMS**

Twin Drawers - 1000mm

ITD1000

\$1296.00

Single Drawer - 1000mm

ISD1000

\$784.00

Wing Kit - 1000mm (DX, ST, STI)

ITDW011

\$270.00

Wing Kit - 1000mm (STL, Di)

ITDW012

\$270.00

**SNORKEL**

GU Patrol Series 4

ISNORKEL013

\$418.00

**EXHAUST SYSTEM**BigBore GU Patrol 3L Turbo Diesel Wagon (CRD and Di) - *While Stocks Last*

IEXHAUST006

\$1301.00

**STEEL ROOF RACKS**

Cage Style - 1.4m x 1.25m

IRRCAGE14

\$777.00

Cage Style - 1.8m x 1.25m

IRRCAGE18

\$815.00

Cage Style - 2.2m x 1.25m

IRRCAGE22

\$846.00

Rooftop Tent Compatible - 1.8m x 1.25m

IRRTENT18

\$777.00

Rooftop Tent Compatible - 2.2m x 1.25m

IRRTENT22

\$815.00

Trade Style - 1.8m x 1.25m (Open end)

IRRTRADE18

\$777.00

Trade Style - 2.2m x 1.25m (Open end)

IRRTRADE22

\$809.00

**ALLOY ROOF RACKS**

Cage Style - 1.4m x 1.25m

IRRCAGE14-ALLOY

\$983.00

Cage Style - 1.8m x 1.25m

IRRCAGE18-ALLOY

\$1149.00

Cage Style - 2.2m x 1.25m

IRRCAGE22-ALLOY

\$1212.00

Trade Style - 1.4m x 1.25m (Open end)

IRROPEN14-ALLOY

\$971.00

Trade Style - 1.8m x 1.25m (Open end)

IRRTRADE18-ALLOY

\$1132.00

Trade Style - 2.2m x 1.25m (Open end)

IRRTRADE22-ALLOY

\$1181.00

Flat Rack - 1.8m x 1.25m

IRRTFLAT18-ALLOY

\$1116.00

**ROOF RACK - MOUNTING KITS**

Gutter Mount Feet - 100mm (8 Feet)

IRRFEET100

\$198.00

Gutter Mount Feet - 125mm (8 Feet)

IRRFEET125

\$198.00

**UNDERBODY PROTECTION**Radiator and Transmission - *While Stocks Last*

IUP015K

\$563.00

• 3.0L and 4.8L only.

**SEAT COVER**

Canvas Comfort - Front

ICSC011F

\$401.00

Canvas Comfort - Rear

ICSC011R

\$401.00

Canvas Comfort - Front Bucket + 3/4 Bench (GU4-GU8 Single Cab DX only)

ICSC011F3/4

\$401.00

**DIFF BREATHER KIT**

Diff Breather Kit

IDIFFBRE

\$115.00



## Nissan Patrol

Y61 GU Series 1-3  
1998 to 2004

Product Description

Part No.

Qty  
ReqRetail  
ea Inc GST

## ACCESSORIES TO SUIT NISSAN PATROL

**STEEL WINCH BULL BARS**

Commercial Deluxe (Coil Spring Only)

BBCD009

\$2244.00

**STEEL SIDE STEPS AND RAILS**

Side Steps

SS012

\$962.00

Side Steps and Rails

SSR012

\$1155.00

**RECOVERY POINTS - IRONMAN 4X4 BULL BAR ONLY**

Recovery Points - 5000kg Rating (Pair)

IRP005

\$217.00

• Series 3-5 only.

**LOCKSAFE DRAWER SYSTEMS**

Twin Drawers - 1000mm

ITD1000

\$1296.00

Single Drawer - 1000mm

ISD1000

\$784.00

Wing Kit - 1000mm (DX, ST, STI)\*

ITDW011

\$270.00

Wing Kit - 1000mm (STL, Di)

ITDW012

\$270.00

**SNORKEL**

GU Patrol Series 1 2 and 3

ISNORKEL015

\$418.00

**EXHAUST SYSTEM**BigBore GU Patrol 3L Turbo Diesel Wagon - *While Stocks Last*

IEXHAUST006

\$1301.00

**STEEL ROOF RACKS**

Cage Style - 1.4m x 1.25m

IRRCAGE14

\$777.00

Cage Style - 1.8m x 1.25m

IRRCAGE18

\$815.00

Cage Style - 2.2m x 1.25m

IRRCAGE22

\$846.00

Rooftop Tent Compatible - 1.8m x 1.25m

IRR TENT18

\$777.00

Rooftop Tent Compatible - 2.2m x 1.25m

IRR TENT22

\$815.00

Trade Style - 1.8m x 1.25m (Open end)

IRR TRADE18

\$777.00

Trade Style - 2.2m x 1.25m (Open end)

IRR TRADE22

\$809.00

**ALLOY ROOF RACKS**

Cage Style - 1.4m x 1.25m

IRRCAGE14-ALLOY

\$983.00

Cage Style - 1.8m x 1.25m

IRRCAGE18-ALLOY

\$1149.00

Cage Style - 2.2m x 1.25m

IRRCAGE22-ALLOY

\$1212.00

Trade Style - 1.4m x 1.25m (Open end)

IRROPEN14-ALLOY

\$971.00

Trade Style - 1.8m x 1.25m (Open end)

IRR TRADE18-ALLOY

\$1132.00

Trade Style - 2.2m x 1.25m (Open end)

IRR TRADE22-ALLOY

\$1181.00

Flat Rack - 1.8m x 1.25m

IRR FLAT18-ALLOY

\$1116.00

**ROOF RACK - MOUNTING KITS**

Gutter Mount Feet - 100mm (8 Feet)

IRRF EET100

\$198.00

Gutter Mount Feet - 125mm (8 Feet)

IRRF EET125

\$198.00

**UNDERBODY PROTECTION**Radiator and Transmission - *While Stocks Last*

IUP015K

\$563.00

• 3.0L and 4.8L only.

**DIFF BREATHER KIT**

Diff Breather Kit

IDIFFBRE

\$115.00

LISTING  
CONTINUED  
OVER THE  
PAGE



Product Description

Part No.

Qty  
Req

Retail  
ea Inc GST

## SUSPENSION TO SUIT NISSAN PATROL

### FRONT SUSPENSION

#### SHOCK ABSORBER

Nitro Gas - Performance			<b>12091GR</b>	2	\$153.00
Foam Cell - Performance			<b>24091FE</b>	2	\$222.00
Foam Cell - Professional			<b>24091FEP</b>	2	\$222.00
Foam Cell - Performance	Suits 4" Lift		<b>24091LFE</b>	2	\$250.00
Foam Cell - Performance	Suits 6" Lift		<b>24091LFE1</b>	2	\$278.00
Foam Cell Pro - Performance			<b>45091FE</b>	2	\$305.00
Foam Cell Pro - Professional			<b>45091FEP</b>	2	\$305.00
Foam Cell Pro - Performance	Suits 4" Lift		<b>45091LFE</b>	2	\$319.00
Foam Cell Pro - Professional	Suits 4" Lift		<b>45091LFE1</b>	2	\$319.00
Foam Cell Pro - Performance	Suits 6" Lift		<b>45091LFE1</b>	2	\$333.00

#### COIL SPRINGS

	Est. Lift	Additional Load			
Medium	50mm	0 - 50kg	<b>NISS024B</b>	1	\$250.00
Medium - 4" Lift	100mm	0 - 100kg	<b>NISS026B</b>	1	\$388.00
Medium - 6" Lift	150mm	0 - 100kg	<b>NISS043B</b>	1	\$458.00
Heavy	50mm	50 - 110kg	<b>NISS009C</b>	1	\$250.00

#### STEERING DAMPER

Foam Cell	Pre 2/2000		<b>3511</b>	1	\$167.00
Foam Cell	2/2000+		<b>3501</b>	1	\$167.00

#### CASTER CORRECTION

2° Offset Bush Kit - Polyurethane			<b>1144SK</b>	1	\$153.00
2° Offset Bush Kit - Rubber			<b>1144RK</b>	1	\$153.00
5° Offset Plate Kit			<b>CPLATE003</b>	1	\$222.00
Radius Arm Spacer	15mm		<b>833WT</b>	1	\$84.00
4° Drop Box			<b>DBOX003</b>	1	\$388.00

#### STEERING RODS

Adjustable Drag Link			<b>ADL005</b>	1	\$485.00
Track Rod			<b>ATR005</b>	1	\$485.00

#### ADJUSTABLE PANHARD ROD

Right Hand Drive Rod	Pre 2/2000		<b>PANHARD003</b>	1	\$319.00
Left Hand Drive Rod	Pre 2/2000		<b>PANHARD008</b>	1	\$319.00
Right Hand Drive Rod	2/2000+		<b>PANHARD005</b>	1	\$333.00
Left Hand Drive Rod	2/2000+		<b>PANHARD009</b>	1	\$333.00

#### SWAY BAR LINK

Extended Sway Bar Link	Suits 1-3" Lift		<b>SBEXT006</b>	2	\$84.00
Extended Sway Bar Link	Suits 4-7" Lift		<b>SBEXT003</b>	2	\$84.00

#### COIL SPACER

Polyurethane 15mm	Provides 10mm Lift		<b>PATF15</b>	2	\$28.00
Polyurethane 30mm	Provides 25mm Lift		<b>PATF30</b>	2	\$42.00

#### BRAKE HOSE

Extended Brake Hose	Non ABS Models		<b>BHOSE003</b>	1	\$70.00
Extended Brake Hose	ABS models		<b>BHOSE005</b>	2	\$70.00

## Nissan Patrol



Y61 GU LWB Wagon

Product Description	Part No.	Qty Req	Retail ea Inc GST
<b>REAR SUSPENSION</b>			
<b>SHOCK ABSORBER</b>			
Nitro Gas - Performance	12094GR	2	\$153.00
Foam Cell - Performance	24094FE	2	\$222.00
Foam Cell - Professional	24094FEP	2	\$222.00
Foam Cell - Performance	24094LFE	2	\$250.00
Foam Cell - Professional	24094LFEP	2	\$250.00
Foam Cell - Performance	24094LFE1	2	\$278.00
Foam Cell Pro - Performance	45094FE	2	\$305.00
Foam Cell Pro - Professional	45094FEP	2	\$305.00
Foam Cell Pro - Performance	45094LFE	2	\$319.00
Foam Cell Pro - Professional	45094LFEP	2	\$319.00
Foam Cell Pro - Performance	45094LFE1	2	\$333.00
<b>COIL SPRINGS</b>			
	Est. Lift	Additional Load	
Medium	50mm	0 - 200kg	NISS010C 1 \$264.00
Medium - 4" Lift	100mm	0 - 300kg	NISS027B 1 \$388.00
Medium - 6" Lift	150mm	0 - 300kg	NISS044B 1 \$458.00
Heavy	50mm	200 - 400kg	NISS020C 1 \$278.00
Heavy - 4" Lift	100mm	400kg - GVM	NISS027C 1 \$388.00
Heavy - 6" Lift	150mm	400kg - GVM	NISS044C 1 \$458.00
Extra Heavy	50mm	400kg - GVM	NISS020D 1 \$416.00
<b>PANHARD ROD</b>			
Adjustable Panhard Rod	Pre 2/2000	PANHARD004	1 \$319.00
Adjustable Panhard Rod	2/2000+	PANHARD006	1 \$333.00
<b>ADJUSTABLE TRAILING ARM</b>			
Upper Trailing Arm		UTA003	2 \$208.00
Lower Trailing Arm		LTA003	2 \$264.00
<b>SWAY BAR LINK</b>			
Extended Sway Bar Link	Suits 1-3" Lift	Right Side	SBEXT006 1 \$84.00
Extended Sway Bar Link	Suits 4-7" Lift	Right Side	SBEXT003 1 \$84.00
Extended Sway Bar Link	Suits 1-3" Lift	Left Side	SBEXT007 1 \$84.00
Extended Sway Bar Link	Suits 4-7" Lift	Left Side	SBEXT004 1 \$84.00
<b>COIL SPACER</b>			
Polyurethane 15mm	Provides 10mm Lift	PATR15	2 \$28.00
Polyurethane 30mm	Provides 25mm Lift	PATR30	2 \$42.00
<b>BRAKE HOSE</b>			
Extended Brake Hose		BHOSE004	1 \$70.00
<b>BRACKET KIT</b>			
Coil Drop Out Cone		IDOC003	1 \$250.00
Coil Retainer Kit		ICR003	1 \$125.00
<b>BUSH KIT</b>			
Rubber Suspension Arm Bush Kit - Pre 2/2000	W/ Standard Radius Arm Bushes	839RK	1 \$402.00
Rubber Suspension Arm Bush Kit - Pre 2/2000	W/ Offset Radius Arm Bushes	839CRK	1 \$402.00
Rubber Suspension Arm Bush Kit - 2/2000+	W/ Standard Radius Arm Bushes	848RK	1 \$430.00
Rubber Suspension Arm Bush Kit - 2/2000+	W/ Offset Radius Arm Bushes	848CRK	1 \$430.00

LISTING  
CONTINUED  
OVER THE  
PAGE

# Nissan Patrol

Y61 GU LWB Wagon



Product Description

Part No.

Qty  
Req

Retail  
ea Inc GST

**SUSPENSION KIT**

Medium - Nitro Gas			<b>NISS024CKG</b>	\$1123.00
Medium - Foam Cell			<b>NISS024CKF</b>	\$1400.00
Medium - Foam Cell	4"Lift	RHD - Pre 2/2000	<b>NISS026BKF</b>	\$4045.00
Medium - Foam Cell	4"Lift	LHD - Pre 2/2000	<b>NISS026BKFL</b>	\$4045.00
Medium - Foam Cell	6"Lift	RHD - Pre 2/2000	<b>NISS043BKF</b>	\$4295.00
Medium - Foam Cell	6"Lift	LHD - Pre 2/2000	<b>NISS043BKFL</b>	\$4295.00
Medium - Foam Cell	4"Lift	RHD - 2/2000+	<b>NISS026BKF1</b>	\$4073.00
Medium - Foam Cell	4"Lift	LHD - 2/2000+	<b>NISS026BKF1L</b>	\$4073.00
Medium - Foam Cell	6"Lift	RHD - 2/2000+	<b>NISS043BKF1</b>	\$4322.00
Medium - Foam Cell	6"Lift	LHD - 2/2000+	<b>NISS043BKF1L</b>	\$4322.00
Medium - Foam Cell Pro			<b>NISS024CKP</b>	\$1732.00
Medium - Foam Cell Pro	4"Lift	RHD - Pre 2/2000	<b>NISS026BKP</b>	\$4322.00
Medium - Foam Cell Pro	4"Lift	LHD - Pre 2/2000	<b>NISS026BKPL</b>	\$4322.00
Medium - Foam Cell Pro	6"Lift	RHD - Pre 2/2000	<b>NISS043BKP</b>	\$4516.00
Medium - Foam Cell Pro	6"Lift	LHD - Pre 2/2000	<b>NISS043BKPL</b>	\$4516.00
Medium - Foam Cell Pro	4"Lift	RHD - 2/2000+	<b>NISS026BKP1</b>	\$4350.00
Medium - Foam Cell Pro	4"Lift	LHD - 2/2000+	<b>NISS026BKP1L</b>	\$4350.00
Medium - Foam Cell Pro	6"Lift	RHD - 2/2000+	<b>NISS043BKP1</b>	\$4544.00
Medium - Foam Cell Pro	6"Lift	LHD - 2/2000+	<b>NISS043BKP1L</b>	\$4544.00
Heavy - Nitro Gas			<b>NISS037CKG</b>	\$1136.00
Heavy - Foam Cell			<b>NISS037CKF</b>	\$1413.00
Heavy - Foam Cell	4"Lift	RHD - Pre 2/2000	<b>NISS026CKF</b>	\$4045.00
Heavy - Foam Cell	6"Lift	RHD - Pre 2/2000	<b>NISS043CKF</b>	\$4295.00
Heavy - Foam Cell	4"Lift	RHD - 2/2000+	<b>NISS026CKF1</b>	\$4073.00
Heavy- Foam Cell	6"Lift	RHD - 2/2000+	<b>NISS043CKF1</b>	\$4322.00
Heavy - Foam Cell Pro			<b>NISS037CKP</b>	\$1746.00
Heavy - Foam Cell Pro	4"Lift	RHD - Pre 2/2000	<b>NISS026CKP</b>	\$4322.00
Heavy- Foam Cell Pro	6"Lift	RHD - Pre 2/2000	<b>NISS043CKP</b>	\$4516.00
Heavy - Foam Cell Pro	4"Lift	RHD - 2/2000+	<b>NISS026CKP1</b>	\$4350.00
Heavy- Foam Cell Pro	6"Lift	RHD - 2/2000+	<b>NISS043CKP1</b>	\$4544.00
Extra Heavy - Nitro Gas			<b>NISS037DKG</b>	\$1275.00
Extra Heavy - Foam Cell			<b>NISS037DKF</b>	\$1464.00
Extra Heavy - Foam Cell Pro			<b>NISS037DKP</b>	\$1884.00

• Specify ABS / non-ABS brake hoses when ordering suspension kits

• 4" and 6" lifts may not be legal for on-road use in your area, certification may be required for on-road use

• Due to the extreme nature of 4" and 6" lifts, further modifications may be required, and will vary between vehicles, such modifications are entirely the owners responsibility

Ironman 4x4 accept no responsibility for any damage or injury caused by use of the these products

**50MM SUSPENSION KIT CONTENTS**

Shock Absorbers

Coil Springs

**4" AND 6" SUSPENSION KIT CONTENTS**

Shock Absorbers

Coil Springs

Panhard Rods

Sway Bar Links

Caster Plates

Brake Hoses

Adjustable Trailing Arms







No matter where you are, or where you go!

for a full range of accessories visit our website

[www.ironman4x4.com](http://www.ironman4x4.com)







Product Description

Part No.

Qty  
Req

Retail  
ea Inc GST

## SUSPENSION TO SUIT NISSAN PATROL

### FRONT SUSPENSION

#### SHOCK ABSORBER

Nitro Gas - Performance			<b>12091GR</b>	2	\$153.00
Foam Cell - Performance			<b>24091FE</b>	2	\$222.00
Foam Cell - Professional			<b>24091FEP</b>	2	\$222.00
Foam Cell - Performance		Suits 4" Lift	<b>24091LFE</b>	2	\$250.00
Foam Cell - Performance		Suits 6" Lift	<b>24091LFE1</b>	2	\$278.00
Foam Cell Pro - Performance			<b>45091FE</b>	2	\$305.00
Foam Cell Pro - Professional			<b>45091FEP</b>	2	\$305.00
Foam Cell Pro - Performance		Suits 4" Lift	<b>45091LFE</b>	2	\$319.00
Foam Cell Pro - Professional		Suits 4" Lift	<b>45091LFEP</b>	2	\$319.00
Foam Cell Pro - Performance		Suits 6" Lift	<b>45091LFE1</b>	2	\$333.00

#### COIL SPRINGS

	Est. Lift	Additional Load			
Medium	50mm	0 - 50kg	<b>NISS024B</b>	1	\$250.00
Heavy	50mm	50 - 110kg	<b>NISS009C</b>	1	\$250.00
Medium - 4" Lift	100mm	0 - 100kg	<b>NISS026B</b>	1	\$388.00
Medium - 6" Lift	150mm	0 - 100kg	<b>NISS043B</b>	1	\$458.00

#### STEERING DAMPER

Foam Cell			<b>3511</b>	1	\$167.00
-----------	--	--	-------------	---	----------

#### CASTER CORRECTION

2° Offset Bush Kit - Polyurethane			<b>1144SK</b>	1	\$153.00
2° Offset Bush Kit - Rubber			<b>1144RK</b>	1	\$153.00
5° Offset Plate Kit			<b>CPLATE003</b>	1	\$222.00
Radius Arm Spacer		15mm	<b>833WT</b>	1	\$84.00
4° Drop Box			<b>DBOX003</b>	1	\$388.00

#### STEERING RODS

Adjustable Drag Link			<b>ADL003</b>	1	\$485.00
Track Rod			<b>ATRO03</b>	1	\$485.00

#### ADJUSTABLE PANHARD ROD

Right Hand Drive Rod			<b>PANHARD003</b>	1	\$319.00
Left Hand Drive Rod			<b>PANHARD008</b>	1	\$319.00

#### SWAY BAR LINK

Extended Sway Bar Link		Suits 1-3" Lift	<b>SBEXT006</b>	2	\$84.00
Extended Sway Bar Link		Suits 4-7" Lift	<b>SBEXT003</b>	2	\$84.00

#### COIL SPACER

Polyurethane 15mm		Provides 10mm Lift	<b>PATF15</b>	2	\$28.00
Polyurethane 30mm		Provides 25mm Lift	<b>PATF30</b>	2	\$42.00

#### BRAKE HOSE

Extended Brake Hose		Non ABS Models	<b>BHOSE003</b>	1	\$70.00
Extended Brake Hose		ABS models	<b>BHOSE005</b>	2	\$70.00



Y60 GQ / Y61 GU  
Cab Chassis (Coil/Coil)

SUSPENSION TO SUIT

# Nissan Patrol

Product Description

Part No.

Qty  
Req

Retail  
ea Inc GST

## REAR SUSPENSION

### SHOCK ABSORBER

Nitro Gas - Performance			<b>12094GR</b>	2	\$153.00
Foam Cell - Performance			<b>24094FE</b>	2	\$222.00
Foam Cell - Professional			<b>24094FEP</b>	2	\$222.00
Foam Cell - Performance	Suits 4" Lift		<b>24094LFE</b>	2	\$250.00
Foam Cell - Professional	Suits 4" Lift		<b>24094LFEP</b>	2	\$250.00
Foam Cell - Performance	Suits 6" Lift		<b>24094LFE1</b>	2	\$278.00
Foam Cell Pro - Performance			<b>45094FE</b>	2	\$305.00
Foam Cell Pro - Professional			<b>45094FEP</b>	2	\$305.00
Foam Cell Pro - Performance	Suits 4" Lift		<b>45094LFE</b>	2	\$319.00
Foam Cell Pro - Professional	Suits 4" Lift		<b>45094LFEP</b>	2	\$319.00
Foam Cell Pro - Performance	Suits 6" Lift		<b>45094LFE1</b>	2	\$333.00

### COIL SPRINGS

	Est. Lift	Additional Load			
Medium	50mm	0 - 300kg	<b>NISS020B</b>	1	\$264.00
Medium - 4" Lift	100mm	0 - 300kg	<b>NISS027B</b>	1	\$388.00
Medium - 6" Lift	150mm	0 - 300kg	<b>NISS044B</b>	1	\$458.00
Heavy	50mm	300 - 400kg	<b>NISS020C</b>	1	\$278.00
Heavy - 4" Lift	100mm	400kg - GVM	<b>NISS027C</b>	1	\$388.00
Heavy - 6" Lift	150mm	400kg - GVM	<b>NISS044C</b>	1	\$458.00
Extra Heavy	50mm	400kg - GVM	<b>NISS020D</b>	1	\$416.00

### PANHARD ROD

Adjustable Panhard Rod			<b>PANHARD004</b>	1	\$319.00
------------------------	--	--	-------------------	---	----------

### ADJUSTABLE TRAILING ARM

Upper Trailing Arm			<b>UTA003</b>	2	\$208.00
Lower Trailing Arm			<b>LTA003</b>	2	\$264.00

### SWAY BAR LINK

Extended Sway Bar Link	Suits 1-3" Lift	Right Side	<b>SBEXT006</b>	1	\$84.00
Extended Sway Bar Link	Suits 4-7" Lift	Right Side	<b>SBEXT003</b>	1	\$84.00
Extended Sway Bar Link	Suits 1-3" Lift	Left Side	<b>SBEXT007</b>	1	\$84.00
Extended Sway Bar Link	Suits 4-7" Lift	Left Side	<b>SBEXT004</b>	1	\$84.00

### COIL SPACER

Polyurethane 15mm	Provides 10mm Lift		<b>PATR15</b>	2	\$28.00
Polyurethane 30mm	Provides 25mm Lift		<b>PATR30</b>	2	\$42.00

### BRAKE HOSE

Extended Brake Hose			<b>BHOSE004</b>	1	\$70.00
---------------------	--	--	-----------------	---	---------

### BRACKET KIT

Coil Drop Out Cone			<b>IDOC003</b>	1	\$250.00
Coil Retainer Kit			<b>ICR003</b>	1	\$125.00

### BUSH KIT

Rubber Suspension Arm Bush Kit	W/ Standard Radius Arm Bushes		<b>839RK</b>	1	\$402.00
Rubber Suspension Arm Bush Kit	W/ Offset Radius Arm Bushes		<b>839CRK</b>	1	\$402.00

LISTING  
CONTINUED  
OVER THE  
PAGE

# Nissan Patrol

Y60 GQ / Y61 GU  
Cab Chassis (Coil/Coil)



**Product Description**

**Part No.**

**Qty  
Req**

**Retail  
ea Inc GST**

**SUSPENSION KIT**

Medium - Nitro Gas			<b>NISS037BKG</b>	\$1123.00
Medium - Foam Cell			<b>NISS037BKF</b>	\$1400.00
Medium - Foam Cell	4"Lift	RHD	<b>NISS026BKF</b>	\$4045.00
Medium - Foam Cell	4"Lift	LHD	<b>NISS026BKFL</b>	\$4045.00
Medium - Foam Cell	6"Lift	RHD	<b>NISS043BKF</b>	\$4295.00
Medium - Foam Cell	6"Lift	LHD	<b>NISS043BKFL</b>	\$4295.00
Medium - Foam Cell Pro			<b>NISS037BKP</b>	\$1732.00
Medium - Foam Cell Pro	4"Lift	RHD	<b>NISS026BKP</b>	\$4322.00
Medium - Foam Cell Pro	4"Lift	LHD	<b>NISS026BKPL</b>	\$4322.00
Medium - Foam Cell Pro	6"Lift	RHD	<b>NISS043BKP</b>	\$4516.00
Medium - Foam Cell Pro	6"Lift	LHD	<b>NISS043BKPL</b>	\$4516.00
Heavy - Nitro Gas			<b>NISS037CKG</b>	\$1136.00
Heavy - Foam Cell			<b>NISS037CKF</b>	\$1413.00
Heavy - Foam Cell	4"Lift	RHD	<b>NISS026CKF</b>	\$4045.00
Heavy - Foam Cell	4"Lift	LHD	<b>NISS026CKFL</b>	\$4045.00
Heavy - Foam Cell	6"Lift	RHD	<b>NISS043CKF</b>	\$4295.00
Heavy - Foam Cell	6"Lift	LHD	<b>NISS043CKFL</b>	\$4295.00
Heavy - Foam Cell Pro			<b>NISS037CKP</b>	\$1746.00
Heavy - Foam Cell Pro	4"Lift	RHD	<b>NISS026CKP</b>	\$4322.00
Heavy - Foam Cell Pro	4"Lift	LHD	<b>NISS026CKPL</b>	\$4322.00
Heavy - Foam Cell Pro	6"Lift	RHD	<b>NISS043CKP</b>	\$4516.00
Heavy - Foam Cell Pro	6"Lift	LHD	<b>NISS043CKPL</b>	\$4516.00
Extra Heavy - Nitro Gas			<b>NISS037DKG</b>	\$1275.00
Extra Heavy - Foam Cell			<b>NISS037DKF</b>	\$1464.00
Extra Heavy - Foam Cell Pro			<b>NISS037DKP</b>	\$1884.00

• Specify ABS / non-ABS brake hoses when ordering suspension kits

• 4" and 6" lifts may not be legal for on-road use in your area, certification may be required for on-road use

• Due to the extreme nature of 4" and 6" lifts, further modifications may be required, and will vary between vehicles

Such modifications are entirely the owners responsibility. Ironman 4x4 accept no responsibility for any damage or injury caused by use of the these products

**50MM SUSPENSION KIT CONTENTS**

Shock Absorbers                      Coil Springs

**4" AND 6" SUSPENSION KIT CONTENTS**

Shock Absorbers                      Caster Plates  
Coil Springs                              Brake Hoses  
Panhard Rods                            Adjustable Trailing Arms  
Sway Bar Links

## Nissan Patrol



Y60 GQ / Y61 GU  
Cab Chassis (Coil/Leaf)

Product Description	Part No.	Qty Req	Retail ea Inc GST
<b>SUSPENSION TO SUIT NISSAN PATROL</b>			
<b>FRONT SUSPENSION</b>			
<b>SHOCK ABSORBER</b>			
Nitro Gas - Performance	12091GR	2	\$153.00
Foam Cell - Performance	24091FE	2	\$222.00
Foam Cell Pro - Performance	45091FE	2	\$305.00
Foam Cell Pro - Professional	45091FEP	2	\$305.00
<b>COIL SPRINGS</b>			
	Est. Lift	Additional Load	
Medium	50mm	0 - 50kg	NISS024B 1 \$250.00
Heavy	50mm	50 - 110kg	NISS009C 1 \$250.00
<b>STEERING DAMPER</b>			
Foam Cell	3511	1	\$167.00
<b>CASTER CORRECTION</b>			
2° Offset Bush Kit - Polyurethane	1144SK	1	\$153.00
2° Offset Bush Kit - Rubber	1144RK	1	\$153.00
5° Offset Plate Kit	CPLATE003	1	\$222.00
Radius Arm Spacer	833WT	1	\$84.00
4° Drop Box	DBOX003	1	\$388.00
<b>CROSSMEMBER SPACER</b>			
6mm / 12mm Spacer Kit	1002K	1	\$97.00
<b>STEERING RODS</b>			
Adjustable Drag Link	ADL003	1	\$485.00
Track Rod	ATRO03	1	\$485.00
<b>ADJUSTABLE PANHARD ROD</b>			
Right Hand Drive Rod	PANHARD003	1	\$319.00
Left Hand Drive Rod	PANHARD008	1	\$319.00
<b>SWAY BAR LINK</b>			
Extended Sway Bar Link	Suits 1-3" Lift	SBEXT006 2	\$84.00
<b>COIL SPACER</b>			
Polyurethane 15mm	Provides 10mm Lift	PATF15 2	\$28.00
Polyurethane 30mm	Provides 25mm Lift	PATF30 2	\$42.00
<b>BRAKE HOSE</b>			
Extended Brake Hose	BHOSE003	1	\$70.00
<b>REAR SUSPENSION</b>			
<b>SHOCK ABSORBER</b>			
Nitro Gas - Performance	12648GR	2	\$153.00
Foam Cell - Performance	24648FE	2	\$222.00
Foam Cell Pro - Performance	45648FE	2	\$305.00
<b>LEAF SPRINGS</b>			
	Est. Lift	Additional Load	
Heavy - Drivers Side	50mm	0 - 400kg	NISS012CD/S 1 \$527.00
Heavy - Near Side	50mm	0 - 400kg	NISS012CN/S 1 \$527.00
Extra Heavy - Drivers Side	50mm	400kg - GVM	NISS012DD/S 1 \$610.00
Extra Heavy - Near Side	50mm	400kg - GVM	NISS012DN/S 1 \$610.00
<b>U-BOLTS</b>			
U-Bolt Kit	Suits NISS012D	1100UBK 2	\$42.00
U-Bolt Kit	Suits NISS012D	1100UBKL 2	\$42.00
<b>POLYURETHANE SPRING BUSHES</b>			
Bush Kit	719UK	1	\$70.00
<b>GREASABLE SHACKLES AND PINS</b>			
Greasable Shackle	Left Hand Side	353LH 1	\$70.00
Greasable Shackle	Right Hand Side	353RH 1	\$70.00
Greasable Pin		667 2	\$42.00
<b>HELPER SPRINGS</b>			
Load Plus Helper Springs	LP4	1	\$157.00
<b>SUSPENSION KIT</b>			
Heavy - Nitro Gas	NISS036CKG		\$2064.00
Heavy - Foam Cell	NISS036CKF		\$2342.00
Heavy - Foam Cell Pro	NISS036CKP		\$2674.00
Extra Heavy - Nitro Gas	NISS036DKG		\$2148.00
Extra Heavy - Foam Cell	NISS036DKF		\$2425.00
Extra Heavy - Foam Cell Pro	NISS036DKP		\$2840.00
<b>SUSPENSION KIT CONTENTS</b>			
Shock Absorbers	Leaf Springs	Polyurethane Spring Bushes	
Coil Springs	U-Bolts		

# Nissan Patrol

Y60 GQ Station Wagon and Coil Cab  
1987 to 1997



Product Description

Part No.

Qty  
Req

Retail  
ea Inc GST

## ACCESSORIES TO SUIT NISSAN PATROL

### STEEL WINCH BULL BARS

Commercial Deluxe

BBCD010

\$2244.00

### LOCKSAFE DRAWER SYSTEMS

Twin Drawers - 1000mm

ITD1000

\$1296.00

Single Drawer - 1000mm

ISD1000

\$784.00

### SNORKEL

All Models Except 2.8L Diesel

ISNORKELO11

\$418.00

### STEEL ROOF RACKS

Cage Style - 1.4m x 1.25m

IRRCAGE14

\$777.00

Cage Style - 1.8m x 1.25m

IRRCAGE18

\$815.00

Cage Style - 2.2m x 1.25m

IRRCAGE22

\$846.00

Rooftop Tent Compatible - 1.8m x 1.25m

IRRTENT18

\$777.00

Rooftop Tent Compatible - 2.2m x 1.25m

IRRTENT22

\$815.00

Trade Style - 1.8m x 1.25m (Open end)

IRRTRADE18

\$777.00

Trade Style - 2.2m x 1.25m (Open end)

IRRTRADE22

\$809.00

### ALLOY ROOF RACKS

Cage Style - 1.4m x 1.25m

IRRCAGE14-ALLOY

\$983.00

Cage Style - 1.8m x 1.25m

IRRCAGE18-ALLOY

\$1149.00

Cage Style - 2.2m x 1.25m

IRRCAGE22-ALLOY

\$1212.00

Trade Style - 1.4m x 1.25m (Open end)

IRROPEN14-ALLOY

\$971.00

Trade Style - 1.8m x 1.25m (Open end)

IRRTRADE18-ALLOY

\$1132.00

Trade Style - 2.2m x 1.25m (Open end)

IRRTRADE22-ALLOY

\$1181.00

Flat Rack - 1.8m x 1.25m

IRRFLAT18-ALLOY

\$1116.00

### ROOF RACK - MOUNTING KITS

Gutter Mount Feet - 125mm (8 Feet - Does not fit high roof model)

IRRFEET125

\$198.00

Gutter Mount Feet - 210mm (8 Feet - Fits high roof model)

IRRFEET210

\$218.00

### DIFF BREATHER KIT

Diff Breather Kit

IDIFFBRE

\$115.00





## Nissan Patrol

Y60 GQ Cab Chassis (Leaf/Leaf)  
1988+

Product Description

Part No.

Qty  
ReqRetail  
ea Inc GST

## SUSPENSION TO SUIT NISSAN PATROL

## FRONT SUSPENSION

## SHOCK ABSORBER

Nitro Gas - Performance			<b>12661GR</b>	2	\$153.00
Foam Cell - Performance			<b>24661FE</b>	2	\$222.00
Foam Cell Pro - Performance			<b>45661FE</b>	2	\$305.00

## LEAF SPRINGS

	Est. Lift	Additional Load			
Heavy - Drivers Side	50mm	0 - 110kg	<b>NISS011CD/S</b>	1	\$402.00
Heavy - Near Side	50mm	0 - 110kg	<b>NISS011CN/S</b>	1	\$402.00

## STEERING DAMPER

Foam Cell			<b>3522</b>	1	\$167.00
-----------	--	--	-------------	---	----------

## U-BOLTS

Drivers Side U-Bolt Kit			<b>669UBK</b>	1	\$42.00
Near Side U-Bolt Kit			<b>436UBK</b>	1	\$42.00

## POLYURETHANE SPRING BUSHES

Bush Kit			<b>718UK</b>	1	\$70.00
----------	--	--	--------------	---	---------

## GREASABLE SHACKLES AND PINS

Greasable Shackle	Left Hand Side		<b>353RH</b>	1	\$70.00
Greasable Shackle	Right Hand Side		<b>353LH</b>	1	\$70.00
Greasable Pin			<b>667</b>	2	\$42.00

## REAR SUSPENSION

## SHOCK ABSORBER

Nitro Gas - Performance			<b>12648GR</b>	2	\$153.00
Foam Cell - Performance			<b>24648FE</b>	2	\$222.00
Foam Cell Pro - Performance			<b>45648FE</b>	2	\$305.00

## LEAF SPRINGS

	Est. Lift	Additional Load			
Heavy - Drivers Side	50mm	0 - 400kg	<b>NISS012CD/S</b>	1	\$527.00
Heavy - Near Side	50mm	0 - 400kg	<b>NISS012CN/S</b>	1	\$527.00
Extra Heavy - Drivers Side	50mm	400kg - GVM	<b>NISS012DD/S</b>	1	\$610.00
Extra Heavy - Near Side	50mm	400kg - GVM	<b>NISS012DN/S</b>	1	\$610.00

## U-BOLTS

U-Bolt Kit			<b>670UBK</b>	2	\$42.00
------------	--	--	---------------	---	---------

## POLYURETHANE SPRING BUSHES

Bush Kit			<b>719UK</b>	1	\$70.00
----------	--	--	--------------	---	---------

## GREASABLE SHACKLES AND PINS

Greasable Shackle	Left Hand Side		<b>353LH</b>	1	\$70.00
Greasable Shackle	Right Hand Side		<b>353RH</b>	1	\$70.00
Greasable Pin			<b>667</b>	2	\$42.00

## HELPER SPRINGS

Load Plus Helper Springs			<b>LP4</b>	1	\$157.00
--------------------------	--	--	------------	---	----------

## SUSPENSION KIT

Heavy - Nitro Gas	<b>NISS011CKG</b>	\$2771.00
Heavy - Foam Cell	<b>NISS011CKF</b>	\$3048.00
Heavy - Foam Cell Pro	<b>NISS011CKP</b>	\$3380.00
Extra Heavy - Nitro Gas	<b>NISS011DKG</b>	\$2854.00
Extra Heavy - Foam Cell	<b>NISS011DKF</b>	\$3131.00
Extra Heavy - Foam Cell Pro	<b>NISS011DKP</b>	\$3547.00

## SUSPENSION KIT CONTENTS

Shock Absorbers	U-Bolts
Leaf Springs	Polyurethane Spring Bushes



Product Description

Part No.

Qty  
Req

Retail  
ea Inc GST

## SUSPENSION TO SUIT NISSAN PATROL

### FRONT SUSPENSION

#### SHOCK ABSORBER

Nitro Gas - Performance			<b>12091GR</b>	2	\$153.00
Foam Cell - Performance			<b>24091FE</b>	2	\$222.00
Foam Cell - Professional			<b>24091FEP</b>	2	\$222.00
Foam Cell - Performance		Suits 4" Lift	<b>24091LFE</b>	2	\$250.00
Foam Cell - Performance		Suits 6" Lift	<b>24091LFE1</b>	2	\$278.00
Foam Cell Pro - Performance			<b>45091FE</b>	2	\$305.00
Foam Cell Pro - Professional			<b>45091FEP</b>	2	\$305.00
Foam Cell Pro - Performance		Suits 4" Lift	<b>45091LFE</b>	2	\$319.00
Foam Cell Pro - Professional		Suits 4" Lift	<b>45091LFEP</b>	2	\$319.00
Foam Cell Pro - Performance		Suits 6" Lift	<b>45091LFE1</b>	2	\$333.00

#### COIL SPRINGS

	Est. Lift	Additional Load			
Medium	50mm	0 - 50kg	<b>NISS009B</b>	1	\$250.00
Heavy	50mm	50 - 110kg	<b>NISS009C</b>	1	\$250.00
Medium - 4" Lift	100mm	0 - 100kg	<b>NISS026B</b>	1	\$388.00
Medium - 6" Lift	150mm	0 - 100kg	<b>NISS043B</b>	1	\$458.00

#### STEERING DAMPER

Foam Cell	Pre 8/1989	<b>3534</b>	1	\$167.00
Foam Cell	8/1989+	<b>3536</b>	1	\$167.00

#### CASTER CORRECTION

2° Offset Bush Kit - Polyurethane		<b>1144SK</b>	1	\$153.00
2° Offset Bush Kit - Rubber		<b>1144RK</b>	1	\$153.00
5° Offset Plate Kit		<b>CPLATE003</b>	1	\$222.00
Radius Arm Spacer	15mm	<b>833WT</b>	1	\$84.00
4° Drop Box		<b>DBOX003</b>	1	\$388.00

#### CROSSMEMBER SPACER

6mm / 12mm Spacer Kit		<b>1002K</b>	1	\$97.00
-----------------------	--	--------------	---	---------

#### STEERING RODS

Adjustable Drag Link		<b>ADL003</b>	1	\$485.00
Track Rod		<b>ATRO03</b>	1	\$485.00

#### ADJUSTABLE PANHARD ROD

Right Hand Drive Rod		<b>PANHARD003</b>	1	\$319.00
Left Hand Drive Rod		<b>PANHARD008</b>	1	\$319.00

#### SWAY BAR LINK

Extended Sway Bar Link	Suits 1-3" Lift	<b>SBEXT006</b>	2	\$84.00
Extended Sway Bar Link	Suits 4-7" Lift	<b>SBEXT003</b>	2	\$84.00

#### COIL SPACER

Polyurethane 15mm	Provides 10mm Lift	<b>PATF15</b>	2	\$28.00
Polyurethane 30mm	Provides 25mm Lift	<b>PATF30</b>	2	\$42.00

#### BRAKE HOSE

Extended Brake Hose		<b>BHOSE003</b>	1	\$70.00
---------------------	--	-----------------	---	---------

### REAR SUSPENSION

#### SHOCK ABSORBER

Nitro Gas - Performance			<b>12094GR</b>	2	\$153.00
Foam Cell - Performance			<b>24094FE</b>	2	\$222.00
Foam Cell - Professional			<b>24094FEP</b>	2	\$222.00
Foam Cell - Performance		Suits 4" Lift	<b>24094LFE</b>	2	\$250.00
Foam Cell - Professional		Suits 4" Lift	<b>24094LFEP</b>	2	\$250.00
Foam Cell - Performance		Suits 6" Lift	<b>24094LFE1</b>	2	\$278.00
Foam Cell Pro - Performance			<b>45094FE</b>	2	\$305.00
Foam Cell Pro - Professional			<b>45094FEP</b>	2	\$305.00
Foam Cell Pro - Performance		Suits 4" Lift	<b>45094LFE</b>	2	\$319.00
Foam Cell Pro - Professional		Suits 4" Lift	<b>45094LFEP</b>	2	\$319.00
Foam Cell Pro - Performance		Suits 6" Lift	<b>45094LFE1</b>	2	\$333.00

# Nissan Patrol

Y60 GQ LWB Wagon  
1988 to 1998



Product Description	Part No.	Qty Req	Retail ea Inc GST
<b>COIL SPRINGS</b>			
Medium			
Medium - 4" Lift			
Medium - 6" Lift			
Heavy			
Heavy - 4"Lift			
Heavy - 6"Lift			
Extra Heavy			
Est. Lift	Additional Load		
50mm	0 - 200kg	NISS010B	1
100mm	0 - 300kg	NISS027B	1
150mm	0 - 300kg	NISS044B	1
50mm	200 - 400kg	NISS010C	1
50mm	400 - 600kg	NISS020C	1
100mm	400kg - GVM	NISS027C	1
150mm	400kg - GVM	NISS044C	1
50mm	600kg - GVM	NISS020D	1
Price			
			\$250.00
			\$388.00
			\$458.00
			\$264.00
			\$278.00
			\$388.00
			\$458.00
			\$416.00
<b>PANHARD ROD</b>			
Adjustable Panhard Rod	PANHARD004	1	\$319.00
<b>ADJUSTABLE TRAILING ARM</b>			
Upper Trailing Arm	UTA003	2	\$208.00
Lower Trailing Arm	LTA003	2	\$264.00
<b>SWAY BAR LINK</b>			
Extended Sway Bar Link	Suits 1-3"Lift	SBEXT006	2
Extended Sway Bar Link	Suits 4-7"Lift	SBEXT003	2
Price			
			\$84.00
			\$84.00
<b>COIL SPACER</b>			
Polyurethane 15mm	Provides 10mm Lift	PATR15	2
Polyurethane 30mm	Provides 25mm Lift	PATR30	2
Price			
			\$28.00
			\$42.00
<b>BRAKE HOSE</b>			
Extended Brake Hose	BHOSE004	1	\$70.00
<b>BRACKET KIT</b>			
Coil Drop Out Cone	IDOC003	1	\$250.00
Coil Retainer Kit	ICRO03	1	\$125.00
<b>BUSH KIT</b>			
Rubber Suspension Arm Bush Kit	W/ Standard Radius Arm Bushes	839RK	1
Rubber Suspension Arm Bush Kit	W/ Offset Radius Arm Bushes	839CRK	1
Price			
			\$402.00
			\$402.00

## SUSPENSION KIT

Medium - Nitro Gas			NISS009BKG	\$1109.00
Medium - Foam Cell			NISS009BKF	\$1386.00
Medium - Foam Cell	4"Lift	RHD	NISS026BKF	\$4045.00
Medium - Foam Cell	4"Lift	LHD	NISS026BKFL	\$4045.00
Medium - Foam Cell	6"Lift	RHD	NISS043BKF	\$4295.00
Medium - Foam Cell	6"Lift	LHD	NISS043BKFL	\$4295.00
Medium - Foam Cell Pro			NISS009BKP	\$1718.00
Medium - Foam Cell Pro	4"Lift	RHD	NISS026BKP	\$4322.00
Medium - Foam Cell Pro	4"Lift	LHD	NISS026BKPL	\$4322.00
Medium - Foam Cell Pro	6"Lift	RHD	NISS043BKP	\$4516.00
Medium - Foam Cell Pro	6"Lift	LHD	NISS043BKPL	\$4516.00
Heavy - Nitro Gas			NISS009CKG	\$1123.00
Heavy - Foam Cell			NISS009CKF	\$1400.00
Heavy - Foam Cell	4"Lift	RHD	NISS026CKF	\$4045.00
Heavy - Foam Cell	4"Lift	LHD	NISS026CKFL	\$4045.00
Heavy - Foam Cell	6"Lift	RHD	NISS043CKF	\$4295.00
Heavy - Foam Cell	6"Lift	LHD	NISS043CKFL	\$4295.00
Heavy - Foam Cell Pro			NISS009CKP	\$1732.00
Heavy - Foam Cell Pro	4"Lift	RHD	NISS026CKP	\$4322.00
Heavy - Foam Cell Pro	4"Lift	LHD	NISS026CKPL	\$4322.00
Heavy - Foam Cell Pro	6"Lift	RHD	NISS043CKP	\$4516.00
Heavy - Foam Cell Pro	6"Lift	LHD	NISS043CKPL	\$4516.00
Extra Heavy - Nitro Gas			NISS020CKG	\$1136.00
Extra Heavy - Foam Cell			NISS020CKF	\$1413.00
Extra Heavy - Foam Cell Pro			NISS020CKP	\$1746.00
Super Heavy - Nitro Gas			NISS024DKG	\$1275.00
Super Heavy - Foam Cell			NISS024DKF	\$1552.00
Super Heavy - Foam Cell Pro			NISS024DKP	\$1884.00

• 4" and 6" lifts may not be legal for on-road use in your area, certification may be required for on-road use

• Due to the extreme nature of 4" and 6" lifts, further modifications may be required, and will vary between vehicles

Such modifications are entirely the owners responsibility. Ironman 4x4 accept no responsibility for any damage or injury caused by use of the these products

### 50MM SUSPENSION KIT CONTENTS

Shock Absorbers

Coil Springs

### 4" AND 6" SUSPENSION KIT CONTENTS

Shock Absorbers

Coil Springs

Panhard Rods

Sway Bar Links

Caster Plates

Brake Hoses

Adjustable Trailing Arms



Product Description

Part No.

Qty  
Req

Retail  
ea Inc GST

## SUSPENSION TO SUIT NISSAN PATROL

### FRONT SUSPENSION

#### SHOCK ABSORBER

Nitro Gas - Performance			<b>12091GR</b>	2	\$153.00
Foam Cell - Performance			<b>24091FE</b>	2	\$222.00
Foam Cell - Professional			<b>24091FEP</b>	2	\$222.00
Foam Cell - Performance		Suits 5" Lift	<b>24091LFE</b>	2	\$250.00
Foam Cell - Performance		Suits 7" Lift	<b>24091LFE1</b>	2	\$278.00
Foam Cell Pro - Performance			<b>45091FE</b>	2	\$305.00
Foam Cell Pro - Professional			<b>45091FEP</b>	2	\$305.00
Foam Cell Pro - Performance		Suits 5" Lift	<b>45091LFE</b>	2	\$319.00
Foam Cell Pro - Professional		Suits 5" Lift	<b>45091LFE1</b>	2	\$319.00
Foam Cell Pro - Performance		Suits 7" Lift	<b>45091LFE1</b>	2	\$333.00

#### COIL SPRINGS

	Est. Lift	Additional Load			
Medium	50mm	0 - 50kg	<b>NISS007B</b>	1	\$250.00
Medium - 5" Lift	125mm	0 - 100kg	<b>NISS026B</b>	1	\$388.00
Medium - 7" Lift	175mm	0 - 100kg	<b>NISS043B</b>	1	\$458.00
Heavy	50mm	50 - 110kg	<b>NISS009B</b>	1	\$250.00

#### STEERING DAMPER

Foam Cell	Pre 8/1989	<b>3534</b>	1	\$167.00
Foam Cell	8/1989+	<b>3536</b>	1	\$167.00

#### CASTER CORRECTION

2° Offset Bush Kit - Polyurethane		<b>1144SK</b>	1	\$153.00
2° Offset Bush Kit - Rubber		<b>1144RK</b>	1	\$153.00
5° Offset Plate Kit		<b>CPLATE003</b>	1	\$222.00
Radius Arm Spacer	15mm	<b>833WT</b>	1	\$84.00
4° Drop Box		<b>DBOX003</b>	1	\$388.00

#### CROSSMEMBER SPACER

6mm / 12mm Spacer Kit		<b>1002K</b>	1	\$97.00
-----------------------	--	--------------	---	---------

#### STEERING RODS

Adjustable Drag Link		<b>ADL003</b>	1	\$485.00
Track Rod		<b>ATRO03</b>	1	\$485.00

#### ADJUSTABLE PANHARD ROD

Right Hand Drive Rod		<b>PANHARD003</b>	1	\$319.00
Left Hand Drive Rod		<b>PANHARD008</b>	1	\$319.00

#### SWAY BAR LINK

Extended Sway Bar Link	Suits 1-3" Lift	<b>SBEXT006</b>	2	\$84.00
Extended Sway Bar Link	Suits 4-7" Lift	<b>SBEXT003</b>	2	\$84.00

#### COIL SPACER

Polyurethane 15mm	Provides 10mm Lift	<b>PATF15</b>	2	\$28.00
Polyurethane 30mm	Provides 25mm Lift	<b>PATF30</b>	2	\$42.00

#### BRAKE HOSE

Extended Brake Hose		<b>BHOSE003</b>	1	\$70.00
---------------------	--	-----------------	---	---------

### REAR SUSPENSION

#### SHOCK ABSORBER

Nitro Gas - Performance		<b>12094GR</b>	2	\$153.00
Foam Cell - Performance		<b>24094FE</b>	2	\$222.00
Foam Cell - Professional		<b>24094FEP</b>	2	\$222.00
Foam Cell - Performance		<b>24094LFE</b>	2	\$250.00
Foam Cell - Professional		<b>24094LFE1</b>	2	\$250.00
Foam Cell - Performance		<b>24094LFE1</b>	2	\$278.00
Foam Cell Pro - Performance		<b>45094FE</b>	2	\$305.00
Foam Cell Pro - Professional		<b>45094FEP</b>	2	\$305.00
Foam Cell Pro - Performance		<b>45094LFE</b>	2	\$319.00
Foam Cell Pro - Professional		<b>45094LFE1</b>	2	\$319.00
Foam Cell Pro - Performance		<b>45094LFE1</b>	2	\$333.00

# Nissan Patrol



Y60 GQ SWB Wagon  
1988 to 1998

Product Description	Part No.	Qty Req	Retail ea Inc GST
<b>COIL SPRINGS</b>			
Medium		Est. Lift	Additional Load
Medium - 5" Lift	NISS008B	50mm	0 - 200kg
Medium - 5" Lift	NISS027B	125mm	0 - 300kg
Medium - 7" Lift	NISS044B	175mm	0 - 300kg
Heavy	NISS010B	50mm	200 - 400kg
Extra Heavy	NISS010C	55mm	400kg - GVM
<b>PANHARD ROD</b>			
Adjustable Panhard Rod	PANHARD004	1	\$319.00
<b>ADJUSTABLE TRAILING ARM</b>			
Upper Trailing Arm	UTA003	2	\$208.00
Lower Trailing Arm	LTA003	2	\$264.00
<b>SWAY BAR LINK</b>			
Extended Sway Bar Link	SBEXT006	Suits 1-3"Lift	\$84.00
Extended Sway Bar Link	SBEXT003	Suits 4-7"Lift	\$84.00
<b>COIL SPACER</b>			
Polyurethane 15mm	PATR15	Provides 10mm Lift	\$28.00
Polyurethane 30mm	PATR30	Provides 25mm Lift	\$42.00
<b>BRAKE HOSE</b>			
Extended Brake Hose	BHOSE004	1	\$70.00
<b>BRACKET KIT</b>			
Coil Drop Out Cone	IDOC003	1	\$250.00
Coil Retainer Kit	ICR003	1	\$125.00
<b>BUSH KIT</b>			
Rubber Suspension Arm Bush Kit	839RK	W/ Standard Radius Arm Bushes	\$402.00
Rubber Suspension Arm Bush Kit	839CRK	W/ Offset Radius Arm Bushes	\$402.00

## SUSPENSION KIT

Medium - Nitro Gas	NISS007BKG		\$1109.00
Medium - Foam Cell	NISS007BKF		\$1386.00
Medium - Foam Cell	NISS026BKF	5"Lift RHD	\$4045.00
Medium - Foam Cell	NISS026BKFL	5"Lift LHD	\$4045.00
Medium - Foam Cell	NISS043BKF	7"Lift RHD	\$4295.00
Medium - Foam Cell	NISS043BKFL	7"Lift LHD	\$4295.00
Medium - Foam Cell Pro	NISS007BKP		\$1718.00
Medium - Foam Cell Pro	NISS026BKP	5"Lift RHD	\$4322.00
Medium - Foam Cell Pro	NISS026BKPL	5"Lift LHD	\$4322.00
Medium - Foam Cell Pro	NISS043BKP	7"Lift RHD	\$4516.00
Medium - Foam Cell Pro	NISS043BKPL	7"Lift LHD	\$4516.00
Heavy - Nitro Gas	NISS009BKG		\$1109.00
Heavy - Foam Cell	NISS009BKF		\$1386.00
Heavy - Foam Cell Pro	NISS009BKP		\$1718.00
Extra Heavy - Nitro Gas	NISS009BKG1		\$1123.00
Extra Heavy - Foam Cell	NISS009BKF1		\$1400.00
Extra Heavy - Foam Cell Pro	NISS009BKP1		\$1732.00

• 5" and 7" lifts may not be legal for on-road use in your area, certification may be required for on-road use  
 • Due to the extreme nature of 5" and 7" lifts, further modifications may be required, and will vary between vehicles  
 Such modifications are entirely the owners responsibility. Ironman 4x4 accept no responsibility for any damage or injury caused by use of the these products

### 50MM SUSPENSION KIT CONTENTS

Shock Absorbers                      Coil Springs

### 4" AND 6" SUSPENSION KIT CONTENTS

Shock Absorbers                      Caster Plates  
 Coil Springs                              Brake Hoses  
 Panhard Rods                            Adjustable Trailing Arms  
 Sway Bar Links







Product Description

Part No.

Qty  
Req

Retail  
ea Inc GST

## SUSPENSION TO SUIT NISSAN PATROL

### FRONT SUSPENSION

**SHOCK ABSORBER**

Nitro Gas - Performance **12075GR** 2 \$153.00

**LEAF SPRINGS**

	Est. Lift	Additional Load			
Medium - Drivers Side (Petrol)	45mm	0 - 50kg	<b>NISS005BD/S</b>	1	\$375.00
Medium - Near Side (Petrol)	45mm	0 - 50kg	<b>NISS005BN/S</b>	1	\$375.00

**STEERING DAMPER**

Foam Cell **3522** 1 \$167.00

**U-BOLTS**

U-Bolt Kit	Drivers side	<b>452UBK</b>	1	\$42.00
U-Bolt Kit	Near side	<b>451UBK</b>	1	\$42.00

**POLYURETHANE SPRING BUSHES**

Bush Kit **724UK** 1 \$84.00

**GREASABLE SHACKLES AND PINS**

Greasable Shackle	Stepped Side Plates	<b>665</b>	2	\$70.00
Greasable Pin		<b>470</b>	2	\$42.00

### REAR SUSPENSION

**SHOCK ABSORBER**

Nitro Gas - Performance **12076GR** 2 \$153.00

**LEAF SPRINGS**

	Est. Lift	Additional Load			
Medium - Drivers Side	45mm	0 - 200kg	<b>NISS004BD/S</b>	1	\$402.00
Medium - Near Side	45mm	0 - 200kg	<b>NISS004BN/S</b>	1	\$402.00

**U-BOLTS**

U-Bolt Kit **453UBK** 2 \$42.00

**POLYURETHANE SPRING BUSHES**

Bush Kit **722UK** 1 \$84.00

**GREASABLE SHACKLES AND PINS**

Greasable Shackle		<b>664</b>	2	\$70.00
Greasable Pin		<b>470</b>	2	\$42.00

**HELPER SPRINGS**

Load Plus Helper Springs	<b>LP3</b>	1	\$157.00
Add-A-Leaf	<b>ISL6010</b>	1	\$167.00

**SUSPENSION KIT**

Medium - Nitro Gas **NISS005BKG** \$2494.00

### SUSPENSION KIT CONTENTS

Shock Absorbers	U-Bolts
Leaf Springs	Polyurethane Spring Bushes

## Nissan Patrol

MQ G160 (Round Headlights)  
Pre 1984

Product Description

Part No.

Qty  
ReqRetail  
ea Inc GST

## SUSPENSION TO SUIT NISSAN PATROL

## FRONT SUSPENSION

## SHOCK ABSORBER

Nitro Gas - Performance 12075GR 2 \$153.00

## LEAF SPRINGS

Medium - Drivers Side (Petrol) 45mm 0 - 50kg NISS003BD/S 1 \$375.00

Medium - Near Side (Petrol) 45mm 0 - 50kg NISS003BN/S 1 \$375.00

## STEERING DAMPER

Foam Cell 3522 1 \$167.00

## U-BOLTS

U-Bolt Kit Drivers side 452UBK 1 \$42.00

U-Bolt Kit Near side 451UBK 1 \$42.00

## STEEL SPRING BUSHES

Bush Kit 721UK 1 \$84.00

## GREASABLE SHACKLES AND PINS

Greasable Shackle Straight Side Plates 355K 2 \$70.00

Greasable Pin 470 2 \$42.00

## REAR SUSPENSION

## SHOCK ABSORBER

Nitro Gas - Performance 12076GR 2 \$153.00

## LEAF SPRINGS

Medium - Drivers Side 45mm 0 - 200kg NISS004BD/S 1 \$402.00

Medium - Near Side 45mm 0 - 200kg NISS004BN/S 1 \$402.00

## U-BOLTS

U-Bolt Kit 453UBK 2 \$42.00

## POLYURETHANE SPRING BUSHES

Bush Kit 722UK 1 \$84.00

## GREASABLE SHACKLES AND PINS

Greasable Shackle 664 2 \$70.00

Greasable Pin 470 2 \$42.00

## HELPER SPRINGS

Load Plus Helper Springs LP3 1 \$157.00

Add-A-Leaf ISL6010 1 \$167.00

## SUSPENSION KIT

Medium - Nitro Gas NISS003BKG \$2494.00

## SUSPENSION KIT CONTENTS

Shock Absorbers

U-Bolts

Leaf Springs

Polyurethane Spring Bushes



Product Description

Part No.

Qty  
Req

Retail  
ea Inc GST

## SUSPENSION TO SUIT NISSAN XTERRA

### FRONT SUSPENSION

#### SHOCK ABSORBER

Nitro Gas Strut - Performance			<b>12716GR</b>	2	\$222.00
Foam Cell Strut - Performance			<b>24716FE</b>	2	\$250.00
Foam Cell Pro Strut - Performance			<b>45716FE</b>	2	\$388.00
Foam Cell Pro Strut - Performance - Long Travel* (SEE NOTE)			<b>45716LFE *</b>	2	\$388.00

**\*NOTE: MANDATORY FITMENT** of Ironman 4x4 UCA048FA is required with Long Travel - Foam Cell Pro

- Height adjustable with Ironman 4x4 Strut Trim Packers
- Foam Cell Pro contains a single adjusting ring for driveshaft clearance

#### COIL SPRINGS

	Est. Lift	Additional Load			
Medium	35mm	0 - 50kg	<b>NISS040B</b>	1	\$250.00
Heavy	35mm	50 - 110kg	<b>NISS040C</b>	1	\$250.00

#### STRUT MOUNTS

Steel Strut Top			<b>ISST007</b>	2	\$84.00
-----------------	--	--	----------------	---	---------

#### TRIM PACKERS

5mm Strut Trim Packer	Nitro Gas / Foam Cell	<b>HILFR05 / HILFR05F</b>	2	\$28.00
10mm Strut Trim Packer	Nitro Gas / Foam Cell	<b>HILFR10 / HILFR10F</b>	2	\$28.00
15mm Strut Trim Packer	Nitro Gas / Foam Cell	<b>HILFR15 / HILFR15F</b>	2	\$28.00

• ONLY Compatible with Ironman 4x4 Struts (Except Pro), lift height subject to 2:1 motion ratio. Unnecessary fitment may lift vehicle too high

#### CONTROL ARMS

Pro-Forge Upper Control Arms			<b>UCA048FA</b>	1	\$882.00
------------------------------	--	--	-----------------	---	----------

### REAR SUSPENSION

#### SHOCK ABSORBER

Nitro Gas - Performance			<b>12717GR</b>	2	\$153.00
Foam Cell - Performance			<b>24717FE</b>	2	\$222.00
Foam Cell - Professional			<b>24717FEP</b>	2	\$222.00
Foam Cell Pro - Performance			<b>45717FE</b>	2	\$305.00
Foam Cell Pro - Professional			<b>45717FEP</b>	2	\$305.00

#### LEAF SPRINGS

	Est. Lift	Additional Load			
Medium	45mm	0 - 300kg	<b>NISS047B</b>	2	\$375.00

#### U-BOLTS

U-Bolt Kit			<b>416UBK</b>	2	\$42.00
------------	--	--	---------------	---	---------

#### POLYURETHANE SPRING BUSHES

Bush Kit			<b>769UK</b>	1	\$84.00
----------	--	--	--------------	---	---------

#### GREASABLE SHACKLES AND PINS

Greasable Shackle			<b>797-1</b>	2	\$56.00
-------------------	--	--	--------------	---	---------

#### HELPER SPRINGS

Load Plus Helper Springs			<b>LP2</b>	1	\$157.00
Add-A-Leaf			<b>ISL6010</b>	1	\$167.00

### SUSPENSION KIT

Medium - Nitro Gas		<b>NISS047BKG</b>	\$1912.00
Medium - Foam Cell		<b>NISS047BKF</b>	\$2106.00
Medium - Foam Cell Pro		<b>NISS047BKP</b>	\$2549.00

• Specify front Coil Springs when ordering

### SUSPENSION KIT CONTENTS

Shock Absorbers	Coil Springs	Polyurethane Spring Bushes
Leaf Springs	U-Bolts	





T30  
2001 to 9/2007

**SUSPENSION TO SUIT**

# Nissan X-Trail

Product Description

Part No.

Qty  
Req

Retail  
ea Inc GST

## SUSPENSION TO SUIT NISSAN X-TRAIL

### FRONT SUSPENSION

COIL SPRINGS	Est. Lift	Additional Load	Part No.	Qty Req	Retail Price
Medium	35mm	0 - 50kg	NISS038B	1	\$250.00
<b>CAMBER CORRECTION</b>					
Camber Bolt Kit			ICAMBER12	1	\$28.00

### REAR SUSPENSION

COIL SPRINGS	Est. Lift	Additional Load	Part No.	Qty Req	Retail Price
Medium	35mm	0 - 200kg	NISS039B	1	\$250.00



Product Description

DATE AVAILABLE

Part No.

Qty  
Req

Retail  
ea Inc GST

## ACCESSORIES TO SUIT RAM 1500 DT

### SLIDE-AWAY ROLL UP HARD TONNEAU COVER

Electric with Remote Control (no RamBox)		<b>ISLIDEAWAY075-E</b>	\$2599.00
Electric with Remote Control (with RamBox)		<b>ISLIDEAWAY075RB-E</b>	\$2599.00

## SUSPENSION TO SUIT RAM 1500 DT

### FRONT SUSPENSION

#### SHOCK ABSORBER

Foam Cell Pro Strut - Performance	<b>Q1 2022</b>		<b>45860FE</b>	2	\$388.00
-----------------------------------	----------------	--	----------------	---	----------

#### COIL SPRINGS

	Est. Lift	Additional Load			
Light	1.5" Lift	0 - 50kg	<b>RAM015A</b>	1	\$250.00
Medium	2" Lift	0 - 60kg	<b>RAM015B</b>	1	\$250.00
Heavy	2" Lift	60 - 110kg	<b>RAM015C</b>	1	\$250.00

#### STRUT MOUNTS

Steel Strut Top		<b>ISST075</b>	2	\$97.00
-----------------	--	----------------	---	---------

#### CONTROL ARMS

Pro-Forge Upper Control Arms		<b>UCA075FA</b>	1	\$882.00
------------------------------	--	-----------------	---	----------

### REAR SUSPENSION

#### SHOCK ABSORBER

Foam Cell Pro - Comfort	<b>Q1 2022</b>		<b>45862FEC</b>	2	\$305.00
Foam Cell Pro - Performance	<b>Q1 2022</b>		<b>45862FE</b>	2	\$305.00

#### COIL SPRINGS

	Est. Lift	Additional Load			
Light	1.5" Lift	0 - 200kg	<b>RAM016A</b>	1	\$250.00
Medium	2" Lift	0 - 300kg	<b>RAM016B</b>	1	\$250.00
Heavy	2" Lift	200 - 500kg	<b>RAM016C</b>	1	\$250.00

### SUSPENSION KIT

Light - Foam Cell Pro	<b>Q1 2022</b>	1.5" Lift	<b>RAM017AKP</b>	\$1884.00
Medium - Foam Cell Pro	<b>Q1 2022</b>	2" Lift	<b>RAM017BKP</b>	\$1884.00
Heavy - Foam Cell Pro	<b>Q1 2022</b>	2" Lift	<b>RAM017GKP</b>	\$1884.00

### SUSPENSION KIT CONTENTS

Shock Absorbers	Coil Springs
Strut Shock Absorbers	



## Ram 1500

DS  
2014 to 2019

Product Description

Part No.

Qty  
ReqRetail  
ea Inc GST

## ACCESSORIES TO SUIT RAM 1500 DS

## SLIDE-AWAY ROLL UP HARD TONNEAU COVER

Electric with Remote Control (no RamBox)

ISLIDEAWAY075-E

\$2599.00

Electric with Remote Control (with RamBox)

ISLIDEAWAY075RB-E

\$2599.00

## SUSPENSION TO SUIT RAM 1500 DS

## FRONT SUSPENSION

## SHOCK ABSORBER

Foam Cell Pro Strut - Performance

45855FE

2

\$388.00

Foam Cell Pro Strut - Long Travel\* (SEE NOTE)

45855LFE \*

2

\$388.00

\*NOTE: MANDATORY FITMENT of UCA075FA and SBEXT075 is required with Long Travel - Foam Cell Pro Strut

## COIL SPRINGS

Est. Lift

Additional Load

Light

2" Lift

0 - 50kg

RAM015A

1

\$250.00

Medium

2" Lift

0 - 60kg

RAM015B

1

\$250.00

Heavy

2" Lift

60 - 110kg

RAM015C

1

\$250.00

## STRUT MOUNTS

Steel Strut Top

ISS075

2

\$97.00

## SWAY BAR LINK

Adjustable Sway Bar Link

SBEXT075

2

\$142.00

## CONTROL ARMS

Pro-Forge Upper Control Arms

UCA075FA

1

\$882.00

## REAR SUSPENSION

## SHOCK ABSORBER

Foam Cell Pro - Comfort

45856FEC

2

\$305.00

Foam Cell Pro - Comfort - Long Travel\* (SEE NOTE)

45856LFEC \*

2

\$305.00

Foam Cell Pro - Performance

45856FE

2

\$305.00

Foam Cell Pro - Performance - Long Travel\* (SEE NOTE)

45856LFE \*

2

\$305.00

\*NOTE: MANDATORY FITMENT of Ironman 4x4 Coil Springs are required with Long Travel - Foam Cell Pro

## COIL SPRINGS

Est. Lift

Additional Load

Light

1.5" Lift

0 - 200kg

RAM016A

1

\$250.00

Medium

2" Lift

0 - 300kg

RAM016B

1

\$250.00

Heavy

2" Lift

200 - 500kg

RAM016C

1

\$250.00

## SUSPENSION KIT

Light - Foam Cell Pro

1.5" Lift

RAM016AKP

\$2360.00

Medium - Foam Cell Pro

2" Lift

RAM016BKP

\$2360.00

Medium - Foam Cell Pro\*

2.5" Lift

RAM016BKP1

\$3330.00

Heavy - Foam Cell Pro

2" Lift

RAM016CKP

\$2360.00

Heavy - Foam Cell Pro\*

2.5" Lift

RAM016CKP1

\$3330.00

\* Adjust 45855LFE seat height to 193mm

## SUSPENSION KIT CONTENTS

Shock Absorbers

Coil Springs

Sway Bar Links

Strut Shock Absorbers

Strut Mounts

Upper Control Arms (2.5" lift kit only)



Product Description

Part No.

Qty  
Req

Retail  
ea Inc GST

## ACCESSORIES TO SUIT RENAULT ALASKAN

### STEEL WINCH BULL BARS - THAI BUILT MODEL ONLY

Commercial	BBC048	\$1648.00
Commercial Deluxe	BBCD048	\$2244.00
Polished Alloy	BBA048	\$2794.00
Proguard No Loop	BBT048-NL	\$1855.00
Proguard Single Loop Kit	BB048-SL	\$336.00
Proguard Triple Loop Kit	BB048-TL	\$404.00

### STEEL SIDE STEPS AND RAILS - FITS DUAL CAB MODELS ONLY

Side Steps	SS048	\$962.00
Side Rails	SS048 RAIL	\$317.00
Side Steps and Rails	SSR048	\$1155.00

### TOWING

Class 4 Towbar - Compatible with Factory Rear Bumper	TB048	\$581.00
Rear Protection Towbar - Full Rear Bumper Replacement	RTB048	\$1328.00
Rear Protection Towbar Plates (Pair)	RTBPLATE048	\$146.00
Towbar Wiring Loom - Plug and Play	ITBL048	\$276.00

### LOCKSAFE DRAWER SYSTEMS

Twin Drawers - 1300mm	ITD1300	\$1469.00
Single Drawer - 1300mm	ISD1300	\$891.00
Wing Kit - 1300mm*	ITDW048	\$351.00

\*Designed to suit factory tubs, will not suit ute liner without modification.

### LONG RANGE FUEL TANK

140L* - Auto/Coil Spring Diesel only	TANK048	\$1129.00
--------------------------------------	---------	-----------

\*Usable volume may differ to the stated tank capacity

### PREMIUM UNDERBODY PROTECTION

Engine Bay and Transmission - Series 1	UBP048	\$748.00
Engine Bay and Transmission - Series 2, 3 and 4	UBP048S	\$748.00

### EXHAUST SYSTEM

3" Exhaust Upgrade 2.3L - DPF Back - While Stocks Last	IEX048	\$770.00
--	--------	----------

### CANOPY - ABS PLASTIC (SIDE LIFT UP WINDOWS AND CENTRAL LOCKING REAR DOOR) - FITS 4X4 AND 4X2 DUAL CAB MODELS

White (QM1)	CANOPY013-PW	\$3856.00
Brilliant Silver (K23)	CANOPY013-BS	\$3856.00
White Diamond (QX1)	CANOPY013-WP	\$3856.00
Cosmic Black (G42)	CANOPY013-CB	\$3856.00

### CANOPY - PINNACLE SMOOTH FINISH FIBREGLASS (SIDE LIFT UP WINDOWS AND CENTRAL LOCKING REAR DOOR) - FITS 4X4 AND 4X2 DUAL CAB MODELS

Pre-Primed	CANFIBRE048-P	\$2899.00*
White (QM1)	CANFIBRE048-PW	\$3399.00
Brilliant Silver (K23)	CANFIBRE048-BS	\$3399.00
Hornet Gold (EAU)	CANFIBRE048-HG	\$3399.00
White Diamond (QX1)	CANFIBRE048-WP	\$3399.00
Cosmic Black (G42)	CANFIBRE048-CB	\$3399.00
Slate Grey (K21)	CANFIBRE048-SG	\$3399.00

\*Pre-primed canopies, plus colour coding.

### CANOPY - PINNACLE 2 FIBREGLASS (SIDE LIFT UP WINDOWS AND CENTRAL LOCKING REAR DOOR) - FITS 4X4 AND 4X2 DUAL CAB MODELS

Pre-Primed	ICANOPY048-P	\$2899.00*
Brilliant Silver (K23)	ICANOPY048-BS	\$3399.00
Cosmic Black (G42)	ICANOPY048-CB	\$3399.00
White (QM1)	ICANOPY048-PW	\$3399.00
Slate Grey (K21)	ICANOPY048-SG	\$3399.00
White Diamond (QX1)	ICANOPY048-WP	\$3399.00

### DIFF BREATHER KIT

Diff Breather Kit	IDIFFBRE	\$115.00
-------------------	----------	----------





2017+

## Renault Alaskan

## Product Description

Part No.

Qty  
ReqRetail  
ea Inc GST

## SUSPENSION TO SUIT RENAULT ALASKAN

## FRONT SUSPENSION

## SHOCK ABSORBER

Nitro Gas Strut - Performance	12716GR	2	\$222.00
Foam Cell Strut - Performance	24716FE	2	\$250.00
Foam Cell Pro Strut - Performance	45716FE	2	\$388.00
Foam Cell Pro Strut - Performance - Long Travel* (SEE NOTE)	45716LFE *	2	\$388.00

\*NOTE: MANDATORY FITMENT of Ironman 4x4 UCA048FA is required with Long Travel - Foam Cell Pro

- Height adjustable with Ironman 4x4 Strut Trim Packers
- Foam Cell Pro contains a single adjusting ring for driveshaft clearance

## COIL SPRINGS

	Est. Lift	Additional Load			
Standard Height	0mm	0 - 50kg	NISS040A	1	\$250.00
Light	20mm	0 - 50kg	NISS040B	1	\$250.00
Medium	35mm	0 - 80kg	NISS040C	1	\$250.00
Heavy	40mm	50 - 110kg	NISS040D	1	\$250.00

• Series 3+ vehicles are produced with a 25mm increased ride height from factory. The resulting lift estimated with Ironman 4x4 suspension will be 25mm less than stated above

## STRUT MOUNTS

Steel Strut Top	ISST007	2	\$84.00
-----------------	---------	---	---------

## TRIM PACKERS

5mm Strut Trim Packer	Nitro Gas / Foam Cell	HILFR05 / HILFR05F	2	\$28.00
10mm Strut Trim Packer	Nitro Gas / Foam Cell	HILFR10 / HILFR10F	2	\$28.00
15mm Strut Trim Packer	Nitro Gas / Foam Cell	HILFR15 / HILFR15F	2	\$28.00

• ONLY Compatible with Ironman 4x4 Struts (except Pro), lift height subject to 2:1 motion ratio. Unnecessary fitment may lift vehicle too high

## CONTROL ARMS

Pro-Forge Upper Control Arms	UCA048FA	1	\$882.00
------------------------------	----------	---	----------

## REAR SUSPENSION

## SHOCK ABSORBER

Nitro Gas - Performance	12728GR	2	\$153.00
Foam Cell - Performance	24728FE	2	\$222.00
Foam Cell - Professional	24728FEP	2	\$222.00
Foam Cell Pro - Comfort	45728FEC	2	\$305.00
Foam Cell Pro - Performance	45728FE	2	\$305.00
Foam Cell Pro - Professional	45728FEP	2	\$305.00

## COIL SPRINGS

	Est. Lift	Additional Load			
Light	20mm	0 - 200kg	NISS058A	1	\$250.00
Medium	40mm	0 - 300kg	NISS058B	1	\$250.00
Heavy	40mm	300kg - 600kg	NISS058C	1	\$250.00
Extra Heavy	45mm	600kg - GVM	NISS058D	1	\$250.00

• Series 3+ vehicles are produced with a 25mm increased ride height from factory. The resulting lift estimated with Ironman 4x4 suspension will be 25mm less than stated above

## COIL SPACER

Polyurethane 20mm	NAVR20	2	\$42.00
-------------------	--------	---	---------

## SPACER KIT

Sway Bar and Headlight Bracket Extension Kit	1204K	1	\$97.00
--	-------	---	---------

## SUSPENSION KIT

Medium - Nitro Gas	NISS058BKG	\$1344.00
Medium - Foam Cell	NISS058BKF	\$1538.00
Medium - Foam Cell Pro	NISS058BKP	\$1981.00
Heavy - Nitro Gas	NISS058CKG	\$1344.00
Heavy - Foam Cell	NISS058CKF	\$1538.00
Heavy - Foam Cell Pro	NISS058CKP	\$1981.00
Extra Heavy - Nitro Gas	NISS058DKG	\$1344.00
Extra Heavy - Foam Cell	NISS058DKF	\$1538.00
Extra Heavy - Foam Cell Pro	NISS058DKP	\$1981.00

• Specify front Coil Springs when ordering

• Series 3+ vehicles are produced with a 25mm increased ride height from factory. The resulting lift estimated with Ironman 4x4 suspension will be 25mm less than stated above

## SUSPENSION KIT CONTENTS

Shock Absorbers	Strut Shock Absorbers
Coil Springs	Sway Bar and Headlight Bracket Kit



# Renault Duster

2010+



Product Description

Part No.

Qty  
Req

Retail  
ea Inc GST

## SUSPENSION TO SUIT RENAULT DUSTER

### FRONT SUSPENSION

#### SHOCK ABSORBER

Nitro Gas Strut - Performance

**12747GR** 2 \$278.00

#### COIL SPRINGS

Medium Est. Lift 40mm Additional Load 0 - 50kg

**REN001B** 1 \$250.00

#### CAMBER CORRECTION

Camber Bolt Kit

**ICAMBER12** 1 \$28.00

### REAR SUSPENSION

#### SHOCK ABSORBER

Nitro Gas Strut - Performance

**12748GR** 2 \$278.00

#### COIL SPRINGS

Medium Est. Lift 40mm Additional Load 0 - 200kg

**REN002B** 1 \$250.00

#### CAMBER CORRECTION

Camber Bolt Kit

**ICAMBER12** 1 \$28.00

### SUSPENSION KIT

Medium - Nitro Gas

**REN001BKG** \$1663.00

### SUSPENSION KIT CONTENTS

Shock Absorbers

Camber Correction

Coil Springs



Q200 / Q201 / Q205 / Q215  
10/2018+

# SsangYong Musso

Product Description

Part No.

Qty  
Req

Retail  
ea Inc GST

## ACCESSORIES TO SUIT SSANGYONG MUSSO

### STEEL WINCH BULL BARS

Commercial Deluxe (Not suitable for Q215 Model)

• Winch with Steel Cable and Roller Fairlead is not suitable - Use Winch with Synthetic Rope and Alloy Hawse only

BBCD071

\$2244.00

### PREMIUM UNDERBODY PROTECTION

Engine Bay

UBP201SY

\$526.00

### DIFF BREATHER KIT

Diff Breather Kit

IDIFFBRE

\$115.00





# SsangYong Musso

Q200 SWB  
10/2018+



Product Description

Part No.

Qty  
Req

Retail  
ea Inc GST

## SUSPENSION TO SUIT SSANGYONG MUSSO

### FRONT SUSPENSION

#### SHOCK ABSORBER

Nitro Gas Strut - Performance

**12823GR** 2 \$222.00

#### COIL SPRINGS

	Est. Lift	Additional Load			
Medium	30mm	0-50kg	<b>SSANG003B</b>	1	\$250.00
Heavy	35mm	50-100kg	<b>SSANG003C</b>	1	\$250.00

• Estimated lift is 15mm less in 2020+ models due to factory OEM height increase

### REAR SUSPENSION

#### SHOCK ABSORBER

Nitro Gas - Performance

**12824GR** 2 \$153.00

#### COIL SPRINGS

	Est. Lift	Additional Load			
Medium	35mm	0 - 200kg	<b>SSANG004B</b>	1	\$250.00
Heavy	40mm	200 - 400kg	<b>SSANG004C</b>	1	\$250.00

• Estimated lift is 15mm less in 2020+ models due to factory OEM height increase

### SUSPENSION KIT

Medium - Nitro Gas

**SSANG004BKG** \$1247.00

Heavy - Nitro Gas

**SSANG004CKG** \$1247.00

• Specify front Coil Springs when ordering

• Estimated lift is 15mm less in 2020+ models due to factory OEM height increase

### SUSPENSION KIT CONTENTS

Shock Absorbers

Coil Springs

Strut Shock Absorbers



Q201 / Q215 LWB (Coil)  
10/2018+

# SsangYong Musso

Product Description

Part No.

Qty  
ReqRetail  
ea Inc GST

## SUSPENSION TO SUIT SSANGYONG MUSSO

### FRONT SUSPENSION

#### SHOCK ABSORBER

Nitro Gas Strut - Performance

12823GR

2

\$222.00

#### COIL SPRINGS

	Est. Lift	Additional Load			
Medium	30mm	0 - 50kg	SSANG003B	1	\$250.00
Heavy	35mm	50 - 100kg	SSANG003C	1	\$250.00

- Estimated lift is 15mm less in 2020+ models due to factory OEM height increase

### REAR SUSPENSION

#### SHOCK ABSORBER

Nitro Gas - Performance

12825GR

2

\$153.00

#### COIL SPRINGS

	Est. Lift	Additional Load			
Medium	35mm	0 - 200kg	SSANG006B	1	\$250.00
Heavy	40mm	200 - 400kg	SSANG006C	1	\$250.00

- Estimated lift is 15mm less in 2020+ models due to factory OEM height increase

### SUSPENSION KIT

Medium - Nitro Gas

SSANG006BKG

\$1134.00

Heavy - Nitro Gas

SSANG006CKG

\$1134.00

- Specify front Coil Springs when ordering

- Estimated lift is 15mm less in 2020+ models due to factory OEM height increase

### SUSPENSION KIT CONTENTS

Shock Absorbers

Coil Springs

Strut Shock Absorbers

# SsangYong Musso

Q201 / Q205 / Q215 LWB (Leaf)  
10/2018+



Product Description

Part No.

Qty  
Req

Retail  
ea Inc GST

## SUSPENSION TO SUIT SSANGYONG MUSSO

### FRONT SUSPENSION

#### SHOCK ABSORBER

Nitro Gas Strut - Performance

**12823GR** 2 \$222.00

#### COIL SPRINGS

	Est. Lift	Additional Load			
Medium	30mm	0-50kg	<b>SSANG003B</b>	1	\$250.00
Heavy	35mm	50-100kg	<b>SSANG003C</b>	1	\$250.00

• Estimated lift is 15mm less in 2020+ models due to factory OEM height increase

### REAR SUSPENSION

#### SHOCK ABSORBER

Nitro Gas - Performance

**12826GR** 2 \$153.00

#### LEAF SPRINGS

	Est. Lift	Additional Load			
Medium	45mm	0-300kg	<b>SSANG005B</b>	2	\$375.00
Heavy	50mm	300kg-GVM	<b>SSANG005C</b>	2	\$402.00

#### U-BOLTS

U-Bolt Kit **1105UBK** 2 \$42.00

#### POLYURETHANE SPRING BUSHES

Bush Kit **1153UK** 1 \$167.00

### SUSPENSION KIT

Medium - Nitro Gas	<b>SSANG005BKG</b>	\$1451.00
Heavy - Nitro Gas	<b>SSANG005CKG</b>	\$1491.00

### SUSPENSION KIT CONTENTS

Shock Absorbers	Coil Springs	U-Bolts
Strut Shock Absorbers	Leaf Springs	Polyurethane Spring Bushes



1996 to 2006

# SUSPENSION TO SUIT SsangYong Musso / Korando

Product Description

Part No.

Qty  
Req

Retail  
ea Inc GST

## SUSPENSION TO SUIT SSANGYONG MUSSO / KORANDO

### FRONT SUSPENSION

#### SHOCK ABSORBER

Nitro Gas - Performance	<b>12667GR</b>	2	\$153.00
Foam Cell - Performance	<b>24667FE</b>	2	\$222.00

#### TORSION BAR

Uprated Torsion Bars	<b>SSANG001</b>	1	\$582.00
----------------------	-----------------	---	----------

• Minimum 60mm downward suspension travel required after adjustment

### REAR SUSPENSION

#### SHOCK ABSORBER

Nitro Gas - Performance	<b>12661GRS</b>	2	\$153.00
Foam Cell - Performance	<b>24661FES</b>	2	\$222.00

#### COIL SPRINGS

	Est. Lift	Additional Load		
Medium	45mm	0 -200kg	<b>SSANG002B</b>	1

### SUSPENSION KIT

Medium - Nitro Gas	<b>SSANG002BKG</b>	\$1441.00
Medium - Foam Cell	<b>SSANG002BKF</b>	\$1718.00

### SUSPENSION KIT CONTENTS

Shock Absorbers                      Torsion Bars  
Coil Springs

# SsangYong Rexton

Y400  
10/2018+



Product Description

Part No.

Qty  
Req

Retail  
ea Inc GST

## ACCESSORIES TO SUIT SSANGYONG REXTON

### STEEL WINCH BULL BARS

Commercial Deluxe

**BBCD071**

\$2244.00

• Winch with Steel Cable and Roller Fairlead is not suitable - Use Winch with Synthetic Rope and Alloy Hawse only

### PREMIUM UNDERBODY PROTECTION

Engine Bay

**UBP201SY**

\$526.00

### DIFF BREATHER KIT

Diff Breather Kit

**IDIFFBRE**

\$115.00





Y400 / Y450  
2018+

# SsangYong Rexton

Product Description

Part No.

Qty  
ReqRetail  
ea Inc GST

## SUSPENSION TO SUIT SSANGYONG REXTON

### FRONT SUSPENSION

#### SHOCK ABSORBER

Nitro Gas - Performance

**12823GR**

2

\$222.00

#### COIL SPRINGS

Est. Lift

Additional Load

Medium

30mm

0-50kg

**SSANG003B**

1

\$250.00

Heavy

35mm

50-100kg

**SSANG003C**

1

\$250.00

### REAR SUSPENSION

#### SHOCK ABSORBER

Nitro Gas - Performance

**12828GR**

2

\$153.00

#### COIL SPRINGS

Est. Lift

Additional Load

Medium

40mm

0-200kg

**SSANG010B**

1

\$250.00

### SUSPENSION KIT

Medium - Nitro Gas

**SSANG010BKG**

\$1247.00

### SUSPENSION KIT CONTENTS

Shock Absorbers

Coil Springs

Strut Shock Absorbers



Product Description

Part No.

Qty  
Req

Retail  
ea Inc GST

## SUSPENSION TO SUIT SUBARU FORESTER

### FRONT SUSPENSION

#### SHOCK ABSORBER

	Est. Lift	Additional Load			
Nitro Gas Strut Assembly Left - Medium	50mm	0 - 50kg	<b>12830007GR LH</b>	1	\$471.00
Nitro Gas Strut Assembly Right - Medium	50mm	0 - 50kg	<b>12830007GR RH</b>	1	\$471.00
Nitro Gas Strut Assembly Left - Heavy	50mm	50 - 80kg	<b>12830007GRP LH</b>	1	\$471.00
Nitro Gas Strut Assembly Right - Heavy	50mm	50 - 80kg	<b>12830007GRP RH</b>	1	\$471.00

• Strut Assembly includes pre-assembled Coil Springs, Shock Absorber and Strut Top Cap

### REAR SUSPENSION

#### SHOCK ABSORBER

	Est. Lift	Additional Load			
Nitro Gas Strut Assembly - Medium	50mm	0 - 200kg	<b>12832008GR</b>	2	\$459.00
Nitro Gas Strut Assembly - Heavy	50mm	200kg - GVM	<b>12832008GRP</b>	2	\$459.00

• Strut Assembly includes pre-assembled Coil Springs, Shock Absorber and Strut Top Cap

#### SPACER KIT

Sway Bar Relocation Kit			<b>1216K</b>	1	\$116.00
Sub Frame Alignment Kit			<b>1215K</b>	1	\$295.00

### SUSPENSION KIT

Medium - Nitro Gas			<b>SUB007BKG</b>		\$2269.00
Heavy - Nitro Gas			<b>SUB007CKG</b>		\$2269.00

### SUSPENSION KIT CONTENTS

Left / Right Front Strut Assemblies	Rear Subframe Alignment Kit
Rear Strut Assemblies	Sway Bar Relocation Kit



SF5, GX, RX, GT  
1997 to 2013

# Subaru Forester

Product Description

Part No.

Qty  
Req

Retail  
ea Inc GST

## SUSPENSION TO SUIT SUBARU FORESTER

### FRONT SUSPENSION

#### COIL SPRINGS

	Est. Lift	Additional Load			
Medium - 1997 - 2001	35mm	0 - 50kg	<b>SUB001B</b>	1	\$250.00
Medium - 2002 - 2008	35mm	0 - 50kg	<b>SUB003B</b>	1	\$250.00
Medium - 2008 - 2013	20mm	0 - 50kg	<b>SUB005B</b>	1	\$250.00

#### CAMBER CORRECTION

Camber Bolt Kit			<b>ICAMBER14</b>	1	\$28.00
-----------------	--	--	------------------	---	---------

### REAR SUSPENSION

#### COIL SPRINGS

	Est. Lift	Additional Load			
Medium - 1997 - 2001	35mm	0 - 200kg	<b>SUB002B</b>	1	\$250.00
Medium - 2002 - 2008	35mm	0 - 200kg	<b>SUB004B</b>	1	\$250.00
Medium - 2008 - 2013	20mm	0 - 200kg	<b>SUB006B</b>	1	\$250.00

• Not suitable for self leveling suspension models

#### CAMBER CORRECTION

Camber Bolt Kit			<b>ICAMBER14</b>	1	\$28.00
-----------------	--	--	------------------	---	---------



Product Description

Part No.

Qty  
Req

Retail  
ea Inc GST

## SUSPENSION TO SUIT SUBARU OUTBACK

### FRONT SUSPENSION

#### SHOCK ABSORBER

	Est. Lift	Additional Load			
Nitro Gas Strut Assembly Left - Medium (2015-2019)	50mm	0 - 50kg	<b>12833009GR LH</b>	1	\$471.00
Nitro Gas Strut Assembly Right- Medium (2015-2019)	50mm	0 - 50kg	<b>12833009GR RH</b>	1	\$471.00
Nitro Gas Strut Assembly Left - Heavy (2015-2019)	50mm	50 - 80kg	<b>12833009GRP LH</b>	1	\$471.00
Nitro Gas Strut Assembly Right- Heavy (2015-2019)	50mm	50 - 80kg	<b>12833009GRP RH</b>	1	\$471.00
Nitro Gas Strut Assembly Left - Medium (2020+)	50mm	0 - 50kg	<b>12831009GR LH</b>	1	\$471.00
Nitro Gas Strut Assembly Right- Medium (2020+)	50mm	0 - 50kg	<b>12831009GR RH</b>	1	\$471.00
Nitro Gas Strut Assembly Left - Heavy (2020+)	50mm	50 - 80kg	<b>12831009GRP LH</b>	1	\$471.00
Nitro Gas Strut Assembly Right- Heavy (2020+)	50mm	50 - 80kg	<b>12831009GRP RH</b>	1	\$471.00

• Strut Assembly includes pre-assembled Coil Springs, Shock Absorber and Strut Top Cap

### REAR SUSPENSION

#### SHOCK ABSORBER

	Est. Lift	Additional Load			
Nitro Gas Strut Assembly - Medium (2015-2019)	50mm	0 - 200kg	<b>12834010GR</b>	2	\$459.00
Nitro Gas Strut Assembly - Heavy (2015-2019)	50mm	200kg - GVM	<b>12834010GRP</b>	2	\$459.00
Nitro Gas Strut Assembly - Medium (2020+)	50mm	0 - 200kg	<b>12834014GR</b>	2	\$459.00
Nitro Gas Strut Assembly - Heavy (2020+)	50mm	200kg - GVM	<b>12834014GRP</b>	2	\$459.00

• Strut Assembly includes pre-assembled Coil Springs, Shock Absorber and Strut Top Cap

#### SPACER KIT

Sub Frame Alignment Kit		<b>1215K</b>	1	\$295.00
-------------------------	--	--------------	---	----------

### SUSPENSION KIT

Medium - Nitro Gas (2015-2019)	<b>SUB009BKG</b>	\$2154.00
Heavy - Nitro Gas (2015-2019)	<b>SUB009CKG</b>	\$2154.00
Medium - Nitro Gas (2020+)	<b>SUB009BKG1</b>	\$2154.00
Heavy - Nitro Gas (2020+)	<b>SUB009CKG1</b>	\$2154.00

### SUSPENSION KIT CONTENTS

Left / Right Front Strut Assemblies      Rear Subframe Alignment Kit  
Rear Strut Assemblies



2018+

## Subaru XV Crosstrek

Product Description

Part No.

Qty  
ReqRetail  
ea Inc GST

## SUSPENSION TO SUIT SUBARU XV CROSSTREK

## FRONT SUSPENSION

SHOCK ABSORBER	Est. Lift	Additional Load	Part No.	Qty	Retail Price
Nitro Gas Strut Assembly Left - Medium	50mm	0 - 50kg	12835011GR LH	1	\$471.00
Nitro Gas Strut Assembly Right- Medium	50mm	0 - 50kg	12835011GR RH	1	\$471.00
Nitro Gas Strut Assembly Left - Heavy	50mm	50 - 80kg	12835011GRP LH	1	\$471.00
Nitro Gas Strut Assembly Right- Heavy	50mm	50 - 80kg	12835011GRP RH	1	\$471.00

• Strut Assembly includes pre-assembled Coil Springs, Shock Absorber and Strut Top Cap

## REAR SUSPENSION

SHOCK ABSORBER	Est. Lift	Additional Load	Part No.	Qty	Retail Price
Nitro Gas Strut Assembly - Medium	50mm	0 - 200kg	12836012GR	2	\$459.00
Nitro Gas Strut Assembly - Heavy	50mm	200kg - GVM	12836012GRP	2	\$459.00

• Strut Assembly includes pre-assembled Coil Springs, Shock Absorber and Strut Top Cap

## SPACER KIT

Sway Bar Relocation Kit			1216K	1	\$116.00
Sub Frame Alignment Kit			1215K	1	\$295.00

## EXHAUST HANGER KIT

Exhaust Hanger Rubber			IEXH4075	3	\$14.00
-----------------------	--	--	----------	---	---------

## SUSPENSION KIT

Medium - Nitro Gas			SUB011BKG		\$2313.00
Heavy - Nitro Gas			SUB011CKG		\$2313.00

## SUSPENSION KIT CONTENTS

Left / Right Front Strut Assemblies  
Rear Strut Assemblies

Rear Subframe Alignment Kit  
Sway Bar Relocation Kit

Exhaust Hanger Rubbers





Product Description

Part No.

Qty  
Req

Retail  
ea Inc GST

## ACCESSORIES TO SUIT SUZUKI JIMNY

### STEEL WINCH BULL BARS

Commercial Deluxe*	BBCD070	\$1825.00
Jimny Special*	BBS070	\$1825.00
Driving Light Patch Loom	IPL070	\$31.00

- Winch with Steel Cable and Roller Fairlead is not suitable - Use Winch with Synthetic Rope and Alloy Hawse only
- Uses factory fog/DRL Lights. Suits factory flares

\* Black textured paint

### RECOVERY POINTS - IRONMAN 4X4 BULL BAR ONLY

Recovery Points - 5000kg Rating (Pair)	IRP070	\$287.00
--	--------	----------

### ALLOY ROOF RACKS

Cage Style - 1.4m x 1.25m	IRRCAGE14-ALLOY	\$983.00
Trade Style - 1.4m x 1.25m (Open end)	IRROPEN14-ALLOY	\$971.00

### ROOF RACK - MOUNTING KITS

Gutter Mount Feet - 100mm (8 Feet)	IRRFEET100	\$198.00
------------------------------------	------------	----------

### PREMIUM UNDERBODY PROTECTION

Transfer Case, Driveline and Exhaust	UBP070	\$526.00
--------------------------------------	--------	----------

### SNORKEL

2018+	ISNORKEL070	\$418.00
-------	-------------	----------

### SEAT COVER

Canvas Comfort - Front	ICSC070F	\$401.00
Canvas Comfort - Rear	ICSC070R	\$401.00

### DIFF BREATHER KIT

Diff Breather Kit	IDIFFBRE	\$115.00
-------------------	----------	----------

GJ  
2018+

## Product Description

## Part No.

Qty  
ReqRetail  
ea Inc GST

## SUSPENSION TO SUIT SUZUKI JIMNY

## FRONT SUSPENSION

## SHOCK ABSORBER

Nitro Gas - Performance 12759GR 2 \$153.00

## STEERING DAMPER

Foam Cell 3542 1 \$167.00

## COIL SPRINGS

	Est. Lift	Additional Load	Part No.	Qty	Price
Medium	50mm	0 - 50kg	SUZ009B	1	\$250.00
Heavy	50mm	50 - 80kg	SUZ009C	1	\$250.00

## PANHARD ROD

Adjustable Panhard Rod LHD PANHARD017L 1 \$319.00

Adjustable Panhard Rod RHD PANHARD017 1 \$319.00

## CHASSIS DROPMEMBER

Front Crossmember Drop Brackets IDM009 1 \$139.00

## OFFSET CASTER BUSH KIT

Offset Bush Kit Rubber 2 Degree offset 1146RK 1 \$125.00

## BUMP STOP

Extended Bump Stop 1219R 2 \$39.00

• Must install 1219R extended bump stop when fitting 1146RK

• Must install IDM009 Dropmember when fitting 1146RK and 12759GR

## REAR SUSPENSION

## SHOCK ABSORBER

Nitro Gas - Performance 12760GR 2 \$153.00

## COIL SPRINGS

	Est. Lift	Additional Load	Part No.	Qty	Price
Medium - RHD	50mm	0 - 200kg	SUZ010B	1	\$250.00
Medium - LHD	50mm	0 - 200kg	SUZ011B	1	\$250.00
Heavy - RHD	50mm	200 - 400kg	SUZ010C	1	\$250.00
Heavy - LHD	50mm	200 - 400kg	SUZ011C	1	\$250.00

• SUZ010 are staggered height for Japan Spec vehicles, SUZ011 are equal height for Euro spec vehicles

## PANHARD ROD

Adjustable Panhard Rod PANHARD018 1 \$319.00

## BRAKE HOSE

Extended Brake Hose Left side BHOSE009 1 \$70.00

## SPACER KIT

Extended Headlight Sensor Bracket 1211K 1 \$14.00

• Must install BHOSE009 and 1211K when fitting 12760GR

## SUSPENSION KIT

Medium - Nitro Gas SUZ010BKG \$1330.00

Heavy - Nitro Gas SUZ010CKG \$1330.00

## SUSPENSION KIT CONTENTS

Shock Absorbers

Extended Brake Hose

Front Crossmember Drop Brackets

Coil Springs

Extended Headlight Sensor Bracket



OPTIONS AVAILABLE FOR THIS VEHICLE - SEE PAGE 384



Product Description

Part No.

Qty  
Req

Retail  
ea Inc GST

## ACCESSORIES TO SUIT SUZUKI JIMNY

**STEEL WINCH BULL BARS**

Commercial Deluxe

• Winch with Steel Cable and Roller Fairlead is not suitable - Use Winch with Synthetic Rope and Alloy Hawse only

**BBCD063**

\$2244.00

**DIFF BREATHER KIT**

Diff Breather Kit

**IDIFFBRE**

\$115.00

# Suzuki Jimny

SN413  
1998 to 2018



Product Description

Part No.

Qty  
Req

Retail  
ea Inc GST

## SUSPENSION TO SUIT SUZUKI JIMNY

### FRONT SUSPENSION

#### SHOCK ABSORBER

Nitro Gas - Performance			<b>12759GR</b>	2	\$153.00
-------------------------	--	--	----------------	---	----------

#### STEERING DAMPER

Foam Cell		Includes Adaptor Kit	<b>3521S</b>	1	\$167.00
-----------	--	----------------------	--------------	---	----------

#### COIL SPRINGS

Medium	Est. Lift 50mm	Additional Load 0 -50kg	<b>SUZ009B</b>	1	\$250.00
--------	-------------------	----------------------------	----------------	---	----------

#### OFFSET CASTER BUSH KIT

Offset Bush Kit Rubber		2 Degree offset	<b>1146RK</b>	1	\$125.00
------------------------	--	-----------------	---------------	---	----------

### REAR SUSPENSION

#### SHOCK ABSORBER

Nitro Gas - Performance			<b>12760GR</b>	2	\$153.00
-------------------------	--	--	----------------	---	----------

#### COIL SPRINGS

Medium - Japan Spec	Est. Lift 50mm	Additional Load 0 -200kg	<b>SUZ010B</b>	1	\$250.00
---------------------	-------------------	-----------------------------	----------------	---	----------

Medium - Euro Spec	50mm	0 -200kg	<b>SUZ011B</b>	1	\$250.00
--------------------	------	----------	----------------	---	----------

• SUZ010B are staggered height for Japan Spec vehicles, SUZ011B are equal height for Euro spec vehicles

### SUSPENSION KIT

Medium - Nitro Gas			<b>SUZ009BKG</b>		\$1109.00
--------------------	--	--	------------------	--	-----------

• Specify rear Coil Springs when ordering

### SUSPENSION KIT CONTENTS

Shock Absorbers

Coil Springs

# Suzuki Sierra

SJ80 (Coil)  
1997+



Product Description

Part No.

Qty  
Req

Retail  
ea Inc GST

## SUSPENSION TO SUIT SUZUKI SIERRA

### FRONT SUSPENSION

#### COIL SPRINGS

	Est. Lift	Additional Load	Part No.	Qty	Retail Price
Medium	35mm	0 -40kg	<b>SUZ007B</b>	1	\$250.00

#### OFFSET CASTER BUSH KIT

Offset Bush Kit Rubber	2 Degree offset		<b>1146RK</b>	1	\$125.00
------------------------	-----------------	--	---------------	---	----------

### REAR SUSPENSION

#### COIL SPRINGS

	Est. Lift	Additional Load	Part No.	Qty	Retail Price
Medium	35mm	0 -200kg	<b>SUZ008B</b>	1	\$250.00



## Suzuki Sierra

Samurai LJ, SJ (Leaf)  
1981+

Product Description

Part No.

Qty  
ReqRetail  
ea Inc GST

## SUSPENSION TO SUIT SUZUKI SIERRA

## FRONT SUSPENSION

## SHOCK ABSORBER

Nitro Gas - Performance

12085GR

2

\$153.00

## LEAF SPRINGS

Est. Lift Additional Load

Medium - Drivers Side

50mm

0 - 50kg

SUZ001BD/S

1

\$208.00

Medium - Near Side

50mm

0 - 50kg

SUZ001BN/S

1

\$208.00

## STEERING DAMPER

Foam Cell

3530

1

\$167.00

## U-BOLTS

U-Bolt Kit

Drivers side

654UBK

1

\$42.00

U-Bolt Kit

Near side

655UBK

1

\$42.00

## POLYURETHANE SPRING BUSHES

Bush Kit

734UK

1

\$84.00

## REAR SUSPENSION

## SHOCK ABSORBER

Nitro Gas - Performance

12086GR

2

\$153.00

## LEAF SPRINGS

Est. Lift Additional Load

Medium

50mm

0 - 200kg

SUZ002B

2

\$250.00

Medium - Optional +20mm

50mm

0 - 200kg

SUZ002BD/S

1

\$250.00

• Optional D/S spring to offset uneven weight distribution, eg. Spare Wheel

## U-BOLTS

U-Bolt Kit

655UBK

2

\$42.00

## POLYURETHANE SPRING BUSHES

Bush Kit

734UK

1

\$84.00

## HELPER SPRINGS

Load Plus Helper Springs

LP5

1

\$157.00

## SUSPENSION KIT

Medium - Nitro Gas

SUZ001BKG

\$1857.00

• Specify rear spring configuration when ordering

## SUSPENSION KIT CONTENTS

Shock Absorbers

U-Bolts

Leaf Springs

Polyurethane Spring Bushes

# Suzuki Grand Vitara

8/2005 to 2015



Product Description

Part No.

Qty  
Req

Retail  
ea Inc GST

## ACCESSORIES TO SUIT SUZUKI GRAND VITARA

**STEEL WINCH BULL BARS - 2012 DIESEL MANUAL ONLY - NOT COMPATIBLE WITH V6 MODEL**

Commercial Deluxe - Diesel Manual Only

**BBCD046**

\$2244.00

Protector - Diesel Manual Only - *While Stocks Last*

**BBT046**

\$2271.00

**UNDERBODY PROTECTION**

Engine Bay and Transmission - (2005 to 2015) - *While Stocks Last*

**IUP011K**

\$563.00

**DIFF BREATHER KIT**

Diff Breather Kit

**IDIFFBRE**

\$115.00





8/2005 to 2015

# Suzuki Grand Vitara

Product Description

Part No.

Qty  
Req

Retail  
ea Inc GST

## SUSPENSION TO SUIT SUZUKI GRAND VITARA

### FRONT SUSPENSION

#### SHOCK ABSORBER

Nitro Gas Strut - Performance	McPherson Strut	<b>12721GR</b>	2	\$250.00
-------------------------------	-----------------	----------------	---	----------

#### COIL SPRINGS

	Est. Lift	Additional Load		
Medium	40mm	0 - 50kg	<b>SUZ019B</b>	1
Heavy or Diesel, or 2.7L	40mm	50 - 100kg	<b>SUZ019C</b>	1

#### CAMBER CORRECTION

Camber Bolt Kit	<b>ICAMBER14</b>	1	\$28.00
-----------------	------------------	---	---------

### REAR SUSPENSION

#### SHOCK ABSORBER

Nitro Gas - Performance	<b>12722GR</b>	2	\$153.00
-------------------------	----------------	---	----------

#### COIL SPRINGS

	Est. Lift	Additional Load		
Medium - SWB (GV3)	40mm	0 - 200kg	<b>SUZ020A</b>	1
Medium - LWB	40mm	0 - 200kg	<b>SUZ020B</b>	1
Heavy - LWB	40mm	200 - 400kg	<b>SUZ020C</b>	1

### SUSPENSION KIT

Medium - Nitro Gas	SWB GV3	<b>SUZ019AKG</b>	\$1330.00
Medium - Nitro Gas	LWB	<b>SUZ019BKG</b>	\$1330.00
Heavy - Nitro Gas	LWB	<b>SUZ019CKG</b>	\$1330.00

•SWB refers 3 door vehicles, LWB refers 5 door vehicles

• Monocoque constructed vehicles such as Suzuki Grand Vitara can be subject to increased NVH (Noise) with upgraded suspension installed

• Specify front Coil Springs when ordering

### SUSPENSION KIT CONTENTS

Shock Absorbers

Strut Shock Absorbers

Coil Springs

Camber Correction



# Suzuki Grand Vitara

1988 to 7/2005



Product Description

Part No.

Qty  
Req

Retail  
ea Inc GST

## SUSPENSION TO SUIT SUZUKI GRAND VITARA

### FRONT SUSPENSION

#### SHOCK ABSORBER

Nitro Gas Strut - Performance	Full replacement strut	<b>12083GR</b>	2	\$222.00
-------------------------------	------------------------	----------------	---	----------

#### COIL SPRINGS

	Est. Lift	Additional Load		
Medium - 4 Cyl Carb	35mm	0 - 50kg	<b>SUZ005B</b>	1
Medium - V6 / 4 Cyl Inj	35mm	0 - 50kg	<b>SUZ015B</b>	1
Medium - XL7	35mm	0 - 50kg	<b>SUZ017B</b>	1

#### CAMBER CORRECTION

Camber Bolt Kit		<b>ICAMBER12</b>	1	\$28.00
-----------------	--	------------------	---	---------

### REAR SUSPENSION

#### SHOCK ABSORBER

Nitro Gas - Performance	SWB	<b>12089GR</b>	2	\$153.00
-------------------------	-----	----------------	---	----------

Nitro Gas - Performance	LWB	<b>12658GR</b>	2	\$153.00
-------------------------	-----	----------------	---	----------

#### COIL SPRINGS

	Est. Lift	Additional Load		
Medium - SWB	35mm	0 - 200kg	<b>SUZ013B</b>	1
Medium - LWB	35mm	0 - 200kg	<b>SUZ016B</b>	1
Medium - XL7	35mm	0 - 200kg	<b>SUZ018B</b>	1

### SUSPENSION KIT

Medium - Nitro Gas	SWB	<b>SUZ013BKG</b>	\$1275.00
--------------------	-----	------------------	-----------

Medium - Nitro Gas	LWB	<b>SUZ016BKG</b>	\$1275.00
--------------------	-----	------------------	-----------

Medium - Nitro Gas	XL7	<b>SUZ018BKG</b>	\$1275.00
--------------------	-----	------------------	-----------

•SWB suits short wheel base vehicles

•LWB Suits long wheel base vehicles

• Specify front Coil Springs when ordering

### SUSPENSION KIT CONTENTS

Shock Absorbers

Strut Shock Absorbers

Coil Springs

Camber Correction



1988+

# Suzuki Vitara

Product Description

Part No.

Qty  
Req

Retail  
ea Inc GST

## SUSPENSION TO SUIT SUZUKI VITARA

### FRONT SUSPENSION

#### SHOCK ABSORBER

Nitro Gas Strut - Performance	Full replacement strut	<b>12083GR</b>	2	\$222.00
-------------------------------	------------------------	----------------	---	----------

#### COIL SPRINGS

	Est. Lift	Additional Load		
Medium - SWB	35mm	0 - 50kg	<b>SUZ003B</b>	1
Medium - LWB	35mm	0 - 50kg	<b>SUZ005B</b>	1

#### CAMBER CORRECTION

Camber Bolt Kit		<b>ICAMBER12</b>	1	\$28.00
-----------------	--	------------------	---	---------

### REAR SUSPENSION

#### SHOCK ABSORBER

Nitro Gas - Performance	SWB	<b>12089GR</b>	2	\$153.00
Nitro Gas - Performance	LWB	<b>12658GR</b>	2	\$153.00

#### COIL SPRINGS

	Est. Lift	Additional Load		
Medium - SWB	35mm	0 - 200kg	<b>SUZ004B</b>	1
Medium - LWB	35mm	0 - 200kg	<b>SUZ006B</b>	1

### SUSPENSION KIT

Medium - Nitro Gas	SWB	<b>SUZ003BKG</b>	\$1275.00
Medium - Nitro Gas	LWB	<b>SUZ005BKG</b>	\$1275.00

•SWB suits short wheel base vehicles

•LWB Suits long wheel base vehicles

### SUSPENSION KIT CONTENTS

Shock Absorbers  
Coil Springs

Strut Shock Absorbers  
Camber Correction



# Toyota 4Runner

Gen 5, N280  
2009+



Product Description

DATE AVAILABLE

Part No.

Qty  
Req

Retail  
ea Inc GST

## ACCESSORIES TO SUIT TOYOTA 4RUNNER

### STEEL WINCH BULL BARS

Raid Stubby Bumper

Q4 2021

BBR078

-

*• Raid Bull Bars are compatible with Ironman 4x4 Lightbars, refer below for available options*

### LIGHTING OPTIONS - TO SUIT RAID BULL BARS

75W Bright Sabre Single Row Lightbar 524mm (20") Straight

ILBSR003BW

1

\$195.00

### STEEL SIDE STEPS

Raid Rock Slider

Q4 2021

SS078

\$959.00

### TOWING

Raid Rear Bumper\*

Q4 2021

RTB078

\$1055.00

*\* Compatible with Ironman 4x4 Cube Lights, refer below for available options*

### LIGHTING OPTIONS - TO SUIT RAID REAR BARS (4 CUBE LIGHTS PER VEHICLE)

20W Bright Cube Spot Beam LED Cube Light - 70 x 64mm (Each) - Clear

ILED20B

2

\$61.00

20W Bright Cube Spot Beam LED Cube Light - 70 x 64mm (Each) - Amber

ILED20BA

2

\$61.00

20W Bright Cube Flood Beam LED Cube Light - 70 x 64mm (Each) - Clear

ILED20BF

2

\$61.00

20W Bright Cube Flood Beam LED Cube Light - 70 x 64mm (Each) - Amber

ILED20BFA

2

\$61.00

20W Bright Cube Flood Beam LED Cube Light - 70 x 64mm (Each) - Red

ILED20BFR

2

\$61.00

### PREMIUM UNDERBODY PROTECTION

Engine Bay and Transmission for models without KDSS

UBP047

\$748.00

### DIFF BREATHER KIT

Diff Breather Kit

IDIFFBRE

\$115.00





Gen 4 and 5, N210-N280  
2003+

# Toyota 4Runner

Product Description

Part No.

Qty  
ReqRetail  
ea Inc GST

## SUSPENSION TO SUIT TOYOTA 4RUNNER

### FRONT SUSPENSION

#### SHOCK ABSORBER

Nitro Gas Strut - Performance			<b>12710GR</b>	2	\$222.00
Foam Cell Strut - Performance			<b>24710FE</b>	2	\$250.00
Foam Cell Pro Strut - Performance			<b>45710FE</b>	2	\$388.00

• Height adjustable with Ironman 4x4 Strut Trim Packers.

#### COIL SPRINGS

	Est. Lift	Additional Load			
Light	30mm	0 - 50kg	<b>TOY055B</b>	1	\$250.00
Medium	45mm	0 - 50kg	<b>TOY065B</b>	1	\$250.00
Heavy	45mm	50 - 110kg	<b>TOY065C</b>	1	\$250.00

#### STRUT MOUNTS

Steel Strut Top			<b>ISST001</b>	2	\$84.00
-----------------	--	--	----------------	---	---------

#### TRIM PACKERS

5mm Strut Trim Packer	Nitro Gas / Foam Cell	<b>HILFR05 / HILFR05F</b>	2	\$28.00
10mm Strut Trim Packer	Nitro Gas / Foam Cell	<b>HILFR10 / HILFR10F</b>	2	\$28.00
15mm Strut Trim Packer	Nitro Gas / Foam Cell	<b>HILFR15 / HILFR15F</b>	2	\$28.00

• ONLY Compatible with Ironman 4x4 Struts (except Pro), lift height subject to 2:1 motion ratio. Unnecessary fitment may lift vehicle too high

#### CONTROL ARMS

Pro-Forge Upper Control Arms			<b>UCA001FA</b>	1	\$882.00
------------------------------	--	--	-----------------	---	----------

#### SPACER KIT

Sway Bar Spacer			<b>1198K</b>	1	\$97.00
Offset Sway Bar Bracket			<b>1209K</b>	1	\$139.00

### REAR SUSPENSION

#### SHOCK ABSORBER

Nitro Gas - Comfort			<b>12682GRC</b>	2	\$153.00
Nitro Gas - Professional			<b>12682GRP</b>	2	\$153.00
Foam Cell - Comfort			<b>24682FEC</b>	2	\$222.00
Foam Cell - Professional			<b>24682FEP</b>	2	\$222.00
Foam Cell Pro - Comfort			<b>45682FEC</b>	2	\$305.00
Foam Cell Pro - Professional			<b>45682FEP</b>	2	\$305.00

#### COIL SPRINGS

	Est. Lift	Additional Load			
Light	30mm	0 - 300kg	<b>TOY056A</b>	1	\$250.00
Medium	45mm	0 - 300kg	<b>TOY056B</b>	1	\$250.00
Heavy	45mm	300kg - GVM	<b>TOY056C</b>	1	\$250.00
Air Bag Delete Kit			<b>1218ADK</b>	1	\$436.00

#### COIL SPACER

Polyurethane 20mm			<b>LCPR20</b>	2	\$28.00
Polyurethane 25mm			<b>LCPR25</b>	2	\$42.00

#### PANHARD ROD

Adjustable Panhard Rod			<b>PANHARD015</b>	1	\$319.00
------------------------	--	--	-------------------	---	----------

#### SWAY BAR LINK

Extended Sway Bar Link			<b>SBEXT006</b>	2	\$84.00
KDSS Spacer Brackets			<b>1220K</b>	1	\$142.00

### SUSPENSION KIT

Light - Nitro Gas	<b>TOY055AKG</b>	\$1247.00
Light - Foam Cell	<b>TOY055AKF</b>	\$1441.00
Light - Foam Cell Pro	<b>TOY055AKP</b>	\$2023.00
Medium - Nitro Gas	<b>TOY055BKG</b>	\$1247.00
Medium - Foam Cell	<b>TOY055BKF</b>	\$1441.00
Medium - Foam Cell Pro	<b>TOY055BKP</b>	\$2023.00
Heavy - Nitro Gas	<b>TOY055CKG</b>	\$1247.00
Heavy - Foam Cell	<b>TOY055CKF</b>	\$1441.00
Heavy - Foam Cell Pro	<b>TOY055CKP</b>	\$2023.00

• Specify front Coil Springs when ordering

### SUSPENSION KIT CONTENTS

Shock Absorbers	Strut Shock Absorbers
Coil Springs	Offset Sway Bar Bracket (Pro Kits Only)



Product Description

Part No.

Qty  
Req

Retail  
ea Inc GST

## SUSPENSION TO SUIT TOYOTA 4RUNNER

### FRONT SUSPENSION

#### SHOCK ABSORBER

Nitro Gas Strut - Performance			<b>12691GR</b>	2	\$222.00
Foam Cell Strut - Performance			<b>24691FE</b>	2	\$250.00
Foam Cell Pro Strut - Performance			<b>45691FE</b>	2	\$388.00

• Height adjustable with Ironman 4x4 Strut Trim Packers.

#### COIL SPRINGS

	Est. Lift	Additional Load			
Medium	45mm	0 - 50kg	<b>TOY038B</b>	1	\$250.00
Heavy	45mm	50 - 110kg	<b>TOY038C</b>	1	\$250.00

#### STRUT MOUNTS

Steel Strut Top			<b>ISST001</b>	2	\$84.00
-----------------	--	--	----------------	---	---------

#### TRIM PACKERS

5mm Strut Trim Packer	Nitro Gas / Foam Cell	<b>HILFR05 / HILFR05F</b>	2	\$28.00
10mm Strut Trim Packer	Nitro Gas / Foam Cell	<b>HILFR10 / HILFR10F</b>	2	\$28.00
15mm Strut Trim Packer	Nitro Gas / Foam Cell	<b>HILFR15 / HILFR15F</b>	2	\$28.00

• ONLY Compatible with Ironman 4x4 Struts (except Pro), lift height subject to 2:1 motion ratio. Unnecessary fitment may lift vehicle too high

### REAR SUSPENSION

#### SHOCK ABSORBER

Nitro Gas - Performance			<b>12661GR</b>	2	\$153.00
Foam Cell - Performance			<b>24661FE</b>	2	\$222.00
Foam Cell Pro - Performance			<b>45661FE</b>	2	\$305.00

#### COIL SPRINGS

	Est. Lift	Additional Load			
Light	30mm	0 - 200kg	<b>TOY039A</b>	1	\$250.00
Medium	45mm	0 - 300kg	<b>TOY039B</b>	1	\$250.00
Heavy	45mm	300kg - GVM	<b>TOY039C</b>	1	\$250.00

#### COIL SPACER

Polyurethane 20mm			<b>LCF20</b>	2	\$28.00
Polyurethane 30mm			<b>LCF30</b>	2	\$42.00

### SUSPENSION KIT

Light - Nitro Gas	<b>TOY038AKG</b>	\$1247.00
Light - Foam Cell	<b>TOY038AKF</b>	\$1441.00
Light - Foam Cell Pro	<b>TOY038AKP</b>	\$1884.00
Medium - Nitro Gas	<b>TOY038BKG</b>	\$1247.00
Medium - Foam Cell	<b>TOY038BKF</b>	\$1441.00
Medium - Foam Cell Pro	<b>TOY038BKP</b>	\$1884.00
Heavy - Nitro Gas	<b>TOY038BKG1</b>	\$1247.00
Heavy - Foam Cell	<b>TOY038BKF1</b>	\$1441.00
Heavy - Foam Cell Pro	<b>TOY038BKP1</b>	\$1884.00

• Specify front Coil Springs when ordering

### SUSPENSION KIT CONTENTS

Shock Absorbers	Strut Shock Absorbers
Coil Springs	

# Toyota 4Runner



Gen 2 Surf, N130 V6 (Coil)  
1990 to 1997

Product Description

Part No.

Qty  
Req

Retail  
ea Inc GST

## SUSPENSION TO SUIT TOYOTA 4RUNNER

### FRONT SUSPENSION

#### SHOCK ABSORBER

Nitro Gas - Performance	12088GR	2	\$153.00
Foam Cell - Performance	24088FE	2	\$222.00

#### TORSION BAR

Uprated Torsion Bars	TOY026	1	\$416.00
----------------------	--------	---	----------

• Minimum 60mm downward suspension travel required after adjustment.

#### STEERING DAMPER

Foam Cell	3533	1	\$167.00
-----------	------	---	----------

### REAR SUSPENSION

#### SHOCK ABSORBER

Nitro Gas - Comfort	12637GRC	2	\$153.00
Nitro Gas - Performance	12637GR	2	\$153.00
Foam Cell - Comfort	24637FEC	2	\$222.00
Foam Cell - Performance	24637FE	2	\$222.00

#### COIL SPRINGS

	Est. Lift	Additional Load			
Medium	45mm	0 -200kg	TOY023B	1	\$250.00
Heavy	45mm	200kg - GVM	TOY023C	1	\$250.00

### SUSPENSION KIT

Medium - Nitro Gas	TOY023BKG	\$1275.00
Medium - Foam Cell	TOY023BKF	\$1552.00
Heavy - Nitro Gas	TOY023CKG	\$1275.00
Heavy - Foam Cell	TOY023CKF	\$1552.00

### SUSPENSION KIT CONTENTS

Shock Absorbers	Torsion Bars
Coil Springs	



# Toyota 4Runner

Gen 1, N60 (Leaf)  
1988 to 1997



Product Description

Part No.

Qty  
Req

Retail  
ea Inc GST

## SUSPENSION TO SUIT TOYOTA 4RUNNER

### FRONT SUSPENSION

#### SHOCK ABSORBER

Nitro Gas - Performance	<b>12088GR</b>	2	\$153.00
Foam Cell - Performance	<b>24088FE</b>	2	\$222.00

#### TORSION BAR

Up-rated Torsion Bars	<b>TOY026</b>	1	\$416.00
-----------------------	---------------	---	----------

• Minimum 60mm downward suspension travel required after adjustment

#### STEERING DAMPER

Foam Cell	<b>3533</b>	1	\$167.00
-----------	-------------	---	----------

### REAR SUSPENSION

#### SHOCK ABSORBER

Nitro Gas - Comfort	<b>12650GRC</b>	2	\$153.00
Nitro Gas - Performance	<b>12650GR</b>	2	\$153.00
Foam Cell - Comfort	<b>24650FEC</b>	2	\$222.00
Foam Cell - Performance	<b>24650FE</b>	2	\$222.00
Foam Cell - Professional	<b>24650FEP</b>	2	\$222.00

#### LEAF SPRINGS

	Est. Lift	Additional Load			
Medium	50mm	0-300kg	<b>TOY011B</b>	2	\$375.00
Heavy	50mm	300kg - GVM	<b>TOY011C</b>	2	\$402.00

• 1200mm Leaf Length

#### U-BOLTS

U-Bolt Kit	<b>437UBK</b>	2	\$42.00
------------	---------------	---	---------

#### POLYURETHANE SPRING BUSHES

Bush Kit	<b>733UK</b>	1	\$70.00
----------	--------------	---	---------

#### GREASABLE SHACKLES AND PINS

Greasable Shackle	Straight Shackle	<b>386</b>	2	\$56.00
Greasable Shackle	Straight Shackle Extended 5mm	<b>386-2</b>	2	\$56.00
Greasable Pin		<b>385</b>	2	\$42.00

#### HELPER SPRINGS

Load Plus Helper Springs	<b>LP2</b>	1	\$157.00
Add-A-Leaf	<b>ISL6010</b>	1	\$167.00

### SUSPENSION KIT

Medium - Nitro Gas	<b>TOY011BKG</b>	\$1926.00
Medium - Foam Cell	<b>TOY011BKF</b>	\$2203.00
Heavy - Nitro Gas	<b>TOY011CKG</b>	\$1981.00
Heavy - Foam Cell	<b>TOY011CKF</b>	\$2258.00

### SUSPENSION KIT CONTENTS

Shock Absorbers	Torsion Bars	Polyurethane Spring Bushes
Leaf Springs	U-Bolts	





2019 to 2021

**SUSPENSION TO SUIT**

# Toyota Rav4

Product Description

Part No.

Qty  
Req

Retail  
ea Inc GST

## SUSPENSION TO SUIT TOYOTA RAV4

### FRONT SUSPENSION

#### COIL SPRINGS

	Est. Lift	Additional Load	Part No.	Qty	Retail Price
Comfort	35mm	0-50kg	TOY080A	1	\$250.00

### REAR SUSPENSION

#### COIL SPRINGS

	Est. Lift	Additional Load	Part No.	Qty	Retail Price
Comfort	35mm	0-200kg	TOY082A	1	\$250.00

# Toyota FJ Cruiser

2006+



Product Description

Part No.

Qty  
Req

Retail  
ea Inc GST

## ACCESSORIES TO SUIT TOYOTA FJ CRUISER

### STEEL WINCH BULL BARS

Commercial Deluxe

BBCD037

\$2244.00

### PREMIUM UNDERBODY PROTECTION

Engine Bay and Transmission

UBP047

\$748.00

### UNDERBODY PROTECTION

Engine Bay and Transmission - *While Stocks Last*

IUP003K

\$563.00

### DIFF BREATHER KIT

Diff Breather Kit

IDIFFBRE

\$115.00



2006+

# Toyota FJ Cruiser

Product Description

Part No.

Qty  
ReqRetail  
ea Inc GST

## SUSPENSION TO SUIT TOYOTA FJ CRUISER

### FRONT SUSPENSION

#### SHOCK ABSORBER

Nitro Gas Strut - Performance			<b>12710GR</b>	2	\$222.00
Foam Cell Strut - Performance			<b>24710FE</b>	2	\$250.00
Foam Cell Pro Strut - Performance			<b>45710FE</b>	2	\$388.00

- Height adjustable with Ironman 4x4 Strut Trim Packers

- Foam Cell Pro, must fit 1198K spacer for Sway Bar clearance

#### COIL SPRINGS

	Est. Lift	Additional Load			
Light	30mm	0 - 50kg	<b>TOY055A</b>	1	\$250.00
Medium	45mm	0 - 50kg	<b>TOY055B</b>	1	\$250.00
Heavy	45mm	50 - 110kg	<b>TOY055C</b>	1	\$250.00

#### STRUT MOUNTS

Steel Strut Top			<b>ISST001</b>	2	\$84.00
-----------------	--	--	----------------	---	---------

#### TRIM PACKERS

5mm Strut Trim Packer	Nitro Gas / Foam Cell	<b>HILFR05 / HILFR05F</b>	2	\$28.00
10mm Strut Trim Packer	Nitro Gas / Foam Cell	<b>HILFR10 / HILFR10F</b>	2	\$28.00
15mm Strut Trim Packer	Nitro Gas / Foam Cell	<b>HILFR15 / HILFR15F</b>	2	\$28.00

- ONLY Compatible with Ironman 4x4 Struts (except Pro), lift height subject to 2:1 motion ratio. Unnecessary fitment may lift vehicle too high

#### CONTROL ARMS

Pro-Forge Upper Control Arms			<b>UCA001FA</b>	1	\$882.00
------------------------------	--	--	-----------------	---	----------

#### SPACER KIT

Sway Bar Spacer			<b>1198K</b>	1	\$97.00
Offset Sway Bar Bracket			<b>1209K</b>	1	\$139.00

### REAR SUSPENSION

#### SHOCK ABSORBER

Nitro Gas - Comfort			<b>12682GRC</b>	2	\$153.00
Nitro Gas - Performance			<b>12682GR</b>	2	\$153.00
Nitro Gas - Professional			<b>12682GRP</b>	2	\$153.00
Foam Cell - Comfort			<b>24682FEC</b>	2	\$222.00
Foam Cell - Performance			<b>24682FE</b>	2	\$222.00
Foam Cell - Professional			<b>24682FEP</b>	2	\$222.00
Foam Cell Pro - Comfort			<b>45682FEC</b>	2	\$305.00
Foam Cell Pro - Performance			<b>45682FE</b>	2	\$305.00
Foam Cell Pro - Professional			<b>45682FEP</b>	2	\$305.00

#### COIL SPRINGS

	Est. Lift	Additional Load			
Light	40mm	0 - 300kg	<b>TOY056A</b>	1	\$250.00
Medium	50mm	0 - 300kg	<b>TOY056B</b>	1	\$250.00
Heavy	50mm	300kg - GVM	<b>TOY069B</b>	1	\$250.00

#### PANHARD ROD

Adjustable Panhard Rod			<b>PANHARD015</b>	1	\$319.00
------------------------	--	--	-------------------	---	----------

#### SWAY BAR LINK

Extended Sway Bar Link			<b>SBEXT006</b>	2	\$84.00
------------------------	--	--	-----------------	---	---------

#### BUMP STOP

Internal Rubber Cone			<b>1218R</b>	2	\$129.00
----------------------	--	--	--------------	---	----------

### SUSPENSION KIT

Light - Nitro Gas	<b>TOY055AKG</b>	\$1247.00
Light - Foam Cell	<b>TOY055AKF</b>	\$1441.00
Light - Foam Cell Pro	<b>TOY055AKP</b>	\$2023.00
Medium - Nitro Gas	<b>TOY055BKG</b>	\$1247.00
Medium - Foam Cell	<b>TOY055BKF</b>	\$1441.00
Medium - Foam Cell Pro	<b>TOY055BKP</b>	\$2023.00
Heavy - Nitro Gas	<b>TOY055CKG</b>	\$1247.00
Heavy - Foam Cell	<b>TOY055CKF</b>	\$1441.00
Heavy - Foam Cell Pro	<b>TOY055CKP</b>	\$2023.00

- Specify front Coil Springs when ordering

### SUSPENSION KIT CONTENTS

Shock Absorbers	Strut Shock Absorbers
Coil Springs	Offset Sway Bar Bracket (Pro Kits Only)

# Toyota Fortuner

2015 to 9/2020  
(Facelift) 2020+



Product Description

DATE AVAILABLE

Part No.

Qty  
Req

Retail  
ea Inc GST

## ACCESSORIES TO SUIT TOYOTA FORTUNER

### STEEL WINCH BULL BARS

Commercial Deluxe - (2015 to 2/2020 Only)		<b>BBCD053</b>	\$2244.00
Commercial Deluxe - (2020+ facelift Only)	<b>Q1 2022</b>	<b>BBCD081</b>	\$2244.00
Protector - (2015 to 2/2020 Only)		<b>BBT053</b>	\$2271.00
Proguard No Loop - (2015 to 2/2020 Only) - <i>While Stocks Last</i>		<b>BBT053-NL</b>	\$1855.00
Proguard No Loop - (2020+ facelift Only)	<b>Q1 2022</b>	<b>BBT081-NL</b>	\$1855.00
Proguard Single Loop Kit - (2015 to 2/2020 Only)		<b>BB053-SL</b>	\$336.00
Proguard Single Loop Kit - (2020+ facelift Only)	<b>Q1 2022</b>	<b>BB081-SL</b>	\$336.00
Proguard Triple Loop Kit - (2015 to 2/2020 Only)		<b>BB053-TL</b>	\$404.00
Proguard Triple Loop Kit - (2020+ facelift Only)	<b>Q1 2022</b>	<b>BB081-TL</b>	\$404.00

### STEEL SIDE STEPS AND RAILS

Side Steps		<b>SS053</b>	\$962.00
Side Rails		<b>SS053 RAIL</b>	\$317.00
Side Steps and Rails		<b>SSR053</b>	\$1155.00

### RECOVERY POINTS - IRONMAN 4X4 BULL BAR ONLY

Recovery Points - 5000kg Rating (Pair)		<b>IRP051</b>	\$217.00
--	--	---------------	----------

### PREMIUM UNDERBODY PROTECTION

Engine Bay and Transmission		<b>UBP051</b>	\$748.00
-----------------------------	--	---------------	----------

### SNORKEL

2.8L Diesel		<b>ISNORKEL053</b>	\$418.00
-------------	--	--------------------	----------

### SEAT COVER

Canvas Comfort - Front		<b>ICSC053F</b>	\$401.00
Canvas Comfort - Rear		<b>ICSC053R</b>	\$401.00

### DIFF BREATHER KIT

Diff Breather Kit		<b>IDIFFBRE</b>	\$115.00
-------------------	--	-----------------	----------

## Toyota Fortuner

2015+

## Product Description

## Part No.

Qty  
ReqRetail  
ea Inc GST

## SUSPENSION TO SUIT TOYOTA FORTUNER

## FRONT SUSPENSION

## SHOCK ABSORBER

Nitro Gas Strut - Performance			<b>12730GR</b>	2	\$222.00
Foam Cell Strut - Performance			<b>24730FE</b>	2	\$250.00
Foam Cell Pro Strut - Performance			<b>45730FE</b>	2	\$388.00

- Height adjustable with Ironman 4x4 Strut Trim Packers

- Operating clearance to sway bar can be increased by installing 1210K offset sway bar bracket

## COIL SPRINGS

	Est. Lift	Additional Load			
Medium	30mm	0 - 50kg	<b>TOY055A</b>	1	\$250.00
Heavy	40mm	50 - 110kg	<b>TOY055B</b>	1	\$250.00

## STRUT MOUNTS

Steel Strut Top			<b>ISST001</b>	2	\$84.00
-----------------	--	--	----------------	---	---------

## TRIM PACKERS

5mm Strut Trim Packer	Nitro Gas / Foam Cell	<b>HILFR05 / HILFR05F</b>	2	\$28.00
10mm Strut Trim Packer	Nitro Gas / Foam Cell	<b>HILFR10 / HILFR10F</b>	2	\$28.00
15mm Strut Trim Packer	Nitro Gas / Foam Cell	<b>HILFR15 / HILFR15F</b>	2	\$28.00

- ONLY Compatible with Ironman 4x4 Struts (except Pro), lift height subject to 2:1 motion ratio. Unnecessary fitment may lift vehicle too high

## CONTROL ARMS

Pro-Forge Upper Control Arms			<b>UCA001FA</b>	1	\$882.00
------------------------------	--	--	-----------------	---	----------

## SWAY BAR

Offset Sway Bar Bracket			<b>1210K</b>	1	\$139.00
-------------------------	--	--	--------------	---	----------

## REAR SUSPENSION

## SHOCK ABSORBER

Nitro Gas - Comfort			<b>12743GRC</b>	2	\$153.00
Nitro Gas - Performance			<b>12743GR</b>	2	\$153.00
Foam Cell - Comfort			<b>24743FEC</b>	2	\$222.00
Foam Cell - Performance			<b>24743FE</b>	2	\$222.00
Foam Cell Pro - Comfort			<b>45743FEC</b>	2	\$305.00
Foam Cell Pro - Performance			<b>45743FE</b>	2	\$305.00

## COIL SPRINGS

	Est. Lift	Additional Load			
Standard	0mm	0 - 200kg	<b>TOY017S</b>	1	\$250.00
Medium	30mm	0 - 200kg	<b>TOY017A</b>	1	\$250.00
Heavy	40mm	100 - 300kg	<b>TOY017B</b>	1	\$250.00

- Possible driveline vibration may occur, use 1192K Centre Bearing Spacer Kit

## SPACER KIT

Centre Bearing Spacer Kit			<b>1192K</b>	1	\$28.00
---------------------------	--	--	--------------	---	---------

## SUSPENSION KIT

Medium - Nitro Gas	<b>TOY017AKG1</b>	\$1275.00
Medium - Foam Cell	<b>TOY017AKF1</b>	\$1469.00
Medium - Foam Cell Pro	<b>TOY017AKP1</b>	\$2051.00
Heavy - Nitro Gas	<b>TOY017BKG1</b>	\$1275.00
Heavy - Foam Cell	<b>TOY017BKF1</b>	\$1469.00
Heavy - Foam Cell Pro	<b>TOY017BKP1</b>	\$2148.00

- Specify front Coil Springs when ordering

- Possible driveline vibration may occur if raised above 40mm

## SUSPENSION KIT CONTENTS

Shock Absorbers

Strut Shock Absorbers

Offset Sway Bar Bracket (Pro Kits Only)

Coil Springs

Centre Bearing Spacer Kit



# Toyota Fortuner

2004 to 2015



Product Description

Part No.

Qty  
Req

Retail  
ea Inc GST

## ACCESSORIES TO SUIT TOYOTA FORTUNER

### STEEL WINCH BULL BARS

Commercial	<b>BBC030</b>	\$1678.00
Commercial Deluxe	<b>BBCD030</b>	\$2244.00
Protector	<b>BBT030</b>	\$2271.00
Proguard No Loop	<b>BBT030-NL</b>	\$1855.00
Proguard Single Loop Kit	<b>BB030-SL</b>	\$336.00
Proguard Triple Loop Kit	<b>BB030-TL</b>	\$404.00

### DIFF BREATHER KIT

Diff Breather Kit	<b>IDIFFBRE</b>	\$115.00
-------------------	-----------------	----------

## Toyota Fortuner

2004 to 2015

## Product Description

## Part No.

Qty  
ReqRetail  
ea Inc GST

## SUSPENSION TO SUIT TOYOTA FORTUNER

## FRONT SUSPENSION

## SHOCK ABSORBER

Nitro Gas Strut - Performance			<b>12710GR</b>	2	\$222.00
Foam Cell Strut - Performance			<b>24710FE</b>	2	\$250.00
Foam Cell Pro Strut - Performance			<b>45710FE</b>	2	\$388.00

- Height adjustable with Ironman 4x4 Strut Trim Packers
- Foam Cell Pro, must fit 1198K spacer for Sway Bar clearance

## COIL SPRINGS

	Est. Lift	Additional Load			
Standard	0mm	0 - 50kg	<b>TOY038B</b>	1	\$250.00
Medium	45mm	0 - 50kg	<b>TOY055A</b>	1	\$250.00
Heavy	45mm	50 - 110kg	<b>TOY055B</b>	1	\$250.00

## STRUT MOUNTS

Steel Strut Top			<b>ISST001</b>	2	\$84.00
-----------------	--	--	----------------	---	---------

## TRIM PACKERS

5mm Strut Trim Packer	Nitro Gas / Foam Cell	<b>HILFR05 / HILFR05F</b>	2	\$28.00
10mm Strut Trim Packer	Nitro Gas / Foam Cell	<b>HILFR10 / HILFR10F</b>	2	\$28.00
15mm Strut Trim Packer	Nitro Gas / Foam Cell	<b>HILFR15 / HILFR15F</b>	2	\$28.00

- ONLY Compatible with Ironman 4x4 Struts (except Pro), lift height subject to 2:1 motion ratio. Unnecessary fitment may lift vehicle too high

## CONTROL ARMS

Pro-Forge Upper Control Arms			<b>UCA001FA</b>	1	\$882.00
------------------------------	--	--	-----------------	---	----------

## SPACER KIT

Sway Bar Spacer			<b>1198K</b>	1	\$97.00
-----------------	--	--	--------------	---	---------

## REAR SUSPENSION

## SHOCK ABSORBER

Nitro Gas - Comfort			<b>12743GRC</b>	2	\$153.00
Nitro Gas - Performance			<b>12743GR</b>	2	\$153.00
Foam Cell - Comfort			<b>24743FEC</b>	2	\$222.00
Foam Cell - Performance			<b>24743FE</b>	2	\$222.00
Foam Cell Pro - Comfort			<b>45743FEC</b>	2	\$305.00
Foam Cell Pro - Performance			<b>45743FE</b>	2	\$305.00

## COIL SPRINGS

	Est. Lift	Additional Load			
Standard	0mm	0 - 200kg	<b>TOY017S</b>	1	\$250.00
Light	40mm	0 - 200kg	<b>TOY017A</b>	1	\$250.00
Medium	45mm	0 - 300kg	<b>TOY017B</b>	1	\$250.00

## SPACER KIT

Centre Bearing Spacer Kit			<b>1192K</b>	1	\$28.00
---------------------------	--	--	--------------	---	---------

## SUSPENSION KIT

Standard - Nitro Gas	<b>TOY017SKG</b>	\$1247.00
Standard - Foam Cell	<b>TOY017SKF</b>	\$1981.00
Standard - Foam Cell Pro	<b>TOY017SKP</b>	\$2009.00
Light - Nitro Gas	<b>TOY017AKG</b>	\$1247.00
Light - Foam Cell	<b>TOY017AKF</b>	\$1441.00
Light - Foam Cell Pro	<b>TOY017AKP</b>	\$1981.00
Medium - Nitro Gas	<b>TOY017BKG</b>	\$1247.00
Medium - Foam Cell	<b>TOY017BKF</b>	\$1441.00
Medium - Foam Cell Pro	<b>TOY017BKP</b>	\$1981.00

- Specify front Coil Springs when ordering

## SUSPENSION KIT CONTENTS

Shock Absorbers	Strut Shock Absorbers
Coil Springs	Sway Bar Spacer (Pro Kits Only)



Product Description

Part No.

Qty  
Req

Retail  
ea Inc GST

## SUSPENSION TO SUIT TOYOTA HIACE

### FRONT SUSPENSION

#### SHOCK ABSORBER

Foam Cell Strut - Performance	Left Hand Side		<b>24840FE LH</b>	1	\$278.00
Foam Cell - Performance	Right Hand Side		<b>24840FE RH</b>	1	\$278.00

#### COIL SPRINGS

	Est. Lift	Additional Load			
Medium	40mm	0 - 50kg	<b>TOY072B</b>	1	\$250.00

### REAR SUSPENSION

#### SHOCK ABSORBER

Foam Cell - Comfort			<b>24842FEC</b>	2	\$222.00
Foam Cell - Performance			<b>24842FE</b>	2	\$222.00

#### LEAF SPRINGS

	Est. Lift	Additional Load			
Medium - (Single Stage Parabolic)	45mm	0 - 300kg	<b>TOY073B</b>	2	\$582.00
Heavy - (Dual Stage Parabolic)	45mm	300kg - GVM	<b>TOY073C</b>	2	\$582.00

#### U-BOLTS

U-Bolt Kit			<b>1106UBK</b>	2	\$42.00
------------	--	--	----------------	---	---------

#### POLYURETHANE SPRING BUSHES

Bush Kit			<b>1154UK</b>	1	\$231.00
----------	--	--	---------------	---	----------

### SUSPENSION KIT

Medium - Foam Cell			<b>TOY074BKF</b>		\$2725.00
Heavy - Foam Cell			<b>TOY074CKF</b>		\$2725.00

### SUSPENSION KIT CONTENTS

Shock Absorbers	Coil Springs	U-Bolts
Strut Shock Absorbers	Leaf Springs	Polyurethane Spring Bushes

## Toyota Hiace

Series 200  
2005 to 2019

Product Description

Part No.

Qty  
ReqRetail  
ea Inc GST

## SUSPENSION TO SUIT TOYOTA HIACE

## FRONT SUSPENSION

## SHOCK ABSORBER

Nitro Gas - Performance	12667GR	2	\$153.00
Foam Cell - Performance	24667FE	2	\$222.00

## TORSION BAR

Uprated Torsion Bars	TOY042	1	\$442.00
----------------------	--------	---	----------

• Minimum 60mm downward suspension travel required after adjustment

## REAR SUSPENSION

## SHOCK ABSORBER

Nitro Gas - Comfort	12805GRC	2	\$153.00
Nitro Gas - Performance	12805GR	2	\$153.00
Foam Cell - Performance	24805FE	2	\$222.00

## LEAF SPRINGS

Heavy	Est. Lift	Additional Load	
	40mm	400kg - GVM	

	TOY044C	2	\$513.00
--	---------	---	----------

## U-BOLTS

U-Bolt Kit	415UBK	2	\$42.00
------------	--------	---	---------

## POLYURETHANE SPRING BUSHES

Bush Kit	728UKL	1	\$84.00
----------	--------	---	---------

## HELPER SPRINGS

Load Plus Helper Springs	LP3	1	\$157.00
--------------------------	-----	---	----------

Add-A-Leaf	ISL6010	1	\$167.00
------------	---------	---	----------

## SUSPENSION KIT

Heavy - Nitro Gas	TOY044CKG	\$1995.00
Heavy - Foam Cell	TOY044CKF	\$2161.00

## SUSPENSION KIT CONTENTS

Shock Absorbers	Torsion Bars	Polyurethane Spring Bushes
Leaf Springs	U-Bolts	



Product Description

Part No.

Qty  
Req

Retail  
ea Inc GST

## ACCESSORIES TO SUIT TOYOTA HILUX

### STEEL WINCH BULL BARS

Commercial Deluxe*	BBCD076 *	\$2284.00
Commercial Deluxe†	BBCD076-NB †	\$2284.00
Proguard No Loop*	BBT076-NL *	\$1855.00
Proguard Single Loop Kit*	BB076-SL *	\$336.00
Proguard Triple Loop Kit*	BB076-TL *	\$404.00

\* Suits wide body models only - Hi-Rider - 4x2 SR & SR5 / Dual Cab 4x4 - Workmate, SR & SR5 / Extra Cab 4x4 - Workmate, SR & SR5 - 1860mm Width

† Suits narrow body models only - Single Cab 4x4 Workmate, SR / Dual Cab 4x2 Workmate / Single Cab 4x2 Workmate - 1780mm Width

### STEEL SIDE STEPS AND RAILS

Side Steps - Fits Dual Cab models only	SS051	\$962.00
Side Rails	SS051 RAIL	\$317.00
Side Steps and Rails - Fits Dual Cab models only	SSR051	\$1155.00

### TOWING

Class 4 Towbar - Compatible with Factory Rear Bumper	TB051	\$581.00
Rear Protection Towbar - Full Rear Bumper Replacement* - With Side Tubes	RTB051-SP	\$1328.00
Rear Protection Towbar Plates (Pair)	RTBPLATE001	\$146.00
Towbar Wiring Loom - Plug and Play	ITBL076	\$510.00

### RECOVERY POINTS - IRONMAN 4X4 BULL BAR ONLY

Recovery Points (Pair)	IRP051	\$217.00
------------------------	--------	----------

### LOCKSAFE DRAWER SYSTEMS

Twin Drawers - 1300mm	ITD1300	\$1469.00
Single Drawer - 1300mm	ISD1300	\$891.00
Wing Kit - 1300mm*	ITDW051	\$351.00

\*Designed to suit factory tubs, will not suit ute liner without modification.

### SNORKEL

2.8L Turbo Diesel	ISNORKEL051	\$418.00
Narrow Body Model	ISNORKEL076N	\$418.00

### LONG RANGE FUEL TANK

135L* - 2.8L Diesel 4WD Dual Cab	TANK051	\$1129.00
----------------------------------	---------	-----------

\* Usable volume may differ to the stated tank capacity

### PREMIUM UNDERBODY PROTECTION

Engine Bay and Transmission	UBP051	\$748.00
-----------------------------	--------	----------

### EXHAUST SYSTEM

Engine Bay and Transmission 3" Exhaust Upgrade 2.8L 2016+ - DPF Back - While Stocks Last	IEX051	\$770.00
--	--------	----------

### CANOPY - ABS PLASTIC (SIDE LIFT UP WINDOWS AND CENTRAL LOCKING REAR DOOR) - FITS 4X4 AND 4X2 DUAL CAB MODELS

<b>A DECK</b>		
Pre-Primed - A Deck	CANOPY015-P †	\$3238.00*
Super White (040)	CANOPY015-SW †	\$3856.00
Attitude Black (218) - While Stocks Last	CANOPY015-AB	\$2321.00
Blue Metallic / Nebular Blue (8X2) - While Stocks Last	CANOPY015-BM	\$2321.00
ABS Canopy Rack Feet	IRRFETABS14	\$274.00

\* See Page 37 and 38 for 1.4m Roof Rack options and pricing.

\* Pre-primed canopies, plus colour coding. († With central locking)



## Toyota Hilux

8/2020+

## Product Description

Part No.

Qty  
ReqRetail  
ea Inc GST**CANOPY - PINNACLE SMOOTH FINISH FIBREGLASS (SIDE LIFT UP WINDOWS AND CENTRAL LOCKING REAR DOOR) - FITS 4X4 AND 4X2 DUAL CAB MODELS****A DECK**

Pre-Primed	CANFIBRE051-P	\$2899.00*
Super White (040)	CANFIBRE051-SW	\$3399.00
Silver Metallic / Silver Sky (1D6)	CANFIBRE051-SM	\$3399.00
Attitude Black (218)	CANFIBRE051-AB	\$3399.00
Dark Grey (1G3)	CANFIBRE051-DG	\$3399.00

- Fits A Deck 4x4 and 4x2 Dual Cab models

- \* Pre-primed canopies, plus colour coding.

**CANOPY - PINNACLE 2 SMOOTH FINISH FIBREGLASS (SIDE LIFT UP WINDOWS AND CENTRAL LOCKING REAR DOOR) - FITS 4X4 AND 4X2 DUAL CAB MODELS****A DECK**

Pre-Primed	ICANOPY051-P	\$2899.00*
Super White (040)	ICANOPY051-SW	\$3399.00
Silver Metallic / Silver Sky (1D6)	ICANOPY051-SM	\$3399.00
Attitude Black (218)	ICANOPY051-AB	\$3399.00
Dark Grey (1G3)	ICANOPY051-DG	\$3399.00

**SLIDE-AWAY ROLL UP HARD TONNEAU COVER**

Electric with Remote Control	ISLIDEAWAY051-E	\$2599.00
------------------------------	-----------------	-----------

- Suits J Deck models only

**SEAT COVER**

Canvas Comfort - Front	ICSC051F	\$401.00
Canvas Comfort - Rear	ICSC051R	\$401.00

**DIFF BREATHER KIT**

Diff Breather Kit	IDIFFBRE	\$115.00
-------------------	----------	----------



LISTING  
CONTINUED  
OVER THE  
PAGE



Product Description

Part No.

Qty  
Req

Retail  
ea Inc GST

## SUSPENSION TO SUIT TOYOTA HILUX

### FRONT SUSPENSION

#### SHOCK ABSORBER

Nitro Gas Strut - Performance			<b>12730GR</b>	2	\$222.00
Foam Cell Strut - Performance			<b>24730FE</b>	2	\$250.00
Foam Cell Pro Strut - Performance			<b>45730FE</b>	2	\$388.00

- Height adjustable with Ironman 4x4 Strut Trim Packers
- Operating clearance to sway bar can be increased by installing 1210K offset sway bar bracket

#### COIL SPRINGS

	Est. Lift	Additional Load			
Standard	0mm	0 - 50kg	<b>TOY055A</b>	1	\$250.00
Light	20mm	0 - 50kg	<b>TOY055B</b>	1	\$250.00
Light	45mm	0 - 50kg	<b>TOY065A</b>	1	\$250.00
Medium	30mm	0 - 50kg	<b>TOY055C</b>	1	\$250.00
Medium - with Accessories	45mm	0 - 50kg	<b>TOY065B</b>	1	\$250.00
Heavy	45mm	50 - 110kg	<b>TOY065C</b>	1	\$250.00

#### STRUT MOUNTS

Steel Strut Top			<b>ISST001</b>	2	\$84.00
-----------------	--	--	----------------	---	---------

#### TRIM PACKERS

5mm Strut Trim Packer	Nitro Gas / Foam Cell	<b>HILFR05 / HILFR05F</b>	2	\$28.00
10mm Strut Trim Packer	Nitro Gas / Foam Cell	<b>HILFR10 / HILFR10F</b>	2	\$28.00
15mm Strut Trim Packer	Nitro Gas / Foam Cell	<b>HILFR15 / HILFR15F</b>	2	\$28.00

- ONLY Compatible with Ironman 4x4 Struts (except Pro), lift height subject to 2:1 motion ratio. Unnecessary fitment may lift vehicle too high

#### CONTROL ARMS

Pro-Forge Upper Control Arms			<b>UCA001FA</b>	1	\$882.00
------------------------------	--	--	-----------------	---	----------

#### SWAY BAR

33mm Sway Bar			<b>ISB80F</b>	1	\$582.00
Offset Sway Bar Bracket			<b>1210K</b>	1	\$139.00

### REAR SUSPENSION

#### SHOCK ABSORBER

Nitro Gas - Comfort			<b>12081GRC</b>	2	\$153.00
Nitro Gas - Performance			<b>12081GR</b>	2	\$153.00
Foam Cell - Comfort			<b>24081FEC</b>	2	\$222.00
Foam Cell - Performance			<b>24081FE</b>	2	\$222.00
Foam Cell - Professional			<b>24081FEP</b>	2	\$222.00
Foam Cell Pro - Comfort			<b>45081FEC</b>	2	\$305.00
Foam Cell Pro - Performance			<b>45081FE</b>	2	\$305.00
Foam Cell Pro - Professional			<b>45081FEP</b>	2	\$305.00

#### LEAF SPRINGS

	Est. Lift	Additional Load			
Light	40mm	0 - 100kg	<b>TOY077A</b>	2	\$375.00
Medium	45mm	0 - 200kg	<b>TOY077B</b>	2	\$375.00
Heavy	45mm	200 - 400kg	<b>TOY077C</b>	2	\$402.00
Extra Heavy	45mm	400kg - GVM	<b>TOY077D</b>	2	\$402.00

- New spring pins 387-1 may be required, as OEM orientation may require cutting for removal

#### U-BOLTS

U-Bolt Kit			<b>437UBKL</b>	2	\$42.00
------------	--	--	----------------	---	---------

#### POLYURETHANE SPRING BUSHES

Bush Kit			<b>767UK</b>	1	\$84.00
----------	--	--	--------------	---	---------

#### SPACER KIT

Centre Bearing Spacer Kit			<b>1192K</b>	1	\$28.00
Headlight Adjustment Leaf Spring Bracket (SR5 Only)			<b>1213K</b>	1	\$18.00

#### GREASABLE SHACKLES AND PINS

Greasable Shackle			<b>1155</b>	2	\$56.00
Non-Greasable Pin			<b>387-1</b>	2	\$28.00

#### HELPER SPRINGS

Load Plus Helper Springs			<b>LP2</b>	1	\$157.00
Add-A-Leaf			<b>ISL6010</b>	1	\$167.00





8/2020+

# Toyota Hilux

Product Description

Part No.

Qty  
Req

Retail  
ea Inc GST

### SUSPENSION KIT

Light - Nitro Gas	TOY077AKG	\$1967.00
Light - Foam Cell	TOY077AKF	\$2161.00
Light - Foam Cell Pro	TOY077AKP	\$2743.00
Medium - Nitro Gas	TOY077BKG	\$1967.00
Medium - Foam Cell	TOY077BKF	\$2161.00
Medium - Foam Cell Pro	TOY077BKP	\$2743.00
Heavy - Nitro Gas	TOY077CKG	\$2023.00
Heavy - Foam Cell	TOY077CKF	\$2217.00
Heavy - Foam Cell Pro	TOY077CKP	\$2799.00
Extra Heavy - Nitro Gas	TOY077DKG	\$2023.00
Extra Heavy - Foam Cell	TOY077DKF	\$2217.00
Extra Heavy - Foam Cell Pro	TOY077DKP	\$2799.00

• Specify Front Coil Springs when ordering

### SUSPENSION KIT CONTENTS

Shock Absorbers	Coil Springs	U-Bolts	Non-Greasable Pins
Strut Shock Absorbers	Leaf Springs	Polyurethane Spring Bushes	Offset Sway Bar Bracket (Pro Kits Only)



OPTIONS AVAILABLE FOR THIS VEHICLE - SEE PAGE 385



Product Description

Part No.

Qty  
Req

Retail  
ea Inc GST

## ACCESSORIES TO SUIT TOYOTA HILUX

### STEEL WINCH BULL BARS SUITS

Commercial - (2015 to 4/2018 Only) *	BBC051 *	\$1678.00
Commercial - (5/2018 to 7/2020 Only) *	BBC065 *	\$1678.00
Commercial - (Narrow Body Only) †	BBC065-NB †	\$1648.00
Commercial Deluxe - (2015 to 4/2018 Only) *	BBCD051 *	\$2284.00
Commercial Deluxe - (5/2018 to 7/2020 Only) *	BBCD065 *	\$2284.00
Polished Alloy - (2015 to 4/2018 Only) *	BBA051 *	\$2845.00
Polished Alloy - (5/2018 to 7/2020 Only) *	BBA065 *	\$2845.00
Proguard No Loop - (2015 to 4/2018 Only) *	BBT051-NL *	\$1888.00
Proguard No Loop - (5/2018 to 7/2020 Only) *	BBT065-NL *	\$1888.00
Proguard Single Loop Kit - (2015 to 4/2018 Only) *	BB051-SL *	\$336.00
Proguard Single Loop Kit - (5/2018 to 7/2020 Only) *	BB065-SL *	\$336.00
Proguard Triple Loop Kit - (2015 to 4/2018 Only) *	BB051-TL *	\$404.00
Proguard Triple Loop Kit - (5/2018 to 7/2020 Only) *	BB065-TL *	\$404.00

\* Winch with Steel Cable and Roller Fairlead is not suitable - Use Winch with Synthetic Rope and Alloy Hawse only

\* Suits wide body models only - Hi-Rider - 4x2 SR & SR5 / Dual Cab 4x4 - Workmate, SR & SR5 / Extra Cab 4x4 - Workmate, SR & SR5

† Suits narrow body models only - Single Cab 4x4 Workmate, SR / Dual Cab 4x2 Workmate / Single Cab 4x2 Workmate

### STEEL SIDE STEPS AND RAILS

Side Steps - Fits Dual Cab models only	SS051	\$962.00
Side Rails	SS051 RAIL	\$317.00
Side Steps and Rails - Fits Dual Cab models only	SSR051	\$1155.00

### TOWING

Class 4 Towbar - Compatible with Factory Rear Bumper	TB051	\$581.00
Rear Protection Towbar - Full Rear Bumper Replacement* - With Side Tubes	RTB051-P	\$1328.00
Rear Protection Towbar Plates (Pair)	RTBPLATE001	\$146.00
Towbar Wiring Loom - Plug and Play	ITBL051	\$276.00

### RECOVERY POINTS - IRONMAN 4X4 BULL BAR ONLY

Recovery Points - 5000kg Rating (Pair)	IRP051	\$217.00
--	--------	----------

### LOCKSAFE DRAWER SYSTEMS

Twin Drawers - 1300mm	ITD1300	\$1469.00
Single Drawer - 1300mm	ISD1300	\$891.00
Wing Kit - 1300mm*	ITDW051	\$351.00

\* Designed to suit factory tubs, will not suit ute liner without modification.

### SNORKEL

2.8L Turbo Diesel	ISNORKEL051	\$418.00
-------------------	-------------	----------

### LONG RANGE FUEL TANK

135L* - 2.8L Diesel 4WD	TANK051	\$1129.00
-------------------------	---------	-----------

\* Usable volume may differ to the stated tank capacity

### PREMIUM UNDERBODY PROTECTION

Engine Bay and Transmission	UBP051	\$748.00
-----------------------------	--------	----------

### EXHAUST SYSTEM

3" Exhaust Upgrade 2.8L 2016+ - DPF Back - While Stocks Last	IEX051	\$770.00
--	--------	----------



Revo  
2015 to 4/2018  
(Facelift) 5/2018 to 7/2020

# Toyota Hilux

**Product Description**

**Part No.**

**Qty  
Req**

**Retail  
ea Inc GST**

**CANOPY - ABS PLASTIC (SIDE LIFT UP WINDOWS AND CENTRAL LOCKING REAR DOOR) - FITS 4X4 AND 4X2 DUAL CAB MODELS**

**A DECK**

Pre-Primed - A Deck	CANOPY015-P †	\$3238.00*
Super White (040)	CANOPY015-SW †	\$3856.00
Attitude Black (218) - <i>While Stocks Last</i>	CANOPY015-AB	\$2321.00
Blue Metallic / Nebular Blue (8X2) - <i>While Stocks Last</i>	CANOPY015-BM	\$2321.00
ABS Canopy Rack Feet	IRRFEEABS14	\$274.00

• See Page 37 and 38 for 1.4m Roof Rack options and pricing.  
\* Pre-primed canopies, plus colour coding. († With central locking)

**J DECK**

Super White (040)	CANOPY017-SW	\$3856.00
-------------------	--------------	-----------

**CANOPY - PINNACLE SMOOTH FINISH FIBREGLASS (SIDE LIFT UP WINDOWS AND CENTRAL LOCKING REAR DOOR) - FITS 4X4 AND 4X2 DUAL CAB MODELS**

**A DECK**

Pre-Primed	CANFIBRE051-P	\$2899.00*
Super White (040)	CANFIBRE051-SW	\$3399.00
Silver Metallic / Silver Sky (1D6)	CANFIBRE051-SM	\$3399.00
Attitude Black (218)	CANFIBRE051-AB	\$3399.00
Dark Grey (1G3)	CANFIBRE051-DG	\$3399.00

• Fits A Deck 4x4 and 4x2 Dual Cab models  
\* Pre-primed canopies, plus colour coding.

**CANOPY - PINNACLE 2 SMOOTH FINISH FIBREGLASS (SIDE LIFT UP WINDOWS AND CENTRAL LOCKING REAR DOOR) - FITS 4X4 AND 4X2 DUAL CAB MODELS**

**A DECK**

Pre-Primed	ICANOPY051-P	\$2899.00*
Super White (040)	ICANOPY051-SW	\$3399.00
Silver Metallic / Silver Sky (1D6)	ICANOPY051-SM	\$3399.00
Attitude Black (218)	ICANOPY051-AB	\$3399.00
Dark Grey (1G3)	ICANOPY051-DG	\$3399.00

**SLIDE-AWAY ROLL UP HARD TONNEAU COVER**

Electric with Remote Control	ISLIDEAWAY051-E	\$2599.00
------------------------------	-----------------	-----------

• Suits J Deck models only

**SEAT COVER**

Canvas Comfort - Front	ICSC051F	\$401.00
Canvas Comfort - Rear	ICSC051R	\$401.00

**DIFF BREATHER KIT**

Diff Breather Kit	IDIFFBRE	\$115.00
-------------------	----------	----------







## Product Description

## Part No.

Qty  
ReqRetail  
ea Inc GST

## SUSPENSION TO SUIT TOYOTA HILUX

## FRONT SUSPENSION

## SHOCK ABSORBER

Nitro Gas Strut - Performance			12730GR	2	\$222.00
Foam Cell Strut - Performance			24730FE	2	\$250.00
Foam Cell Pro Strut - Performance			45730FE	2	\$388.00

• Height adjustable with Ironman 4x4 Strut Trim Packers

• Operating clearance to sway bar can be increased by installing 1210K offset sway bar bracket

## COIL SPRINGS

	Est. Lift	Additional Load			
Standard	0mm	0 - 50kg	TOY055A	1	\$250.00
Light	20mm	0 - 50kg	TOY055B	1	\$250.00
Light	45mm	0 - 50kg	TOY065A	1	\$250.00
Medium	30mm	0 - 50kg	TOY055C	1	\$250.00
Medium - with Accessories	45mm	0 - 50kg	TOY065B	1	\$250.00
Heavy	45mm	50 - 110kg	TOY065C	1	\$250.00

## STRUT MOUNTS

Steel Strut Top			ISST001	2	\$84.00
-----------------	--	--	---------	---	---------

## TRIM PACKERS

5mm Strut Trim Packer	Nitro Gas / Foam Cell	HILFR05 / HILFR05F	2	\$28.00
10mm Strut Trim Packer	Nitro Gas / Foam Cell	HILFR10 / HILFR10F	2	\$28.00
15mm Strut Trim Packer	Nitro Gas / Foam Cell	HILFR15 / HILFR15F	2	\$28.00

• ONLY Compatible with Ironman 4x4 Struts (except Pro), lift height subject to 2:1 motion ratio. Unnecessary fitment may lift vehicle too high

## CONTROL ARMS

Pro-Forge Upper Control Arms			UCA001FA	1	\$882.00
------------------------------	--	--	----------	---	----------

## SWAY BAR

33mm Sway Bar			ISB80F	1	\$582.00
Offset Sway Bar Bracket			1210K	1	\$139.00

## REAR SUSPENSION

## SHOCK ABSORBER

Nitro Gas - Comfort			12081GRC	2	\$153.00
Nitro Gas - Performance			12081GR	2	\$153.00
Foam Cell - Comfort			24081FEC	2	\$222.00
Foam Cell - Performance			24081FE	2	\$222.00
Foam Cell - Professional			24081FEP	2	\$222.00
Foam Cell Pro - Comfort			45081FEC	2	\$305.00
Foam Cell Pro - Performance			45081FE	2	\$305.00
Foam Cell Pro - Professional			45081FEP	2	\$305.00

## LEAF SPRINGS

	Est. Lift	Additional Load			
Light	40mm	0 - 100kg	TOY077A	2	\$375.00
Medium	45mm	0 - 200kg	TOY077B	2	\$375.00
Heavy	45mm	200 - 400kg	TOY077C	2	\$402.00
Extra Heavy	45mm	400kg - GVM	TOY077D	2	\$402.00

• New spring pins 387-1 may be required, as OEM orientation may require cutting for removal

## U-BOLTS

U-Bolt Kit			437UBKL	2	\$42.00
------------	--	--	---------	---	---------

## POLYURETHANE SPRING BUSHES

Bush Kit			767UK	1	\$84.00
----------	--	--	-------	---	---------

## SPACER KIT

Centre Bearing Spacer Kit			1192K	1	\$28.00
Headlight Adjustment Leaf Spring Bracket (SR5 Only)			1213K	1	\$18.00

## GREASABLE SHACKLES AND PINS

Greasable Shackle			1155	2	\$56.00
Non-Greasable Pin			387-1	2	\$28.00

## HELPER SPRINGS

Load Plus Helper Springs			LP2	1	\$157.00
Add-A-Leaf			ISL6010	1	\$167.00



Revo  
2015 to 4/2018  
(Facelift) 5/2018 to 7/2020

**SUSPENSION TO SUIT**

# Toyota Hilux

Product Description

Part No.

Qty  
Req

Retail  
ea Inc GST

## SUSPENSION KIT

Light - Nitro Gas	TOY077AKG	\$1967.00
Light - Foam Cell	TOY077AKF	\$2161.00
Light - Foam Cell Pro	TOY077AKP	\$2743.00
Medium - Nitro Gas	TOY077BKG	\$1967.00
Medium - Foam Cell	TOY077BKF	\$2161.00
Medium - Foam Cell Pro	TOY077BKP	\$2743.00
Heavy - Nitro Gas	TOY077CKG	\$2023.00
Heavy - Foam Cell	TOY077CKF	\$2217.00
Heavy - Foam Cell Pro	TOY077CKP	\$2799.00
Extra Heavy - Nitro Gas	TOY077DKG	\$2023.00
Extra Heavy - Foam Cell	TOY077DKF	\$2217.00
Extra Heavy - Foam Cell Pro	TOY077DKP	\$2799.00

• Specify Front Coil Springs when ordering

## SUSPENSION KIT CONTENTS

Shock Absorbers	Coil Springs	U-Bolts	Non-Greasable Pins
Strut Shock Absorbers	Leaf Springs	Polyurethane Spring Bushes	Offset Sway Bar Bracket (Pro Kits Only)



**OPTIONS AVAILABLE FOR THIS VEHICLE - SEE PAGE 385**



Product Description

Part No.

Qty  
ReqRetail  
ea Inc GST

## ACCESSORIES TO SUIT TOYOTA HILUX

**STEEL WINCH BULL BARS**

Commercial - (3/2005 to 9/2011 Only)	<b>BBC002</b>	\$1648.00
Commercial - (10/2011 to 2015 Only)	<b>BBC033</b>	\$1648.00
Commercial Deluxe - (3/2005 to 9/2011 Only)	<b>BBCD002</b>	\$2244.00
Commercial Deluxe - (10/2011 to 2015 Only)	<b>BBCD033</b>	\$2244.00
Protector - (10/2011 to 2015 Only) - <i>While Stocks Last</i>	<b>BBT033</b>	\$2271.00

**STEEL SIDE STEPS AND RAILS**

Side Steps - Fits Dual Cab models only	<b>SS033</b>	\$962.00
Side Steps and Rails - Fits Dual Cab models only	<b>SSR033</b>	\$1155.00

**RECOVERY POINTS - IRONMAN 4X4 BULL BAR ONLY**

Recovery Points - 5000kg Rating (Pair)	<b>IRP033</b>	\$217.00
--	---------------	----------

**LOCKSAFE DRAWER SYSTEMS**

Twin Drawers - 1300mm	<b>ITD1300</b>	\$1469.00
Single Drawer - 1300mm	<b>ISD1300</b>	\$891.00
Wing Kit - 1300mm*	<b>ITDW024</b>	\$351.00

\*Designed to suit factory tubs, will not suit ute liner without modification.

**SNORKEL**

3L D4D TDi / 4L Petrol V6	<b>ISNORKEL001</b>	\$418.00
---------------------------	--------------------	----------

**LONG RANGE FUEL TANK**

145L* - Diesel and Petrol 4WD only	<b>TANK002</b>	\$1129.00
------------------------------------	----------------	-----------

\*Usable volume may differ to the stated tank capacity

**PREMIUM UNDERBODY PROTECTION**

Engine Bay and Transmission	<b>UBP033</b>	\$748.00
-----------------------------	---------------	----------

**UNDERBODY PROTECTION**

Engine Bay and Transmission - <i>While Stocks Last</i>	<b>IUP001K</b>	\$563.00
--	----------------	----------

**CANOPY - ABS PLASTIC (SIDE LIFT UP WINDOWS) - FITS 4X4 AND 4X2 DUAL CAB MODELS**

<b>J DECK</b>		
Pre-Primed - J Deck - <i>While Stocks Last</i>	<b>CANOPY002-P</b>	\$3238.00*
Round Profile - J Deck - <i>While Stocks Last</i>	<b>CANOPY002A</b>	\$3856.00

\*Pre-primed canopies, plus colour coding.

**SEAT COVER**

Canvas Comfort - Front	<b>ICSC033F</b>	\$401.00
Canvas Comfort - Rear	<b>ICSC033R</b>	\$401.00

**DIFF BREATHER KIT**

Diff Breather Kit	<b>IDIFFBRE</b>	\$115.00
-------------------	-----------------	----------





Vigo  
3/2005 to 9/2011  
(Facelift) 10/2011 to 2015

**Product Description**

**Part No.**

**Qty  
Req**

**Retail  
ea Inc GST**

**SUSPENSION TO SUIT TOYOTA HILUX**

**FRONT SUSPENSION**

**SHOCK ABSORBER**

Nitro Gas Strut - Performance			<b>12710GR</b>	2	\$222.00
Foam Cell Strut - Performance			<b>24710FE</b>	2	\$250.00
Foam Cell Pro Strut - Performance			<b>45710FE</b>	2	\$388.00
<ul style="list-style-type: none"> <li>• Height adjustable with Ironman 4x4 Strut Trim Packers</li> <li>• Foam Cell Pro, must fit 1198K spacer for Sway Bar clearance</li> </ul>					

**COIL SPRINGS**

	Est. Lift	Additional Load			
Light	40mm	0 - 50kg	<b>TOY055A</b>	1	\$250.00
Medium	45mm	0 - 50kg	<b>TOY055B</b>	1	\$250.00
Heavy	45mm	50 - 110kg	<b>TOY055C</b>	1	\$250.00

**STRUT MOUNTS**

Steel Strut Top			<b>ISST001</b>	2	\$84.00
-----------------	--	--	----------------	---	---------

**TRIM PACKERS**

5mm Strut Trim Packer	Nitro Gas / Foam Cell	<b>HILFR05 / HILFR05F</b>	2	\$28.00	
10mm Strut Trim Packer	Nitro Gas / Foam Cell	<b>HILFR10 / HILFR10F</b>	2	\$28.00	
15mm Strut Trim Packer	Nitro Gas / Foam Cell	<b>HILFR15 / HILFR15F</b>	2	\$28.00	
<ul style="list-style-type: none"> <li>• ONLY Compatible with Ironman 4x4 Struts (except Pro), lift height subject to 2:1 motion ratio. Unnecessary fitment may lift vehicle too high</li> </ul>					

**CONTROL ARMS**

Pro-Forge Upper Control Arms			<b>UCA001FA</b>	1	\$882.00
------------------------------	--	--	-----------------	---	----------

**SPACER KIT**

Sway Bar Spacer			<b>1198K</b>	1	\$97.00
-----------------	--	--	--------------	---	---------

**REAR SUSPENSION**

**SHOCK ABSORBER**

Nitro Gas - Comfort			<b>12650GRC</b>	2	\$153.00
Nitro Gas - Performance			<b>12650GR</b>	2	\$153.00
Nitro Gas Extra Long - Comfort			<b>12081GRC</b>	2	\$153.00
Nitro Gas Extra Long - Performance			<b>12081GR</b>	2	\$153.00
Foam Cell - Comfort			<b>24650FEC</b>	2	\$222.00
Foam Cell - Performance			<b>24650FE</b>	2	\$222.00
Foam Cell Extra Long - Comfort			<b>24081FEC</b>	2	\$222.00
Foam Cell Extra Long - Performance			<b>24081FE</b>	2	\$222.00
Foam Cell Extra Long - Professional			<b>24081FEP</b>	2	\$222.00
Foam Cell Pro - Comfort			<b>45650FEC</b>	2	\$305.00
Foam Cell Pro - Performance			<b>45650FE</b>	2	\$305.00
Foam Cell Pro Extra Long - Comfort			<b>45081FEC</b>	2	\$305.00
Foam Cell Pro Extra Long - Performance			<b>45081FE</b>	2	\$305.00
Foam Cell Pro Extra Long - Professional			<b>45081FEP</b>	2	\$305.00

**LEAF SPRINGS**

	Est. Lift	Additional Load			
Light	45mm	0 -100kg	<b>TOY057A</b>	2	\$375.00
Medium	45mm	0 -200kg	<b>TOY057B</b>	2	\$375.00
Heavy	45mm	200 - 400kg	<b>TOY057C</b>	2	\$402.00
Extra Heavy	45mm	400kg - GVM	<b>TOY057D</b>	2	\$402.00

**U-BOLTS**

U-Bolt Kit			<b>437UBK</b>	2	\$42.00
U-Bolt Kit Extra long	Suits TOY057A and TOY057D Spring		<b>437UBKL</b>	2	\$42.00

**POLYURETHANE SPRING BUSHES**

Bush Kit			<b>767UK</b>	1	\$84.00
----------	--	--	--------------	---	---------

**GREASABLE SHACKLES AND PINS**

Greasable Shackle			<b>386-3</b>	2	\$56.00
Non-Greasable Pin			<b>387-1</b>	2	\$28.00

**HELPER SPRINGS**

Load Plus Helper Springs			<b>LP2</b>	1	\$157.00
Add-A-Leaf			<b>ISL6010</b>	1	\$167.00

LISTING  
CONTINUED  
OVER THE  
PAGE



# Toyota Hilux

Vigo  
3/2005 to 9/2011  
(Facelift) 10/2011 to 2015



Product Description

Part No.

Qty  
Req

Retail  
ea Inc GST

## SUSPENSION KIT

Light - Nitro Gas	TOY057AKG	\$1912.00
Light - Foam Cell	TOY057AKF	\$2106.00
Light - Foam Cell Pro	TOY057AKP	\$2646.00
Medium - Nitro Gas	TOY057BKG	\$1912.00
Medium - Foam Cell	TOY057BKF	\$2106.00
Medium - Foam Cell Pro	TOY057BKP	\$2646.00
Heavy - Nitro Gas	TOY057CKG	\$1967.00
Heavy - Foam Cell	TOY057CKF	\$2161.00
Heavy - Foam Cell Pro	TOY057CKP	\$2702.00
Extra Heavy - Nitro Gas	TOY057DKG	\$1967.00
Extra Heavy - Foam Cell	TOY057DKF	\$2161.00
Extra Heavy - Foam Cell Pro	TOY057DKP	\$2702.00

• Specify Front Coil Springs when ordering

## SUSPENSION KIT CONTENTS

Shock Absorbers	Coil Springs	U-Bolts
Strut Shock Absorbers	Leaf Springs	Polyurethane Spring Bushes



**OPTIONS AVAILABLE FOR THIS VEHICLE - SEE PAGE 386**



## Toyota Hilux



Low Ride 2WD  
2005+

Product Description

Part No.

Qty  
ReqRetail  
ea Inc GST

## SUSPENSION TO SUIT TOYOTA HILUX

## FRONT SUSPENSION

## SHOCK ABSORBER

Nitro Gas Strut - Performance	Left Hand Side	<b>12764GR LH</b>	1	\$222.00
Nitro Gas Strut - Performance	Right Hand Side	<b>12764GR RH</b>	1	\$222.00

• Height adjustable with Ironman 4x4 Strut Trim Packers.

## COIL SPRINGS

	Est. Lift	Additional Load		
Medium	40mm	0 -50kg	<b>TOY067B</b>	1

## TRIM PACKERS

5mm Strut Trim Packer	Nitro Gas	<b>HILFR05</b>	2	\$28.00
10mm Strut Trim Packer	Nitro Gas	<b>HILFR10</b>	2	\$28.00
15mm Strut Trim Packer	Nitro Gas	<b>HILFR15</b>	2	\$28.00

• Only compatible with Ironman 4x4 Struts, lift height subject to 2:1 motion ratio. Unnecessary fitment may lift vehicle too high

## REAR SUSPENSION

## SHOCK ABSORBER

Nitro Gas - Comfort		<b>12650GRC</b>	2	\$153.00
Nitro Gas - Performance		<b>12650GR</b>	2	\$153.00
Foam Cell - Comfort		<b>24650FEC</b>	2	\$222.00
Foam Cell - Performance		<b>24650FE</b>	2	\$222.00
Foam Cell - Professional		<b>24650FEP</b>	2	\$222.00

## LEAF SPRINGS

	Est. Lift	Additional Load		
Medium	45mm	0 -200kg	<b>TOY068B</b>	2
Heavy	45mm	200 - 400kg	<b>TOY068C</b>	2

## U-BOLTS

U-Bolt Kit		<b>415UBK</b>	2	\$42.00
------------	--	---------------	---	---------

## POLYURETHANE SPRING BUSHES

Bush Kit	(14mm Front Bolt)	<b>767UK</b>	1	\$84.00
Bush Kit	(23mm Front Pin with Side Plate)	<b>1151UK</b>	1	\$84.00

## GREASABLE SHACKLES AND PINS

Greasable Shackle		<b>386-3</b>	2	\$56.00
Non-Greasable Pin		<b>387-1</b>	2	\$28.00

• 14mm Pin

## HELPER SPRINGS

Load Plus Helper Springs		<b>LP2</b>	1	\$157.00
Add-A-Leaf		<b>ISL6010</b>	1	\$167.00

## SUSPENSION KIT

Medium - Nitro Gas		<b>TOY068BKG</b>		\$1912.00
Heavy - Nitro Gas		<b>TOY068CKG</b>		\$1967.00

• Specify Leaf Springs front bush I/D before ordering

## SUSPENSION KIT CONTENTS

Shock Absorbers  
Leaf Springs

Torsion Bars  
U-Bolts

Polyurethane Spring Bushes

# Toyota Hilux

Tiger  
1997 to 2004



Product Description

Part No.

Qty  
Req

Retail  
ea Inc GST

## ACCESSORIES TO SUIT TOYOTA HILUX

### STEEL WINCH BULL BARS

Commercial Deluxe - (2001 to 2004 Only)

**BBCD001**

\$2244.00

### LOCKSAFE DRAWER SYSTEMS

Twin Drawers - 1300mm

**ITD1300**

\$1469.00

Single Drawer - 1300mm

**ISD1300**

\$891.00

Wing Kit - 1300mm (SR-SR5)\*

**ITDW023**

\$351.00

*\*Designed to suit factory tubs, will not suit ute liner without modification.*

### DIFF BREATHER KIT

Diff Breather Kit

**IDIFFBRE**

\$115.00

# Toyota Hilux



Tiger 107, 108, 110, 111, 167  
1997 to 2005

Product Description

Part No.

Qty  
Req

Retail  
ea Inc GST

## SUSPENSION TO SUIT TOYOTA HILUX

### FRONT SUSPENSION

#### SHOCK ABSORBER

Nitro Gas - Performance	<b>12088GR</b>	2	\$153.00
Foam Cell - Performance	<b>24088FE</b>	2	\$222.00

#### TORSION BAR

Uprated Torsion Bars	<b>TOY026</b>	1	\$416.00
----------------------	---------------	---	----------

• Minimum 60mm downward suspension travel required after adjustment

#### STEERING DAMPER

Foam Cell	<b>3533</b>	1	\$167.00
-----------	-------------	---	----------

• Check clearance to engine sump when fitting steering damper

### REAR SUSPENSION

#### SHOCK ABSORBER

Nitro Gas - Comfort	<b>12081GRC</b>	2	\$153.00
Nitro Gas - Performance	<b>12081GR</b>	2	\$153.00
Foam Cell - Comfort	<b>24081FEC</b>	2	\$222.00
Foam Cell - Performance	<b>24081FE</b>	2	\$222.00
Foam Cell - Professional	<b>24081FEP</b>	2	\$222.00

#### LEAF SPRINGS

	Est. Lift	Additional Load			
Light	40mm	0 -100kg	<b>TOY027A</b>	2	\$375.00
Medium	40mm	0 -200kg	<b>TOY027B</b>	2	\$375.00
Heavy	40mm	200kg - GVM	<b>TOY027C</b>	2	\$402.00

• 1300mm Leaf Length

#### U-BOLTS

U-Bolt Kit		<b>437UBK</b>	2	\$42.00
U-Bolt Kit Extra long	Suits TOY027A Spring	<b>437UBKL</b>	2	\$42.00

#### POLYURETHANE SPRING BUSHES

Bush Kit		<b>758UK</b>	1	\$84.00
----------	--	--------------	---	---------

#### GREASABLE SHACKLES AND PINS

Greasable Shackle	Stepped Shackle	<b>386-1</b>	2	\$56.00
Non-Greasable Pin		<b>387-1</b>	2	\$28.00

#### HELPER SPRINGS

Load Plus Helper Springs		<b>LP2</b>	1	\$157.00
Add-A-Leaf		<b>ISL6010</b>	1	\$167.00

### SUSPENSION KIT

Light - Nitro Gas	<b>TOY027AKG</b>	\$1940.00
Light - Foam Cell	<b>TOY027AKF</b>	\$2217.00
Medium - Nitro Gas	<b>TOY027BKG</b>	\$1940.00
Medium - Foam Cell	<b>TOY027BKF</b>	\$2217.00
Heavy - Nitro Gas	<b>TOY027CKG</b>	\$1995.00
Heavy - Foam Cell	<b>TOY027CKF</b>	\$2272.00

### SUSPENSION KIT CONTENTS

Shock Absorbers	Torsion Bars	Polyurethane Spring Bushes
Leaf Springs	U-Bolts	





Product Description

Part No.

Qty  
Req

Retail  
ea Inc GST

## SUSPENSION TO SUIT TOYOTA HILUX

### FRONT SUSPENSION

#### SHOCK ABSORBER

Nitro Gas - Comfort			<b>12639GRC</b>	2	\$153.00
Nitro Gas - Performance			<b>12639GR</b>	2	\$153.00
Foam Cell - Performance			<b>24639FE</b>	2	\$222.00

#### LEAF SPRINGS

	Est. Lift	Additional Load			
Medium - Drivers Side (Petrol)	50mm	0 - 50kg	<b>TOY010BD/S</b>	1	\$208.00
Medium - Near Side (Petrol)	50mm	0 - 50kg	<b>TOY010BN/S</b>	1	\$208.00
Heavy - Drivers Side (Diesel)	50mm	0 - 100kg	<b>TOY010CD/S</b>	1	\$208.00
Heavy - Near Side (Diesel)	50mm	0 - 100kg	<b>TOY010CN/S</b>	1	\$208.00

• Check clearance to drag link / u-bolt, ADL106 may be required

#### STEERING DAMPER

Foam Cell			<b>3521</b>	1	\$167.00
-----------	--	--	-------------	---	----------

#### U-BOLTS

Drivers Side U-Bolt Kit			<b>678UBK</b>	1	\$42.00
Near Side U-Bolt Kit			<b>437UBK</b>	1	\$42.00

#### POLYURETHANE SPRING BUSHES

Bush Kit			<b>732UK</b>	1	\$70.00
----------	--	--	--------------	---	---------

#### STEERING ARMS

Drop Drag Link			<b>ADL106</b>	1	\$278.00
----------------	--	--	---------------	---	----------

#### GREASABLE SHACKLES AND PINS

Greasable Shackle			<b>384</b>	2	\$70.00
Greasable Pin			<b>385</b>	2	\$42.00

### REAR SUSPENSION

#### SHOCK ABSORBER

Nitro Gas - Comfort			<b>12650GRC</b>	2	\$153.00
Nitro Gas - Performance			<b>12650GR</b>	2	\$153.00
Foam Cell - Comfort			<b>24650FEC</b>	2	\$222.00
Foam Cell - Performance			<b>24650FE</b>	2	\$222.00
Foam Cell - Professional			<b>24650FEP</b>	2	\$222.00

#### LEAF SPRINGS

	Est. Lift	Additional Load			
Medium	50mm	0 - 300kg	<b>TOY011B</b>	2	\$375.00
Heavy	50mm	300kg - GVM	<b>TOY011C</b>	2	\$402.00

#### U-BOLTS

U-Bolt Kit			<b>437UBK</b>	2	\$42.00
------------	--	--	---------------	---	---------

#### POLYURETHANE SPRING BUSHES

Bush Kit			<b>733UK</b>	1	\$70.00
----------	--	--	--------------	---	---------

#### GREASABLE SHACKLES AND PINS

Greasable Shackle			<b>386</b>	2	\$56.00
Greasable Shackle		Extended 5mm	<b>386-2</b>	2	\$56.00
Greasable Pin			<b>385</b>	2	\$42.00

#### HELPER SPRINGS

Load Plus Helper Springs			<b>LP2</b>	1	\$157.00
Add-A-Leaf			<b>ISL6010</b>	1	\$167.00

### SUSPENSION KIT

Medium - Nitro Gas	<b>TOY010BK2</b>	\$2078.00
Medium - Foam Cell	<b>TOY010BK2</b>	\$2355.00
Heavy - Nitro Gas	<b>TOY010CK2</b>	\$2134.00
Heavy - Foam Cell	<b>TOY010CK2</b>	\$2411.00

• Specify front Leaf Springs when ordering

### SUSPENSION KIT CONTENTS

Shock Absorbers	U-Bolts
Leaf Springs	Polyurethane Spring Bushes

## Toyota Hilux



Solid Front Axle  
1979 to 10/1983

Product Description

Part No.

Qty  
ReqRetail  
ea Inc GST

## SUSPENSION TO SUIT TOYOTA HILUX

## FRONT SUSPENSION

## SHOCK ABSORBER

Nitro Gas - Comfort			<b>12639GRC</b>	2	\$153.00
Nitro Gas - Performance			<b>12639GR</b>	2	\$153.00
Foam Cell - Performance			<b>24639FE</b>	2	\$222.00

## LEAF SPRINGS

	Est. Lift	Additional Load			
Medium - Drivers Side (Petrol)	50mm	0 - 50kg	<b>TOY010BD/S</b>	1	\$208.00
Medium - Near Side (Petrol)	50mm	0 - 50kg	<b>TOY010BN/S</b>	1	\$208.00
Heavy - Drivers Side (Diesel)	50mm	0 - 100kg	<b>TOY010CD/S</b>	1	\$208.00
Heavy - Near Side (Diesel)	50mm	0 - 100kg	<b>TOY010CN/S</b>	1	\$208.00

• Check clearance to drag link / u-bolt, ADL106 may be required

## STEERING DAMPER

Foam Cell			<b>3521</b>	1	\$167.00
-----------	--	--	-------------	---	----------

## U-BOLTS

Drivers Side U-Bolt Kit			<b>678UBK</b>	1	\$42.00
Near Side U-Bolt Kit			<b>437UBK</b>	1	\$42.00

## POLYURETHANE SPRING BUSHES

Bush Kit			<b>732UK</b>	1	\$70.00
----------	--	--	--------------	---	---------

## STEERING ARMS

Drop Drag Link			<b>ADL106</b>	1	\$278.00
----------------	--	--	---------------	---	----------

## GREASABLE SHACKLES AND PINS

Greasable Shackle			<b>384</b>	2	\$70.00
Greasable Pin			<b>385</b>	2	\$42.00

## REAR SUSPENSION

## SHOCK ABSORBER

Nitro Gas - Comfort			<b>12636GRC</b>	2	\$153.00
Nitro Gas - Performance			<b>12636GR</b>	2	\$153.00
Nitro Gas - Professional			<b>12636GRP</b>	2	\$153.00
Foam Cell - Comfort			<b>24636FEC</b>	2	\$222.00
Foam Cell - Performance			<b>24636FE</b>	2	\$222.00
Foam Cell - Professional			<b>24636FEP</b>	2	\$222.00

## LEAF SPRINGS

	Est. Lift	Additional Load			
Medium	50mm	0 - 300kg	<b>TOY011B</b>	2	\$375.00
Heavy	50mm	300kg - GVM	<b>TOY011C</b>	2	\$402.00

## U-BOLTS

U-Bolt Kit			<b>437UBK</b>	2	\$42.00
------------	--	--	---------------	---	---------

## POLYURETHANE SPRING BUSHES

Bush Kit			<b>733UK</b>	1	\$70.00
----------	--	--	--------------	---	---------

## GREASABLE SHACKLES AND PINS

Greasable Shackle			<b>386</b>	2	\$56.00
Greasable Shackle		Extended 5mm	<b>386-2</b>	2	\$56.00
Greasable Pin			<b>385</b>	2	\$42.00

## HELPER SPRINGS

Load Plus Helper Springs			<b>LP2</b>	1	\$157.00
Add-A-Leaf			<b>ISL6010</b>	1	\$167.00

## SUSPENSION KIT

Medium - Nitro Gas			<b>TOY010BKG1</b>		\$2078.00
Medium - Foam Cell			<b>TOY010BKF1</b>		\$2355.00
Heavy - Nitro Gas			<b>TOY010CKG1</b>		\$2134.00
Heavy - Foam Cell			<b>TOY010CKF1</b>		\$2411.00

• Specify front Leaf Springs when ordering

## SUSPENSION KIT CONTENTS

Shock Absorbers	U-Bolts
Leaf Springs	Polyurethane Spring Bushes



# Toyota Kluger

Kluger / Highlander  
2020+



Product Description

Part No.

Qty  
Req

Retail  
ea Inc GST

## SUSPENSION TO SUIT TOYOTA KLUGER / HIGHLANDER

### REAR SUSPENSION

#### COIL SPRINGS

	Est. Lift	Additional Load	Part No.	Qty	Retail Price
Heavy	40mm	200kg	TOY076C	1	\$250.00



200 Series (Facelift Mk II)  
11/2015+

# Toyota Landcruiser

Product Description	DATE AVAILABLE	Part No.	Qty Req	Retail ea Inc GST
<b>ACCESSORIES TO SUIT TOYOTA LANDCRUISER</b>				
<b>STEEL WINCH BULL BARS</b>				
Commercial - (GX models only - No Fog Lights)		BBC056		\$1648.00
Premium - 60.3mm Tube		BBP056-VX		\$2414.00
Polished Alloy		BBA056-VX		\$2844.00
Proguard No Loop		BBT056VX-NL		\$1888.00
Proguard Single Loop Kit		BB056-SL		\$336.00
Proguard Triple Loop Kit		BB056-TL		\$404.00
Driving Light Patch Loom		IPL056		\$31.00
• Winch with Steel Cable and Roller Fairlead is not suitable when front camera is used - Use Winch with Synthetic Rope and Alloy Hawse only				
<b>STEEL SIDE STEPS AND RAILS</b>				
Premium Side Steps - 60.3mm Tube (Suit non KDSS model)		SSP056		\$1055.00
Premium Side Rails - 60.3mm Tube (Suit non KDSS model)		SSP056 RAIL		\$384.00
Premium Side Steps and Rails - 60.3mm Tube (Suit non KDSS model)		SSRP056		\$1276.00
<b>RECOVERY POINTS - IRONMAN 4X4 BULL BAR ONLY</b>				
Recovery Points - 5000kg Rating (Pair) (Suit KDSS and non KDSS model)	Q1 2022	IRP056		\$227.00
<b>SNORKEL</b>				
Landcruiser 200 Series		ISNORKEL056		\$418.00
<b>LOCKSAFE DRAWER SYSTEMS</b>				
Twin Drawers - 1000mm		ITD1000		\$1296.00
Single Drawer - 1000mm		ISD1000		\$784.00
Wing Kit - 1000mm (May impede access to rear 240V outlet)		ITDW020		\$270.00
<b>BATTERY TRAY</b>				
Suits 12" Battery		IBTRAY056		\$149.00
<b>STEEL ROOF RACKS</b>				
Cage Style - 1.8m x 1.25m		IRRCAGE18		\$815.00
Rooftop Tent Compatible - 1.8m x 1.25m		IRRTENT18		\$777.00
Trade Style - 1.8m x 1.25m (Open end)		IRRTRADE18		\$777.00
<b>ALLOY ROOF RACKS</b>				
Cage Style - 1.8m x 1.25m		IRRCAGE18-ALLOY		\$1149.00
Trade Style - 1.8m x 1.25m (Open end)		IRRTRADE18-ALLOY		\$1132.00
Flat Rack - 1.8m x 1.25m		IRRTFLAT18-ALLOY		\$1116.00
<b>ROOF RACK - MOUNTING KITS</b>				
Landcruiser 200 Mount Feet - 200mm (8 Feet)		IRRFEETLC200		\$198.00
<b>PREMIUM UNDERBODY PROTECTION</b>				
Engine and Radiator		UBP056		\$748.00
<b>EXHAUST SYSTEM</b>				
3" Exhaust Upgrade 4.5L V8 - DPF Back - <i>While Stocks Last</i>		IEX056		\$961.00
<b>SEAT COVER</b>				
Canvas Comfort - Front (Without Headrest Monitors)		ICSC043F		\$401.00
Canvas Comfort - Rear		ICSC043R		\$401.00
<b>DIFF BREATHER KIT</b>				
Diff Breather Kit		IDIFFBRE		\$115.00

LISTING  
CONTINUED  
OVER THE  
PAGE



Product Description

Part No.

Qty  
Req

Retail  
ea Inc GST

## SUSPENSION TO SUIT TOYOTA LANDCRUISER

### FRONT SUSPENSION

#### SHOCK ABSORBER

Nitro Gas Strut - Performance			<b>12720GR</b>	2	\$250.00
Foam Cell Strut - Performance			<b>24720FE</b>	2	\$278.00
Foam Cell Pro Strut - Performance			<b>45720FE</b>	2	\$388.00

• Height adjustable with Ironman 4x4 Strut Trim Packers

#### COIL SPRINGS

	Est. Lift	Additional Load			
Standard	0mm	0-50kg	<b>TOY063S</b>	1	\$250.00
Light	25mm	0 - 50kg	<b>TOY063A</b>	1	\$250.00
Medium	50mm	0 - 50kg	<b>TOY063B</b>	1	\$250.00
Heavy	50mm	50 - 110kg	<b>TOY063C</b>	1	\$250.00

#### STRUT MOUNTS

Steel Strut Top			<b>ISST004</b>	2	\$84.00
-----------------	--	--	----------------	---	---------

#### TRIM PACKERS

5mm Strut Trim Packer	Nitro Gas / Foam Cell	<b>HILFR05 / HILFR05F</b>	2	\$28.00
10mm Strut Trim Packer	Nitro Gas / Foam Cell	<b>HILFR10 / HILFR10F</b>	2	\$28.00
15mm Strut Trim Packer	Nitro Gas / Foam Cell	<b>HILFR15 / HILFR15F</b>	2	\$28.00

• Only compatible with Ironman 4x4 Struts (except Pro), lift height subject to 2:1 motion ratio. Unnecessary fitment may lift vehicle too high

#### SWAY BAR

38mm Sway Bar	Non KDSS Models Only	<b>ISB200F</b>	1	\$582.00
---------------	----------------------	----------------	---	----------

#### CONTROL ARMS

Pro-Forge Upper Control Arms		<b>UCA056FA</b>	1	\$882.00
------------------------------	--	-----------------	---	----------

### REAR SUSPENSION

#### SHOCK ABSORBER

Nitro Gas - Performance			<b>12796GR</b>	2	\$153.00
Foam Cell - Performance			<b>24796FE</b>	2	\$222.00
Foam Cell Pro - Performance			<b>45796FE</b>	2	\$305.00
Foam Cell Pro - Professional			<b>45796FEP</b>	2	\$305.00

#### COIL SPRINGS

	Est. Lift	Additional Load			
Standard	0mm	0 - 200kg	<b>TOY064S</b>	1	\$264.00
Light	25mm	0 - 200kg	<b>TOY064A</b>	1	\$264.00
Medium	50mm	0 - 300kg	<b>TOY064B</b>	1	\$264.00
Medium - with Accessories	50mm	100 - 400kg	<b>TOY064EA</b>	1	\$264.00
Heavy	50mm	400 - 800kg	<b>TOY064C</b>	1	\$278.00
Extra Heavy	50mm	800kg+	<b>TOY064D</b>	1	\$416.00

#### PANHARD ROD

Adjustable Panhard Rod			<b>PANHARD016</b>	1	\$319.00
------------------------	--	--	-------------------	---	----------

#### ADJUSTABLE TRAILING ARM

Upper Trailing Arm			<b>UTA200</b>	1	\$208.00
Lower Trailing Arm			<b>LTA200</b>	1	\$264.00

#### SWAY BAR

33mm Sway Bar	Non KDSS Models Only	<b>ISB200R</b>	1	\$582.00
---------------	----------------------	----------------	---	----------



200 Series (Facelift Mk II)  
11/2015+

# Toyota Landcruiser

Product Description

Part No.

Qty  
Req

Retail  
ea Inc GST

### SUSPENSION KIT

Light - Nitro Gas	TOY063AKG	\$1316.00
Light - Foam Cell	TOY063AKF	\$1510.00
Light - Foam Cell Pro	TOY063AKP	\$1898.00
Medium - Nitro Gas	TOY063BKG	\$1316.00
Medium - Foam Cell	TOY063BKF	\$1510.00
Medium - Foam Cell Pro	TOY063BKP	\$1898.00
Heavy - Nitro Gas	TOY063CKG	\$1330.00
Heavy - Foam Cell	TOY063CKF	\$1524.00
Heavy - Foam Cell Pro	TOY063CKP	\$1912.00

- All kits compatible with KDSS, refer KDSS instructions available at [www.ironman4x4.com](http://www.ironman4x4.com)
- Specify front Coil Springs when ordering

### SUSPENSION KIT CONTENTS

Shock Absorbers	Strut Shock Absorbers
Coil Springs	



OPTIONS AVAILABLE FOR THIS VEHICLE - SEE PAGE 387

# Toyota Landcruiser

200 Series  
11/2007 to 1/2012  
(Facelift) 2/2012 to 10/2015



Product Description

DATE AVAILABLE

Part No.

Qty  
ReqRetail  
ea Inc GST

## ACCESSORIES TO SUIT TOYOTA LANDCRUISER

### STEEL WINCH BULL BARS

Commercial - (2/2012 to 9/2015) - <i>While Stocks Last</i>	<b>BBC043</b>	\$1648.00
Premium - 60.3mm Tube - (11/2007 to 1/2012)	<b>BBP025</b>	\$2371.00
Premium - 60.3mm Tube - (2/2012 to 9/2015)	<b>BBP043</b>	\$2371.00

### RECOVERY POINTS - IRONMAN 4X4 BULL BAR ONLY

Recovery Points - 5000kg Rating (Pair) - KDSS and non KDSS models	<b>Q1 2022</b>	<b>IRP056</b>	\$227.00
---	----------------	---------------	----------

### LOCKSAFE DRAWER SYSTEMS

Twin Drawers - 1000mm	<b>ITD1000</b>	\$1296.00
Single Drawer - 1000mm	<b>ISD1000</b>	\$784.00
Wing Kit - 1000mm (May impede access to rear 240V outlet)	<b>ITDW020</b>	\$270.00

### SNORKEL

Landcruiser 200 Series	<b>ISNORKELO10</b>	\$418.00
------------------------	--------------------	----------

### STEEL ROOF RACKS

Cage Style - 1.8m x 1.25m	<b>IRRCAGE18</b>	\$815.00
Cage Style - 2.2m x 1.25m	<b>IRRCAGE22</b>	\$846.00
Rooftop Tent Compatible - 1.8m x 1.25m	<b>IRRTENT18</b>	\$777.00
Rooftop Tent Compatible - 2.2m x 1.25m	<b>IRRTENT22</b>	\$815.00
Trade Style - 1.8m x 1.25m (Open end)	<b>IRRTRADE18</b>	\$777.00
Trade Style - 2.2m x 1.25m (Open end)	<b>IRRTRADE22</b>	\$809.00

### ALLOY ROOF RACKS

Cage Style - 1.8m x 1.25m	<b>IRRCAGE18-ALLOY</b>	\$1149.00
Cage Style - 2.2m x 1.25m	<b>IRRCAGE22-ALLOY</b>	\$1212.00
Trade Style - 1.8m x 1.25m (Open end)	<b>IRRTRADE18-ALLOY</b>	\$1132.00
Trade Style - 2.2m x 1.25m (Open end)	<b>IRRTRADE22-ALLOY</b>	\$1181.00
Flat Rack - 1.8m x 1.25m	<b>IRRTFLAT18-ALLOY</b>	\$1116.00

### ROOF RACK - MOUNTING KITS

Landcruiser 200 Mount Feet - 200mm (8 Feet)	<b>IRRFEETLC200</b>	\$198.00
---	---------------------	----------

### PREMIUM UNDERBODY PROTECTION

Engine and Radiator	<b>UBP056</b>	\$748.00
---------------------	---------------	----------

### UNDERBODY PROTECTION

Engine Bay and Transmission - <i>While Stocks Last</i>	<b>IUP004K</b>	\$636.00
Fuel Tank - <i>While Stocks Last</i>	<b>IUP004F</b>	\$307.00

• Fuel tank protection plates are not compatible with long range fuel tanks.

### SEAT COVER

Canvas Comfort - Front	<b>ICSC043F</b>	\$401.00
Canvas Comfort - Rear	<b>ICSC043R</b>	\$401.00

### DIFF BREATHER KIT

Diff Breather Kit	<b>IDIFFBRE</b>	\$115.00
-------------------	-----------------	----------





200 Series  
11/2007 to 10/2015

# Toyota Landcruiser

Product Description

Part No.

Qty  
ReqRetail  
ea Inc GST

## SUSPENSION TO SUIT TOYOTA LANDCRUISER

### FRONT SUSPENSION

#### SHOCK ABSORBER

Nitro Gas Strut - Performance			<b>12720GR</b>	2	\$250.00
Foam Cell Strut - Performance			<b>24720FE</b>	2	\$278.00
Foam Cell Pro Strut - Performance			<b>45720FE</b>	2	\$388.00

• Height adjustable with Ironman 4x4 Strut Trim Packers

#### COIL SPRINGS

	Est. Lift	Additional Load			
Standard	0mm	0-50kg	<b>TOY063S</b>	1	\$250.00
Light	25mm	0 - 50kg	<b>TOY063A</b>	1	\$250.00
Medium	50mm	0 - 50kg	<b>TOY063B</b>	1	\$250.00
Heavy	50mm	50 - 110kg	<b>TOY063C</b>	1	\$250.00

#### STRUT MOUNTS

Steel Strut Top			<b>ISST004</b>	2	\$84.00
-----------------	--	--	----------------	---	---------

#### TRIM PACKERS

5mm Strut Trim Packer	Nitro Gas / Foam Cell	<b>HILFR05 / HILFR05F</b>	2	\$28.00
10mm Strut Trim Packer	Nitro Gas / Foam Cell	<b>HILFR10 / HILFR10F</b>	2	\$28.00
15mm Strut Trim Packer	Nitro Gas / Foam Cell	<b>HILFR15 / HILFR15F</b>	2	\$28.00

• ONLY Compatible with Ironman 4x4 Struts (except Pro), lift height subject to 2:1 motion ratio. Unnecessary fitment may lift vehicle too high

#### SWAY BAR

38mm Sway Bar	Non KDSS Models Only	<b>ISB200F</b>	1	\$582.00
---------------	----------------------	----------------	---	----------

#### CONTROL ARMS

Pro-Forge Upper Control Arms		<b>UCA056FA</b>	1	\$882.00
------------------------------	--	-----------------	---	----------

### REAR SUSPENSION

#### SHOCK ABSORBER

Nitro Gas - Performance			<b>12796GR</b>	2	\$153.00
Foam Cell - Performance			<b>24796FE</b>	2	\$222.00
Foam Cell Pro - Performance			<b>45796FE</b>	2	\$305.00
Foam Cell Pro - Professional			<b>45796FEP</b>	2	\$305.00

#### COIL SPRINGS

	Est. Lift	Additional Load			
Standard	0mm	0 - 200kg	<b>TOY064S</b>	1	\$264.00
Light	25mm	0 - 200kg	<b>TOY064A</b>	1	\$264.00
Medium	50mm	0 - 300kg	<b>TOY064B</b>	1	\$264.00
Medium - with Accessories	50mm	100 - 400kg	<b>TOY064EA</b>	1	\$264.00
Heavy	50mm	400kg - GVM	<b>TOY064C</b>	1	\$278.00
Extra Heavy	50mm	800kg+	<b>TOY064D</b>	1	\$416.00

#### PANHARD ROD

Adjustable Panhard Rod			<b>PANHARD016</b>	1	\$319.00
------------------------	--	--	-------------------	---	----------

#### ADJUSTABLE TRAILING ARM

Upper Trailing Arm			<b>UTA200</b>	1	\$208.00
Lower Trailing Arm			<b>LTA200</b>	1	\$264.00

#### SWAY BAR

33mm Sway Bar	Non KDSS Models Only	<b>ISB200R</b>	1	\$582.00
---------------	----------------------	----------------	---	----------

### SUSPENSION KIT

Light - Nitro Gas	<b>TOY063AKG</b>	\$1316.00
Light - Foam Cell	<b>TOY063AKF</b>	\$1510.00
Light - Foam Cell Pro	<b>TOY063AKP</b>	\$1898.00
Medium - Nitro Gas	<b>TOY063BKG</b>	\$1316.00
Medium - Foam Cell	<b>TOY063BKF</b>	\$1510.00
Medium - Foam Cell Pro	<b>TOY063BKP</b>	\$1898.00
Heavy - Nitro Gas	<b>TOY063CKG</b>	\$1330.00
Heavy - Foam Cell	<b>TOY063CKF</b>	\$1524.00
Heavy - Foam Cell Pro	<b>TOY063CKP</b>	\$1912.00

• All kits compatible with KDSS, refer KDSS instructions available at [www.ironman4x4.com](http://www.ironman4x4.com)

• Specify front Coil Springs when ordering

### SUSPENSION KIT CONTENTS

Shock Absorbers	Strut Shock Absorbers
Coil Springs	



# Toyota Landcruiser

Product Description

Part No.

Qty  
Req

Retail  
ea Inc GST

## ACCESSORIES TO SUIT TOYOTA LANDCRUISER

### STEEL WINCH BULL BARS

Commercial Deluxe

**BBCD005**

\$2244.00

### RECOVERY POINTS - IRONMAN 4X4 BULL BAR ONLY

Recovery Points - 5000kg Rating (Pair)

**IRP005**

\$217.00

### LOCKSAFE DRAWER SYSTEMS

Twin Drawers - 1000mm

**ITD1000**

\$1296.00

Single Drawer - 1000mm

**ISD1000**

\$784.00

Wing Kit - 1000mm (GXL 1998 to 2005)

**ITDW018**

\$270.00

### SNORKEL

Landcruiser 105 Series

**ISNORKEL003**

\$418.00

### STEEL ROOF RACKS

Cage Style - 1.8m x 1.25m

**IRRCAGE18**

\$815.00

Rooftop Tent Compatible - 1.8m x 1.25m

**IRRTENT18**

\$777.00

Trade Style - 1.8m x 1.25m (Open end)

**IRRTRADE18**

\$777.00

### ALLOY ROOF RACKS

Cage Style - 1.8m x 1.25m

**IRRCAGE18-ALLOY**

\$1149.00

Trade Style - 1.8m x 1.25m (Open end)

**IRRTRADE18-ALLOY**

\$1132.00

Flat Rack - 1.8m x 1.25m

**IRRFLAT18-ALLOY**

\$1116.00

### ROOF RACK - MOUNTING KITS

Landcruiser 100 Mount Feet - 100mm (8 Feet)

**IRRFEETLC100**

\$198.00

### DIFF BREATHER KIT

Diff Breather Kit

**IDIFFBRE**

\$115.00





105 Series  
1998+

# Toyota Landcruiser

Product Description

Part No.

Qty  
ReqRetail  
ea Inc GST

## SUSPENSION TO SUIT TOYOTA LANDCRUISER

### FRONT SUSPENSION

#### SHOCK ABSORBER

Nitro Gas - Performance			<b>12683GR</b>	2	\$153.00
Foam Cell - Performance			<b>24683FE</b>	2	\$222.00
Foam Cell - Performance		Suits 4" Lift	<b>24683LFE</b>	2	\$250.00
Foam Cell - Performance		Suits 6" Lift	<b>24683LFE1</b>	2	\$278.00
Foam Cell Pro - Performance			<b>45683FE</b>	2	\$305.00
Foam Cell Pro - Performance		Suits 4" Lift	<b>45683LFE</b>	2	\$319.00
Foam Cell Pro - Performance		Suits 6" Lift	<b>45683LFE1</b>	2	\$333.00

#### COIL SPRINGS

	Est. Lift	Additional Load			
Medium	50mm	0 - 50kg	<b>TOY024B</b>	1	\$250.00
Medium - 4" Lift	100mm	0 - 100kg	<b>TOY012C</b>	1	\$388.00
Medium - 6" Lift	150mm	0 - 100kg	<b>TOY060B</b>	1	\$458.00
Heavy	50mm	50 - 110kg	<b>TOY024C</b>	1	\$250.00

#### STEERING DAMPER

Foam Cell			<b>3524</b>	1	\$167.00
-----------	--	--	-------------	---	----------

#### CASTER CORRECTION

2° Offset Bush Kit - Polyurethane			<b>1144SK</b>	1	\$153.00
Adjustable Offset STD, 2.5, 3.5° - Polyurethane			<b>1144</b>	1	\$153.00
2° Offset Bush Kit - Rubber			<b>1144RK</b>	1	\$153.00
5° Offset Plate Kit			<b>CPLATE001</b>	1	\$222.00
4° Drop Box			<b>DBOX001</b>	1	\$388.00

#### STEERING RODS

Adjustable Drag Link	Right Hand Drive		<b>ADL001</b>	1	\$416.00
Adjustable Drag Link	Left Hand Drive		<b>ADL001L</b>	1	\$416.00
Track Rod			<b>ATR001</b>	1	\$416.00

#### ADJUSTABLE PANHARD ROD

Right Hand Drive Rod			<b>PANHARD001</b>	1	\$319.00
Left Hand Drive Rod			<b>PANHARD007</b>	1	\$319.00

#### SWAY BAR LINK

Extended Sway Bar Link			<b>SBEXT001</b>	2	\$28.00
------------------------	--	--	-----------------	---	---------

#### COIL SPACER

Polyurethane 20mm			<b>LCF20</b>	2	\$28.00
Polyurethane 30mm			<b>LCF30</b>	2	\$42.00

#### EXTENDED BRAKE HOSE

Single Hose Models			<b>BHOSE001</b>	1	\$70.00
Dual Hose Models			<b>BHOSE002</b>	2	\$70.00

### REAR SUSPENSION

#### SHOCK ABSORBER

Nitro Gas - Performance			<b>12682GR</b>	2	\$153.00
Foam Cell - Performance			<b>24682FE</b>	2	\$222.00
Foam Cell - Performance		Suits 4" Lift	<b>24682LFE</b>	2	\$250.00
Foam Cell - Performance		Suits 6" Lift	<b>24682LFE1</b>	2	\$278.00
Foam Cell Pro - Performance			<b>45682FE</b>	2	\$305.00
Foam Cell Pro - Performance		Suits 4" Lift	<b>45682LFE</b>	2	\$319.00
Foam Cell Pro - Performance		Suits 6" Lift	<b>45682LFE1</b>	2	\$333.00

#### COIL SPRINGS

	Est. Lift	Additional Load			
Medium	50mm	0 - 200kg	<b>TOY025B</b>	1	\$250.00
Medium - with Accessories	50mm	100 - 300kg	<b>TOY013B</b>	1	\$250.00
Medium - 4" Lift	100mm	0 - 300kg	<b>TOY013C</b>	1	\$388.00
Medium - 6" Lift	150mm	0 - 300kg	<b>TOY061B</b>	1	\$458.00
Heavy	50mm	200 - 400kg	<b>TOY025C</b>	1	\$264.00
Heavy - 4" Lift	100mm	300 - 500kg	<b>TOY013D</b>	1	\$416.00
Heavy - 6" Lift	150mm	300 - 500kg	<b>TOY061C</b>	1	\$458.00
Extra Heavy	55mm	400 - 500kg	<b>TOY025D</b>	1	\$416.00

LISTING  
CONTINUED  
OVER THE  
PAGE



# Toyota Landcruiser

105 Series  
1998+



Product Description

Part No.

Qty  
Req

Retail  
ea Inc GST

**PANHARD ROD**

Adjustable Panhard Rod **PANHARD002** 1 \$319.00

**ADJUSTABLE TRAILING ARM**

Upper Trailing Arm **UTA001** 2 \$208.00

Lower Trailing Arm **LTA001** 2 \$264.00

**SWAY BAR LINK**

Extended Sway Bar Link Side mount **SBEXT002** 2 \$28.00

Extended Sway Bar Link Under mount **SBEXT005** 2 \$28.00

**COIL SPACER**

Polyurethane 15mm **LCR15** 2 \$28.00

Polyurethane 30mm **LCR30** 2 \$42.00

**BRAKE HOSE**

Extended Brake Hose **BHOSE002** 1 \$70.00

**BUSH KIT**

Rubber Suspension Arm Bush Kit W/ Standard Radius Arm Bushes **847RK** 1 \$402.00

Rubber Suspension Arm Bush Kit W/ Offset Radius Arm Bushes **847CRK** 1 \$402.00

**SUSPENSION KIT**

Medium - Nitro Gas **TOY024BKG** \$1109.00

Medium - Foam Cell **TOY024BKF** \$1386.00

Medium - Foam Cell 4" Lift RH Drive **TOY012CKF1** \$3754.00

Medium - Foam Cell 4" Lift LH Drive **TOY012CKF1L** \$3754.00

Medium - Foam Cell 6" Lift RH Drive **TOY063BKF1** \$4004.00

Medium - Foam Cell 6" Lift LH Drive **TOY063BKF1L** \$4004.00

Medium - Foam Cell Pro **TOY024BKP** \$1718.00

Medium - Foam Cell Pro 4" Lift RH Drive **TOY012CKP1** \$4031.00

Medium - Foam Cell Pro 4" Lift LH Drive **TOY012CKP1L** \$4031.00

Medium - Foam Cell Pro 6" Lift RH Drive **TOY063BKP1** \$4225.00

Medium - Foam Cell Pro 6" Lift LH Drive **TOY063BKP1L** \$4225.00

Heavy - Nitro Gas **TOY024CKG** \$1123.00

Heavy - Foam Cell **TOY024CKF** \$1400.00

Heavy - Foam Cell 4" Lift RH Drive **TOY012CKF2** \$3754.00

Heavy - Foam Cell 4" Lift LH Drive **TOY012CKF2L** \$3782.00

Heavy - Foam Cell 6" Lift RH Drive **TOY063BKF2** \$4004.00

Heavy - Foam Cell 6" Lift LH Drive **TOY063BKF2L** \$4004.00

Heavy - Foam Cell Pro **TOY024CKP** \$1732.00

Heavy - Foam Cell Pro 4" Lift RH Drive **TOY012CKP2** \$4031.00

Heavy - Foam Cell Pro 4" Lift LH Drive **TOY012CKP2L** \$4059.00

Heavy - Foam Cell Pro 6" Lift RH Drive **TOY063BKP2** \$4225.00

Heavy - Foam Cell Pro 6" Lift LH Drive **TOY063BKP2L** \$4225.00

Extra Heavy - Nitro Gas **TOY024DKG** \$1275.00

Extra Heavy - Foam Cell **TOY024DKF** \$1552.00

Extra Heavy - Foam Cell Pro **TOY024DKP** \$1884.00

- 4" and 6" lifts may not be legal for on-road use in your area, certification may be required for on-road use
- Due to the extreme nature of 4" and 6" lifts, further modifications may be required, and will vary between vehicles, such modifications are entirely the owners responsibility
- Ironman 4x4 accept no responsibility for any damage or injury caused by use of these products
- Specify front Coil Springs when ordering

**50MM SUSPENSION KIT CONTENTS**

Shock Absorbers Coil Springs

**4" AND 6" SUSPENSION KIT CONTENTS**

Shock Absorbers  
Coil Springs  
Panhard Rods  
Sway Bar Links  
Caster Plates  
Brake Hoses  
Adjustable Trailing Arms





100 Series HDJ100, UZJ100, IFS  
3/1998 to 10/2007

# Toyota Landcruiser

Product Description

Part No.

Qty  
Req

Retail  
ea Inc GST

## ACCESSORIES TO SUIT TOYOTA LANDCRUISER

### STEEL WINCH BULL BARS

Commercial Deluxe **BBCD006** \$2244.00

### RECOVERY POINTS - IRONMAN 4X4 BULL BAR ONLY

Recovery Points - 5000kg Rating (Pair) **IRP005** \$217.00

### LOCKSAFE DRAWER SYSTEMS

Twin Drawers - 1000mm **ITD1000** \$1296.00

Single Drawer - 1000mm **ISD1000** \$784.00

Wing Kit - 1000mm (GXL 1998 to 2005) **ITDW018** \$270.00

Wing Kit - 1000mm (2005+) **ITDW019** \$270.00

Wing Kit - 1000mm (DX) **ITDW017** \$270.00

### SNORKEL

Landcruiser 100 / Lexus LX 470 **ISNORKEL003** \$418.00

### STEEL ROOF RACKS

Cage Style - 1.8m x 1.25m **IRRCAGE18** \$815.00

Rooftop Tent Compatible - 1.8m x 1.25m **IRRTENT18** \$777.00

Trade Style - 1.8m x 1.25m (Open end) **IRRTRADE18** \$777.00

### ALLOY ROOF RACKS

Cage Style - 1.8m x 1.25m **IRRCAGE18-ALLOY** \$1149.00

Trade Style - 1.8m x 1.25m (Open end) **IRRTRADE18-ALLOY** \$1132.00

Flat Rack - 1.8m x 1.25m **IRRTFLAT18-ALLOY** \$1116.00

### ROOF RACK - MOUNTING KITS

Landcruiser 100 Mount Feet - 100mm (8 Feet) **IRRFEETLC100** \$198.00

### DIFF BREATHER KIT

Diff Breather Kit **IDIFFBRE** \$115.00



# Toyota Landcruiser

100 Series, IFS  
1998+



Product Description

Part No.

Qty  
Req

Retail  
ea Inc GST

## SUSPENSION TO SUIT TOYOTA LANDCRUISER

### FRONT SUSPENSION

#### SHOCK ABSORBER

Nitro Gas - Performance			<b>12795GR</b>	2	\$153.00
Foam Cell - Performance			<b>24795FE</b>	2	\$222.00
Foam Cell Pro - Performance			<b>45795FE</b>	2	\$305.00

#### TORSION BAR

Uprated Torsion Bars	Petrol Models	1160mm Length	<b>TOY050</b>	1	\$499.00
Uprated Torsion Bars	Diesel Models	1210mm Length	<b>TOY051</b>	1	\$499.00

- Must Install BRACKET100
- Some Middle Eastern Petrol models use TOY051 check length before ordering
- Minimum 60mm downward suspension travel required after adjustment

#### DIFF DROP KIT

Diff Drop Kit			<b>IDD100</b>	1	\$388.00
---------------	--	--	---------------	---	----------

#### CONTROL ARM

Control Arm Reinforcement			<b>BRACKET100</b>	1	\$42.00
---------------------------	--	--	-------------------	---	---------

### REAR SUSPENSION

#### SHOCK ABSORBER

Nitro Gas - Performance			<b>12796GR</b>	2	\$153.00
Foam Cell - Performance			<b>24796FE</b>	2	\$222.00
Foam Cell Pro - Performance			<b>45796FE</b>	2	\$305.00
Foam Cell Pro - Professional			<b>45796FEP</b>	2	\$305.00

#### COIL SPRINGS

	Est. Lift	Additional Load			
Medium	25mm	0 - 200kg	<b>TOY013B</b>	1	\$250.00
Heavy	25mm	200 - 400kg	<b>TOY025C</b>	1	\$264.00
Extra Heavy	30mm	400kg - GVM	<b>TOY025D</b>	1	\$416.00

#### ADJUSTABLE TRAILING ARM

Upper Trailing Arm			<b>UTA003</b>	2	\$208.00
Lower Trailing Arm			<b>LTA003</b>	2	\$264.00

### SUSPENSION KIT

Medium - Nitro Gas	Petrol	<b>TOY050BKG</b>	\$1400.00
Medium - Nitro Gas	Diesel	<b>TOY051BKG</b>	\$1400.00
Medium - Foam Cell	Petrol	<b>TOY050BKF</b>	\$1677.00
Medium - Foam Cell	Diesel	<b>TOY051BKF</b>	\$1677.00
Medium - Foam Cell Pro	Petrol	<b>TOY050BKP</b>	\$2009.00
Medium - Foam Cell Pro	Diesel	<b>TOY051BKP</b>	\$2009.00
Heavy - Nitro Gas	Petrol	<b>TOY050CKG</b>	\$1413.00
Heavy - Nitro Gas	Diesel	<b>TOY051CKG</b>	\$1413.00
Heavy - Foam Cell	Petrol	<b>TOY050CKF</b>	\$1690.00
Heavy - Foam Cell	Diesel	<b>TOY051CKF</b>	\$1690.00
Heavy - Foam Cell Pro	Petrol	<b>TOY050CKP</b>	\$2023.00
Heavy - Foam Cell Pro	Diesel	<b>TOY051CKP</b>	\$2023.00
Extra Heavy - Nitro Gas	Petrol	<b>TOY050DKG</b>	\$1566.00
Extra Heavy - Nitro Gas	Diesel	<b>TOY051DKG</b>	\$1566.00
Extra Heavy - Foam Cell	Petrol	<b>TOY050DKF</b>	\$1843.00
Extra Heavy - Foam Cell	Diesel	<b>TOY051DKF</b>	\$1843.00
Extra Heavy - Foam Cell Pro	Petrol	<b>TOY050DKP</b>	\$2175.00
Extra Heavy - Foam Cell Pro	Diesel	<b>TOY051DKP</b>	\$2175.00

- Some Middle Eastern Petrol models use TOY051 check Torsion Bar length before ordering

### SUSPENSION KIT CONTENTS

Shock Absorbers	Torsion Bars
Coil Springs	Control Arm Reinforcement





80 Series HZJ80, FZJ80  
1990 to 1998

# Toyota Landcruiser

Product Description

Part No.

Qty  
Req

Retail  
ea Inc GST

## ACCESSORIES TO SUIT TOYOTA LANDCRUISER

### STEEL WINCH BULL BARS

Commercial Deluxe

BBCD004

\$2244.00

### RECOVERY POINTS - IRONMAN 4X4 BULL BAR ONLY

Recovery Points - 5000kg Rating (Pair)

IRP005

\$217.00

### LOCKSAFE DRAWER SYSTEMS

Twin Drawers - 1000mm

ITD1000

\$1296.00

Single Drawer - 1000mm

ISD1000

\$784.00

Wing Kit - 1000mm (GXL)

ITDW016

\$270.00

Wing Kit - 1000mm (DX)

ITDW015

\$270.00

### SNORKEL

Landcruiser / Lexus LX 450

ISNORKEL004

\$418.00

### STEEL ROOF RACKS

Cage Style - 1.4m x 1.25m

IRRCAGE14

\$777.00

Cage Style - 1.8m x 1.25m

IRRCAGE18

\$815.00

Cage Style - 2.2m x 1.25m

IRRCAGE22

\$846.00

Rooftop Tent Compatible - 1.8m x 1.25m

IRRTENT18

\$777.00

Rooftop Tent Compatible - 2.2m x 1.25m

IRRTENT22

\$815.00

Trade Style - 1.8m x 1.25m (Open end)

IRRTRADE18

\$777.00

Trade Style - 2.2m x 1.25m (Open end)

IRRTRADE22

\$809.00

### ALLOY ROOF RACKS

Cage Style - 1.4m x 1.25m

IRRCAGE14-ALLOY

\$983.00

Cage Style - 1.8m x 1.25m

IRRCAGE18-ALLOY

\$1149.00

Cage Style - 2.2m x 1.25m

IRRCAGE22-ALLOY

\$1212.00

Trade Style - 1.8m x 1.25m (Open end)

IRRTRADE18-ALLOY

\$1132.00

Trade Style - 2.2m x 1.25m (Open end)

IRRTRADE22-ALLOY

\$1181.00

Flat Rack - 1.8m x 1.25m

IRRTFLAT18-ALLOY

\$1116.00

### ROOF RACK - MOUNTING KITS

Gutter Mount Feet - 125mm (8 Feet)

IRRFEET125

\$198.00

### DIFF BREATHER KIT

Diff Breather Kit

IDIFFBRE

\$115.00



# Toyota Landcruiser

80 Series  
1990+



Product Description

Part No.

Qty  
Req

Retail  
ea Inc GST

## SUSPENSION TO SUIT TOYOTA LANDCRUISER

### FRONT SUSPENSION

#### SHOCK ABSORBER

Nitro Gas - Performance			<b>12683GR</b>	2	\$153.00
Foam Cell - Performance			<b>24683FE</b>	2	\$222.00
Foam Cell - Performance		Suits 4" Lift	<b>24683LFE</b>	2	\$250.00
Foam Cell - Performance		Suits 6" Lift	<b>24683LFE1</b>	2	\$278.00
Foam Cell Pro - Performance			<b>45683FE</b>	2	\$305.00
Foam Cell Pro - Performance		Suits 4" Lift	<b>45683LFE</b>	2	\$319.00
Foam Cell Pro - Performance		Suits 6" Lift	<b>45683LFE1</b>	2	\$333.00

#### COIL SPRINGS

	Est. Lift	Additional Load			
Medium	50mm	0 - 50kg	<b>TOY024B</b>	1	\$250.00
Medium - 4" Lift	100mm	0 - 100kg	<b>TOY012C</b>	1	\$388.00
Medium - 6" Lift	150mm	0 - 100kg	<b>TOY060B</b>	1	\$458.00
Heavy	50mm	50 - 110kg	<b>TOY024C</b>	1	\$250.00

#### STEERING DAMPER

Foam Cell			<b>3524</b>	1	\$167.00
-----------	--	--	-------------	---	----------

#### CASTER CORRECTION

2° Offset Bush Kit - Polyurethane			<b>1144SK</b>	1	\$153.00
Adjustable Offset STD, 2.5, 3.5° - Polyurethane			<b>1144</b>	1	\$153.00
2° Offset Bush Kit - Rubber			<b>1144RK</b>	1	\$153.00
5° Offset Plate Kit			<b>CPLATE001</b>	1	\$222.00
4° Drop Box			<b>DBOX001</b>	1	\$388.00

#### STEERING ROD

Adjustable Drag Link	Right Hand Drive		<b>ADL001</b>	1	\$416.00
Adjustable Drag Link	Left Hand Drive		<b>ADL001L</b>	1	\$416.00
Track Rod			<b>ATRO01</b>	1	\$416.00

#### ADJUSTABLE PANHARD ROD

Right Hand Drive Rod			<b>PANHARD001</b>	1	\$319.00
Left Hand Drive Rod			<b>PANHARD007</b>	1	\$319.00

#### SWAY BAR LINK

Extended Sway Bar Link			<b>SBEXT001</b>	2	\$28.00
------------------------	--	--	-----------------	---	---------

#### COIL SPACER

Polyurethane 20mm			<b>LCF20</b>	2	\$28.00
Polyurethane 30mm			<b>LCF30</b>	2	\$42.00

#### EXTENDED BRAKE HOSE

Single Hose Models			<b>BHOSE001</b>	1	\$70.00
Dual Hose Models			<b>BHOSE002</b>	2	\$70.00

### REAR SUSPENSION

#### SHOCK ABSORBER

Nitro Gas - Performance			<b>12682GR</b>	2	\$153.00
Foam Cell - Performance			<b>24682FE</b>	2	\$222.00
Foam Cell - Performance		Suits 4" Lift	<b>24682LFE</b>	2	\$250.00
Foam Cell - Performance		Suits 6" Lift	<b>24682LFE1</b>	2	\$278.00
Foam Cell Pro - Performance			<b>45682FE</b>	2	\$305.00
Foam Cell Pro - Performance		Suits 4" Lift	<b>45682LFE</b>	2	\$319.00
Foam Cell Pro - Performance		Suits 6" Lift	<b>45682LFE1</b>	2	\$333.00

#### COIL SPRINGS

	Est. Lift	Additional Load			
Medium	50mm	0 - 200kg	<b>TOY025B</b>	1	\$250.00
Medium - with Accessories	50mm	100 - 300kg	<b>TOY013B</b>	1	\$250.00
Medium - 4" Lift	100mm	0 - 300kg	<b>TOY013C</b>	1	\$388.00
Medium - 6" Lift	150mm	0 - 300kg	<b>TOY061B</b>	1	\$458.00
Heavy	50mm	200 - 400kg	<b>TOY025C</b>	1	\$264.00
Heavy - 4" Lift	100mm	300 - 500kg	<b>TOY013D</b>	1	\$416.00
Heavy - 6" Lift	150mm	300 - 500kg	<b>TOY061C</b>	1	\$458.00
Extra Heavy	55mm	400 - 500kg	<b>TOY025D</b>	1	\$416.00

#### PANHARD ROD

Adjustable Panhard Rod			<b>PANHARD002</b>	1	\$319.00
------------------------	--	--	-------------------	---	----------

#### ADJUSTABLE TRAILING ARM

Upper Trailing Arm			<b>UTA001</b>	2	\$208.00
Lower Trailing Arm			<b>LTA001</b>	2	\$264.00



80 Series  
1990+

# Toyota Landcruiser

**Product Description**

**Part No.**

**Qty  
Req**

**Retail  
ea Inc GST**

**SWAY BAR LINK**

Extended Sway Bar Link	Side Mount	<b>SBEXT002</b>	2	\$28.00
Extended Sway Bar Link	Under Mount	<b>SBEXT005</b>	2	\$28.00

**COIL SPACER**

Polyurethane 15mm		<b>LCR15</b>	2	\$28.00
Polyurethane 30mm		<b>LCR30</b>	2	\$42.00

**BUSH KIT**

Rubber Suspension Arm Bush Kit	W/ Standard Radius Arm Bushes	<b>847RK</b>	1	\$402.00
Rubber Suspension Arm Bush Kit	W/ Offset Radius Arm Bushes	<b>847CRK</b>	1	\$402.00

**SUSPENSION KIT**

Medium - Nitro Gas		<b>TOY024BKG</b>		\$1109.00
Medium - Foam Cell		<b>TOY024BKF</b>		\$1386.00
Medium - Foam Cell	4"Lift	RH Drive	<b>TOY012CKF1</b>	\$3754.00
Medium - Foam Cell	4"Lift	LH Drive	<b>TOY012CKF1L</b>	\$3754.00
Medium - Foam Cell	6"Lift	RH Drive	<b>TOY063BKF1</b>	\$4004.00
Medium - Foam Cell	6"Lift	LH Drive	<b>TOY063BKF1L</b>	\$4004.00
Medium - Foam Cell Pro			<b>TOY024BKP</b>	\$1718.00
Medium - Foam Cell Pro	4"Lift	RH Drive	<b>TOY012CKP1</b>	\$4031.00
Medium - Foam Cell Pro	4"Lift	LH Drive	<b>TOY012CKP1L</b>	\$4031.00
Medium - Foam Cell Pro	6"Lift	RH Drive	<b>TOY063BKP1</b>	\$4225.00
Medium - Foam Cell Pro	6"Lift	LH Drive	<b>TOY063BKP1L</b>	\$4225.00
Heavy - Nitro Gas			<b>TOY024CKG</b>	\$1123.00
Heavy - Foam Cell			<b>TOY024CKF</b>	\$1400.00
Heavy - Foam Cell	4"Lift	RH Drive	<b>TOY012CKF2</b>	\$3754.00
Heavy - Foam Cell	4"Lift	LH Drive	<b>TOY012CKF2L</b>	\$3782.00
Heavy - Foam Cell	6"Lift	RH Drive	<b>TOY063BKF2</b>	\$4004.00
Heavy - Foam Cell	6"Lift	LH Drive	<b>TOY063BKF2L</b>	\$4004.00
Heavy - Foam Cell Pro			<b>TOY024CKP</b>	\$1732.00
Heavy - Foam Cell Pro	4"Lift	RH Drive	<b>TOY012CKP2</b>	\$4031.00
Heavy - Foam Cell Pro	4"Lift	LH Drive	<b>TOY012CKP2L</b>	\$4059.00
Heavy - Foam Cell Pro	6"Lift	RH Drive	<b>TOY063BKP2</b>	\$4225.00
Heavy - Foam Cell Pro	6"Lift	LH Drive	<b>TOY063BKP2L</b>	\$4225.00
Extra Heavy - Nitro Gas			<b>TOY024DKG</b>	\$1275.00
Extra Heavy - Foam Cell			<b>TOY024DKF</b>	\$1552.00
Extra Heavy - Foam Cell Pro			<b>TOY024DKP</b>	\$1884.00

- 4" and 6" lifts may not be legal for on-road use in your area, certification may be required for on-road use
- Due to the extreme nature of 4" and 6" lifts, further modifications may be required, and will vary between vehicles, such modifications are entirely the owners responsibility
- Ironman 4x4 accept no responsibility for any damage or injury caused by use of these products
- Specify front Coil Springs when ordering

**50MM SUSPENSION KIT CONTENTS**

Shock Absorbers                      Coil Springs

**4" AND 6" SUSPENSION KIT CONTENTS**

Shock Absorbers                      Caster Plates  
 Coil Springs                              Brake Hoses  
 Panhard Rods                           Adjustable Trailing Arms  
 Sway Bar Links





# Toyota Landcruiser

Product Description

Part No.

Qty  
ReqRetail  
ea Inc GST

## ACCESSORIES TO SUIT TOYOTA LANDCRUISER 79 SERIES SINGLE CAB

### STEEL WINCH BULL BARS (NO SIDE PLATES ON BAR)

Commercial - (9/2016+ Only)	BBC019SC	\$1648.00
Commercial - (2007 to 8/2016 Only)	BBC019E	\$1648.00
Commercial - (1999 to 2007 Only)	BBC018	\$1498.00
Commercial Deluxe - (1999 to 2007 Only)	BBCD018	\$2244.00
Protector - (9/2016+ Only)	BBT019SC	\$2271.00
Premium - 60.3mm Tube - (9/2016+ Only)	BBP019SC	\$2098.00
Premium - 60.3mm Tube - (2007 to 8/2016 Only)	BBP019E	\$2098.00

### STEEL SIDE STEPS AND RAILS

Side Steps - (9/2016+ Only)	SS019SC	\$962.00
Side Steps - (2007 to 8/2016 Only)	SS016	\$962.00
Side Rails - (9/2016+ Only)	SS019SC RAIL	\$317.00
Side Steps and Rails - (9/2016+ Only)	SSR019SC	\$1155.00
Side Steps and Rails - (2007 to 8/2016 Only)	SSR016	\$1155.00
Premium Side Steps - 60.3mm Tube - (9/2016+ Only)	SSP019SC	\$1055.00
Premium Side Rails - 60.3mm Tube - (9/2016+ Only)	SSP019SC RAIL	\$384.00
Premium Side Steps and Rails - 60.3mm Tube - (9/2016+ Only)	SSRP019SC	\$1276.00
Premium Side Steps and Rails - 60.3mm Tube - (2007 to 8/2016 Only)	SSRP016	\$1276.00

### RECOVERY POINTS - IRONMAN 4X4 BULL BAR ONLY

Recovery Points - 5000kg Rating (Pair) - (9/2016+ Only)	IRP019SC	\$234.00
Recovery Points - 5000kg Rating (Pair) - (2007 to 8/2016 Only)	IRP019	\$234.00

### SNORKEL

Landcruiser 79 Series V8 - (2007+ Only)	ISNORKELO23	\$418.00
Landcruiser 4.2L 1HZ Diesel - (1999 to 2007 Only)	ISNORKELO09	\$418.00

### PREMIUM UNDERBODY PROTECTION

Radiator and Steering Rods - (9/2016+ Only)	UBP019SC	\$290.00
Radiator and Steering Rods - (2007 to 8/2016 Only)	UBP019	\$290.00

### SEAT COVER

Canvas Comfort - Front - (9/2016+ Only)	ICSC019SCF	\$401.00
Canvas Comfort - Front Bucket Pair - (2007 to 8/2016 Only)	ICSC019F	\$401.00
Canvas Comfort - Front Bucket and 3/4 Bench - (2007 to 8/2016 Only)	ICSC019F3/4	\$401.00

### DIFF BREATHER KIT

Diff Breather Kit	IDIFFBRE	\$115.00
-------------------	----------	----------



79 Series (V8 TD) Single Cab  
9/2016+  
2007 to 8/2016  
1999 to 2007

**SUSPENSION TO SUIT**

# Toyota Landcruiser

Product Description

Part No.

Qty  
Req

Retail  
ea Inc GST

## SUSPENSION TO SUIT TOYOTA LANDCRUISER 79 SERIES SINGLE CAB

### FRONT SUSPENSION

#### SHOCK ABSORBER

Nitro Gas - Performance			<b>12091GR</b>	2	\$153.00
Foam Cell - Performance			<b>24091FE</b>	2	\$222.00
Foam Cell Pro - Performance			<b>45091FE</b>	2	\$305.00
Foam Cell Pro - Professional			<b>45091FEP</b>	2	\$305.00

#### COIL SPRINGS

	Est. Lift	Additional Load			
Light	40mm	0 - 50kg	<b>TOY046A</b>	1	\$250.00
Medium	50mm	0 - 50kg	<b>TOY046B</b>	1	\$250.00
Heavy	50mm	50 - 110kg	<b>TOY046C</b>	1	\$250.00
Medium - 4" Lift	100mm	0 - 50kg	<b>TOY079B</b>	1	\$250.00

#### STEERING DAMPER

Foam Cell	1999-2006	<b>3524</b>	1	\$167.00
Foam Cell	2007+	<b>3525</b>	1	\$167.00

#### CASTER CORRECTION

2° Offset Bush Kit - Polyurethane		<b>1144SK</b>	1	\$153.00
Adjustable Offset STD, 2.5, 3.5 Degree - Polyurethane		<b>1144</b>	1	\$153.00
2° Offset Bush Kit - Rubber		<b>1144RK</b>	1	\$153.00

#### STEERING RODS

Adjustable Drag Link	2007+ Wide Body Model Only	<b>ADL070</b>	1	\$416.00
Adjustable Track Rod	2007+ Wide Body Model Only	<b>ATR070</b>	1	\$416.00

#### PANHARD ROD

Adjustable Panhard Rod	2007+ RHD Only	<b>PANHARD013</b>	1	\$319.00
Adjustable Panhard Rod	2007+ LHD Only	<b>PANHARD013L</b>	1	\$319.00

#### SWAY BAR

33mm Sway Bar	Narrow Body 1999-2007	<b>ISB789F</b>	1	\$582.00
33mm Sway Bar	Petrol Engines 2007+	<b>ISB789FWP</b>	1	\$582.00
33mm Sway Bar	Diesel Engines 2007+	<b>ISB789FW</b>	1	\$582.00

#### SWAY BAR LINK

Extended Sway Bar Link		<b>SBEXT001</b>	2	\$28.00
------------------------	--	-----------------	---	---------

#### COIL SPACER

Polyurethane 30mm		<b>LC70F30</b>	2	\$42.00
-------------------	--	----------------	---	---------

### REAR SUSPENSION

#### SHOCK ABSORBER

Nitro Gas - Comfort			<b>12094GRC</b>	2	\$153.00
Nitro Gas - Performance			<b>12094GR</b>	2	\$153.00
Foam Cell - Comfort			<b>24094FEC</b>	2	\$222.00
Foam Cell - Performance			<b>24094FE</b>	2	\$222.00
Foam Cell - Professional			<b>24094FEP</b>	2	\$222.00
Foam Cell - Extra Long - Comfort			<b>24094LFEC</b>	2	\$250.00
Foam Cell - Extra Long - Performance			<b>24094LFE</b>	2	\$250.00
Foam Cell - Extra Long - Professional			<b>24094LFEP</b>	2	\$250.00
Foam Cell Pro - Comfort			<b>45094FEC</b>	2	\$305.00
Foam Cell Pro - Performance			<b>45094FE</b>	2	\$305.00
Foam Cell Pro - Professional			<b>45094FEP</b>	2	\$305.00
Foam Cell Pro - Extra Long - Comfort			<b>45094LFEC</b>	2	\$319.00
Foam Cell Pro - Extra Long - Performance			<b>45094LFE</b>	2	\$319.00
Foam Cell Pro - Extra Long - Professional			<b>45094LFEP</b>	2	\$319.00

#### LEAF SPRINGS

	Est. Lift	Additional Load			
Light	50mm	0 - 150kg	<b>TOY047A</b>	2	\$582.00
Medium	50mm	0 - 250kg	<b>TOY047B</b>	2	\$624.00
Heavy	50mm	250 - 400kg	<b>TOY047C</b>	2	\$652.00
Extra Heavy	50mm	400kg - 600kg	<b>TOY047D</b>	2	\$693.00
Super Heavy	50mm	600kg - GVM	<b>TOY047E</b>	2	\$707.00

LISTING  
CONTINUED  
OVER THE  
PAGE



# Toyota Landcruiser

**Product Description**

**Part No.**

**Qty  
Req**

**Retail  
ea Inc GST**

**U-BOLTS**

U-Bolt Kit		<b>416UBK</b>	2	\$42.00
U-Bolt Kit Extra Long	Suit TOY047D and TOY047E Spring	<b>416UBKL</b>	2	\$42.00

**POLYURETHANE SPRING BUSHES**

Bush Kit		<b>1085UK</b>	1	\$84.00
----------	--	---------------	---	---------

**SWAY BAR**

30mm Sway Bar (Includes Mounting Brackets)	2007+ Only	<b>ISB789RW</b>	1	\$582.00
--	------------	-----------------	---	----------

**GREASABLE SHACKLES AND PINS**

Greasable Shackle		<b>1141</b>	2	\$70.00
Greasable Pin		<b>1142</b>	2	\$42.00

**HELPER SPRINGS**

Load Plus Helper Springs	Drum Brake Models Only	<b>LP9</b>	1	\$223.00
--------------------------	------------------------	------------	---	----------

**SUSPENSION KIT**

Light - Nitro Gas		<b>TOY046AKG1</b>		\$2189.00
Light - Foam Cell		<b>TOY046AKF1</b>		\$2466.00
Light - Foam Cell Pro		<b>TOY046AKP1</b>		\$2799.00
Medium - Nitro Gas		<b>TOY046BKG1</b>		\$2272.00
Medium - Foam Cell		<b>TOY046BKF1</b>		\$2549.00
Medium - Foam Cell Pro		<b>TOY046BKP1</b>		\$2882.00
Heavy - Nitro Gas		<b>TOY046CKG1</b>		\$2328.00
Heavy - Foam Cell		<b>TOY046CKF1</b>		\$2605.00
Heavy - Foam Cell Pro		<b>TOY046CKP1</b>		\$2937.00
Extra Heavy - Nitro Gas		<b>TOY046DKG1</b>		\$2411.00
Extra Heavy - Foam Cell		<b>TOY046DKF1</b>		\$2743.00
Extra Heavy - Foam Cell Pro		<b>TOY046DKP1</b>		\$3048.00
Super Heavy - Foam Cell		<b>TOY046EKF1</b>		\$2771.00
Super Heavy - Foam Cell Pro		<b>TOY046EKP1</b>		\$3076.00

• Specify front Coil Springs when ordering

**SUSPENSION KIT CONTENTS**

Shock Absorbers	Leaf Springs	Polyurethane Spring Bushes
Coil Springs	U-Bolts	



**OPTIONS AVAILABLE FOR THIS VEHICLE 2007+ ONLY - SEE PAGE 388**





79 Series Dual Cab  
11/2012+

# Toyota Landcruiser

Product Description

Part No.

Qty  
ReqRetail  
ea Inc GST

## ACCESSORIES TO SUIT TOYOTA LANDCRUISER

### STEEL WINCH BULL BARS (NO SIDE PLATES ON BAR)

Commercial	BBC019E	\$1648.00
Premium - 60.3mm Tube	BBP019E	\$2098.00

### STEEL SIDE STEPS AND RAILS

Side Steps	SS019	\$962.00
Side Steps and Rails	SSR019	\$1155.00
Premium Side Steps and Rails - 60.3mm Tube	SSRP019	\$1276.00

### RECOVERY POINTS - IRONMAN 4X4 BULL BAR ONLY

Recovery Points - 5000kg Rating (Pair)	IRP019	\$234.00
--	--------	----------

### SNORKEL

Landcruiser 79 Series V8	ISNORKEL023	\$418.00
--------------------------	-------------	----------

### EXHAUST SYSTEM

BigBore Landcruiser 70 Series 11/2012 to 8/2016 4.5L V8 Turbo Diesel* - <i>While Stocks Last</i> <i>*Does not suit vehicle with DPF.</i>	IEXHAUST013	\$1360.00
---	-------------	-----------

### EXHAUST SYSTEM

3" Exhaust Upgrade 4.5L V8 - DPF Back (12/2016+) - <i>While Stocks Last</i>	IEX019DPF	\$810.00
---	-----------	----------

### PREMIUM UNDERBODY PROTECTION

Radiator and Steering Rods	UBP019	\$290.00
----------------------------	--------	----------

### STEEL ROOF RACKS

Cage Style - 1.4m x 1.25m	IRRCAGE14	\$777.00
Cage Style - 1.8m x 1.25m	IRRCAGE18	\$815.00
Rooftop Tent Compatible - 1.8m x 1.25m	IRRTENT18	\$777.00
Trade Style - 1.8m x 1.25m (Open end)	IRRTRADE18	\$777.00

### ALLOY ROOF RACKS

Cage Style - 1.4m x 1.25m	IRRCAGE14-ALLOY	\$983.00
Cage Style - 1.8m x 1.25m	IRRCAGE18-ALLOY	\$1149.00
Trade Style - 1.4m x 1.25m (Open end)	IRROPEN14-ALLOY	\$971.00
Trade Style - 1.8m x 1.25m (Open end)	IRRTRADE18-ALLOY	\$1132.00
Flat Rack - 1.8m x 1.25m	IRRTFLAT18-ALLOY	\$1116.00

### ROOF RACK - MOUNTING KITS

Gutter Mount Feet - 125mm (8 Feet)	IRRFEET125	\$198.00
------------------------------------	------------	----------

### SEAT COVER

Canvas Comfort - Front Bucket Pair	ICSC019F	\$401.00
Canvas Comfort - Front Bucket and 3/4 Bench	ICSC019F3/4	\$401.00
Canvas Comfort - Rear	ICSC019R	\$401.00

### DIFF BREATHER KIT

Diff Breather Kit	IDIFFBRE	\$115.00
-------------------	----------	----------

LISTING  
CONTINUED  
OVER THE  
PAGE



Product Description

Part No.

Qty  
Req

Retail  
ea Inc GST

## SUSPENSION TO SUIT TOYOTA LANDCRUISER

### FRONT SUSPENSION

#### SHOCK ABSORBER

Nitro Gas - Performance			<b>12091GR</b>	2	\$153.00
Foam Cell - Performance			<b>24091FE</b>	2	\$222.00
Foam Cell Pro - Performance			<b>45091FE</b>	2	\$305.00
Foam Cell Pro - Professional			<b>45091FEP</b>	2	\$305.00

#### COIL SPRINGS

	Est. Lift	Additional Load			
Light	40mm	0 - 50kg	<b>TOY046A</b>	1	\$250.00
Medium	50mm	0 - 50kg	<b>TOY046B</b>	1	\$250.00
Medium - 4" Lift	100mm	0 - 50kg	<b>TOY079B</b>	1	\$250.00
Heavy	50mm	50 - 110kg	<b>TOY046C</b>	1	\$250.00

#### STEERING DAMPER

Foam Cell			<b>3525</b>	1	\$167.00
-----------	--	--	-------------	---	----------

#### CASTER CORRECTION

2° Offset Bush Kit - Polyurethane			<b>1144SK</b>	1	\$153.00
Adjustable Offset STD, 2.5, 3.5 Degree - Polyurethane			<b>1144</b>	1	\$153.00
2° Offset Bush Kit - Rubber			<b>1144RK</b>	1	\$153.00

#### STEERING RODS

Adjustable Drag Link	2007+ Wide Body Model Only		<b>ADL070</b>	1	\$416.00
Adjustable Track Rod	2007+ Wide Body Model Only		<b>ATR070</b>	1	\$416.00

#### PANHARD ROD

Adjustable Panhard Rod	RHD Only		<b>PANHARD013</b>	1	\$319.00
Adjustable Panhard Rod	2007+ LHD Only		<b>PANHARD013L</b>	1	\$319.00

#### SWAY BAR

33mm Sway Bar	Petrol Engines		<b>ISB789FWP</b>	1	\$582.00
33mm Sway Bar	Diesel Engines		<b>ISB789FW</b>	1	\$582.00

#### SWAY BAR LINK

Extended Sway Bar Link			<b>SBEXT001</b>	2	\$28.00
------------------------	--	--	-----------------	---	---------

#### COIL SPACER

Polyurethane 30mm			<b>LC70F30</b>	2	\$42.00
-------------------	--	--	----------------	---	---------





79 Series Dual Cab  
2013+

# Toyota Landcruiser

Product Description	Part No.	Qty Req	Retail ea Inc GST
<b>REAR SUSPENSION</b>			
<b>SHOCK ABSORBER</b>			
Nitro Gas - Comfort	12094GRC	2	\$153.00
Nitro Gas - Performance	12094GR	2	\$153.00
Foam Cell - Comfort	24094FEC	2	\$222.00
Foam Cell - Performance	24094FE	2	\$222.00
Foam Cell - Professional	24094FEP	2	\$222.00
Foam Cell - Extra Long - Comfort	24094LFEC	2	\$250.00
Foam Cell - Extra Long - Performance	24094LFE	2	\$250.00
Foam Cell - Extra Long - Professional	24094LFEP	2	\$250.00
Foam Cell Pro - Comfort	45094FEC	2	\$305.00
Foam Cell Pro - Performance	45094FE	2	\$305.00
Foam Cell Pro - Professional	45094FEP	2	\$305.00
Foam Cell Pro - Extra Long - Comfort	45094LFEC	2	\$319.00
Foam Cell Pro - Extra Long - Performance	45094LFE	2	\$319.00
Foam Cell Pro - Extra Long - Professional	45094LFEP	2	\$319.00
<b>LEAF SPRINGS</b>	<b>Est. Lift</b>	<b>Additional Load</b>	
Light	50mm	0 - 250kg	TOY047B 2 \$624.00
Medium	50mm	0 - 300kg	TOY047C 2 \$652.00
Heavy	50mm	300kg - 500kg	TOY047D 2 \$693.00
Extra Heavy	50mm	500kg - GVM	TOY047E 2 \$707.00
<b>U-BOLTS</b>			
U-Bolt Kit			416UBK 2 \$42.00
U-Bolt Kit Extra Long	Suit TOY047D and TOY047E Spring		416UBKL 2 \$42.00
<b>POLYURETHANE SPRING BUSHES</b>			
Bush Kit			1085UK 1 \$84.00
<b>SWAY BAR</b>			
30mm Sway Bar	Includes Mounting Brackets		ISB789RW 1 \$582.00
<b>GREASABLE SHACKLES AND PINS</b>			
Greasable Shackle			1141 2 \$70.00
Greasable Pin			1142 2 \$42.00
<b>HELPER SPRINGS</b>			
Load Plus Helper Springs	Drum Brake Models Only		LP9 1 \$223.00

<b>SUSPENSION KIT</b>			
Light - Nitro Gas	TOY046BKG1		\$2272.00
Light - Foam Cell	TOY046BKF1		\$2549.00
Light - Foam Cell Pro	TOY046BKP1		\$2882.00
Medium - Nitro Gas	TOY046CKG1		\$2328.00
Medium - Foam Cell	TOY046CKF1		\$2605.00
Medium - Foam Cell Pro	TOY046CKP1		\$2937.00
Heavy - Nitro Gas	TOY046DKG1		\$2411.00
Heavy - Foam Cell	TOY046DKF1		\$2743.00
Heavy - Foam Cell Pro	TOY046DKP1		\$3048.00
Extra Heavy - Foam Cell	TOY046EKF1		\$2771.00
Extra Heavy - Foam Cell Pro	TOY046EKP1		\$3076.00

• Specify front Coil Springs when ordering

<b>SUSPENSION KIT CONTENTS</b>			
Shock Absorbers	Leaf Springs	Polyurethane Spring Bushes	
Coil Springs	U-Bolts		



OPTIONS AVAILABLE FOR THIS VEHICLE 2012+ ONLY - SEE PAGE 389





You have entered Cruiser country!



for a full range of accessories visit our website

[www.ironman4x4.com](http://www.ironman4x4.com)







78 Series Troop Carrier  
2007+

# Toyota Landcruiser

Product Description	Part No.	Qty Req	Retail ea Inc GST
---------------------	----------	------------	----------------------

## ACCESSORIES TO SUIT TOYOTA LANDCRUISER

<b>STEEL WINCH BULL BARS (NO SIDE PLATES ON BAR)</b>			
Commercial	BBC019E		\$1648.00
Premium - 60.3mm Tube	BBP019E		\$2098.00
<b>LOCKS SAFE DRAWER SYSTEMS</b>			
Twin Drawers - 1300mm	ITD1300		\$1469.00
Single Drawer - 1300mm	ISD1300		\$891.00
Wing Kit - 1300mm (GXL 2008+)	ITDW022		\$351.00
<b>RECOVERY POINTS - IRONMAN 4X4 BULL BAR ONLY</b>			
Recovery Points - 5000kg Rating (Pair)	IRP019		\$234.00
<b>SNORKEL</b>			
Landcruiser 78 Series V8 2007+	ISNORKEL023		\$418.00
<b>EXHAUST SYSTEM</b>			
BigBore Landcruiser 78 Series 2007 to 8/2016 4.5L V8 Turbo Diesel* - <i>While Stocks Last</i> <i>*Does not suit vehicle with DPF</i>	IEXHAUST009		\$1360.00
<b>PREMIUM UNDERBODY PROTECTION</b>			
Radiator and Steering Rods	UBP019		\$290.00
<b>STEEL ROOF RACKS</b>			
Cage Style - 1.4m x 1.25m	IRRCAGE14		\$777.00
Cage Style - 1.8m x 1.25m	IRRCAGE18		\$815.00
Cage Style - 2.2m x 1.25m	IRRCAGE22		\$846.00
Rooftop Tent Compatible - 1.8m x 1.25m	IRRTENT18		\$777.00
Rooftop Tent Compatible - 2.2m x 1.25m	IRRTENT22		\$815.00
Trade Style - 1.8m x 1.25m (Open end)	IRRTRADE18		\$777.00
Trade Style - 2.2m x 1.25m (Open end)	IRRTRADE22		\$809.00
<b>ALLOY ROOF RACKS</b>			
Cage Style - 1.4m x 1.25m	IRRCAGE14-ALLOY		\$983.00
Cage Style - 1.8m x 1.25m	IRRCAGE18-ALLOY		\$1149.00
Cage Style - 2.2m x 1.25m	IRRCAGE22-ALLOY		\$1212.00
Trade Style - 1.4m x 1.25m (Open end)	IRROPEN14-ALLOY		\$971.00
Trade Style - 1.8m x 1.25m (Open end)	IRRTRADE18-ALLOY		\$1132.00
Trade Style - 2.2m x 1.25m (Open end)	IRRTRADE22-ALLOY		\$1181.00
Flat Rack - 1.8m x 1.25m	IRRTFLAT18-ALLOY		\$1116.00
<b>ROOF RACK - MOUNTING KITS</b>			
Gutter Mount Feet - 210mm (8 Feet)	IRRFEET210		\$218.00
<b>SEAT COVER</b>			
Canvas Comfort - Front Bucket Pair	ICSC019F		\$401.00
Canvas Comfort - Front Bucket and 3/4 Bench	ICSC019F3/4		\$401.00
<b>DIFF BREATHER KIT</b>			
Diff Breather Kit	IDIFFBRE		\$115.00

LISTING  
CONTINUED  
OVER THE  
PAGE





Product Description

Part No.

Qty  
Req

Retail  
ea Inc GST

## SUSPENSION TO SUIT TOYOTA LANDCRUISER

### FRONT SUSPENSION

#### SHOCK ABSORBER

Nitro Gas - Performance			<b>12091GR</b>	2	\$153.00
Foam Cell - Performance			<b>24091FE</b>	2	\$222.00
Foam Cell Pro - Performance			<b>45091FE</b>	2	\$305.00
Foam Cell Pro - Professional			<b>45091FEP</b>	2	\$305.00

#### COIL SPRINGS

	Est. Lift	Additional Load			
Light	40mm	0 - 50kg	<b>TOY046A</b>	1	\$250.00
Medium	50mm	0 - 50kg	<b>TOY046B</b>	1	\$250.00
Medium - 4" Lift	100mm	0 - 50kg	<b>TOY079B</b>	1	\$250.00
Heavy	50mm	50 - 110kg	<b>TOY046C</b>	1	\$250.00

#### STEERING DAMPER

Foam Cell	2007+		<b>3525</b>	1	\$167.00
-----------	-------	--	-------------	---	----------

#### CASTER CORRECTION

2° Offset Bush Kit - Polyurethane			<b>1144SK</b>	1	\$153.00
Adjustable Offset STD, 2.5, 3.5 Degree - Polyurethane			<b>1144</b>	1	\$153.00
2° Offset Bush Kit - Rubber			<b>1144RK</b>	1	\$153.00

#### STEERING RODS

Adjustable Drag Link	2007+ Wide Body Model Only		<b>ADL070</b>	1	\$416.00
Adjustable Track Rod	2007+ Wide Body Model Only		<b>ATRO70</b>	1	\$416.00

#### PANHARD ROD

Adjustable Panhard Rod	2007+ RHD Only		<b>PANHARD013</b>	1	\$319.00
Adjustable Panhard Rod	2007+ LHD Only		<b>PANHARD013L</b>	1	\$319.00

#### SWAY BAR

33mm Sway Bar	Narrow Body 1999-2007		<b>ISB789F</b>	1	\$582.00
33mm Sway Bar	Petrol Engines 2007+		<b>ISB789FWP</b>	1	\$582.00
33mm Sway Bar	Diesel Engines 2007+		<b>ISB789FW</b>	1	\$582.00

#### SWAY BAR LINK

Extended Sway Bar Link			<b>SBEXT001</b>	2	\$28.00
------------------------	--	--	-----------------	---	---------

#### COIL SPACER

Polyurethane 30mm			<b>LC70F30</b>	2	\$42.00
-------------------	--	--	----------------	---	---------







78 Series  
2007+

# Toyota Landcruiser

Product Description	Part No.	Qty Req	Retail ea Inc GST
<b>REAR SUSPENSION</b>			
<b>SHOCK ABSORBER</b>			
Nitro Gas - Comfort	12094GRC	2	\$153.00
Nitro Gas - Performance	12094GR	2	\$153.00
Foam Cell - Comfort	24094FEC	2	\$222.00
Foam Cell - Performance	24094FE	2	\$222.00
Foam Cell - Professional	24094FEP	2	\$222.00
Foam Cell - Extra Long - Comfort	24094LFEC	2	\$250.00
Foam Cell - Extra Long - Performance	24094LFE	2	\$250.00
Foam Cell - Extra Long - Professional	24094LFEP	2	\$250.00
Foam Cell Pro - Comfort	45094FEC	2	\$305.00
Foam Cell Pro - Performance	45094FE	2	\$305.00
Foam Cell Pro - Professional	45094FEP	2	\$305.00
Foam Cell Pro - Extra Long - Comfort	45094LFEC	2	\$319.00
Foam Cell Pro - Extra Long - Performance	45094LFE	2	\$319.00
Foam Cell Pro - Extra Long - Professional	45094LFEP	2	\$319.00
<b>LEAF SPRINGS</b>	<b>Est. Lift</b>	<b>Additional Load</b>	
Light	50mm	0 - 150kg	TOY047A 2 \$582.00
Medium	50mm	0 - 250kg	TOY047B 2 \$624.00
Heavy	50mm	250 - 400kg	TOY047C 2 \$652.00
Extra Heavy	50mm	400kg - 600kg	TOY047D 2 \$693.00
Super Heavy	50mm	600kg - GVM	TOY047E 2 \$707.00
<b>U-BOLTS</b>			
U-Bolt Kit			416UBK 2 \$42.00
U-Bolt Kit Extra Long	Suit TOY047D and TOY047E Spring		416UBKL 2 \$42.00
<b>POLYURETHANE SPRING BUSHES</b>			
Bush Kit			1084UK 1 \$84.00
<b>SWAY BAR</b>			
30mm Sway Bar (Includes Mounting Brackets)	2007+ Only		ISB789RW 1 \$582.00
<b>GREASABLE SHACKLES AND PINS</b>			
Greasable Shackle			1141 2 \$70.00
Greasable Pin			1142 2 \$42.00
<b>HELPER SPRINGS</b>			
Load Plus Helper Springs	Drum Brake Models Only		LP9 1 \$223.00

<b>SUSPENSION KIT</b>			
Light - Nitro Gas	TOY046AKG		\$2189.00
Light - Foam Cell	TOY046AKF		\$2466.00
Light - Foam Cell Pro	TOY046AKP		\$2799.00
Medium - Nitro Gas	TOY046BKG		\$2272.00
Medium - Foam Cell	TOY046BKF		\$2549.00
Medium - Foam Cell Pro	TOY046BKP		\$2882.00
Heavy - Nitro Gas	TOY046CKG		\$2328.00
Heavy - Foam Cell	TOY046CKF		\$2605.00
Heavy - Foam Cell Pro	TOY046CKP		\$2937.00
Extra Heavy - Nitro Gas	TOY046DKG		\$2411.00
Extra Heavy - Foam Cell	TOY046DKF		\$2743.00
Extra Heavy - Foam Cell Pro	TOY046DKP		\$3048.00
Super Heavy - Foam Cell	TOY046EKF		\$2771.00
Super Heavy - Foam Cell Pro	TOY046EKP		\$3076.00

• Specify front Coil Springs when ordering

<b>SUSPENSION KIT CONTENTS</b>		
Shock Absorbers	Leaf Springs	Polyurethane Spring Bushes
Coil Springs	U-Bolts	



OPTIONS AVAILABLE FOR THIS VEHICLE 2007+ ONLY - SEE PAGE 390



# Alu-Cab™

ULTIMATE OVERLAND PRODUCTS

HERCULES 

Roof conversion  
to Suit Landcruiser Troopy



for a full range of alu-cab visit our website

[www.alu-cab.com.au](http://www.alu-cab.com.au)

*distributed by*





78 Series  
1999 to 2007

# Toyota Landcruiser

Product Description

Part No.

Qty  
ReqRetail  
ea Inc GST

## ACCESSORIES TO SUIT TOYOTA LANDCRUISER

### STEEL WINCH BULL BARS (NO SIDE PLATES ON BAR)

Commercial	BBC018	\$1498.00
Commercial Deluxe	BBCD018	\$2244.00

### LOCKSAFE DRAWER SYSTEMS

Twin Drawers - 1300mm Troop Carrier LC78	ITD1300	\$1469.00
Single Drawer - 1300mm	ISD1300	\$891.00

### SNORKEL

Landcruiser 4.2L 1HZ Diesel	ISNORKEL009	\$418.00
-----------------------------	-------------	----------

### STEEL ROOF RACKS

Cage Style - 1.4m x 1.25m	IRRCAGE14	\$777.00
Cage Style - 1.8m x 1.25m	IRRCAGE18	\$815.00
Cage Style - 2.2m x 1.25m	IRRCAGE22	\$846.00
Rooftop Tent Compatible - 1.8m x 1.25m	IRRTENT18	\$777.00
Rooftop Tent Compatible - 2.2m x 1.25m	IRRTENT22	\$815.00
Trade Style - 1.8m x 1.25m (Open end)	IRRTRADE18	\$777.00
Trade Style - 2.2m x 1.25m (Open end)	IRRTRADE22	\$809.00

### ALLOY ROOF RACKS

Cage Style - 1.4m x 1.25m	IRRCAGE14-ALLOY	\$983.00
Cage Style - 1.8m x 1.25m	IRRCAGE18-ALLOY	\$1149.00
Cage Style - 2.2m x 1.25m	IRRCAGE22-ALLOY	\$1212.00
Trade Style - 1.4m x 1.25m (Open end)	IRROPEN14-ALLOY	\$971.00
Trade Style - 1.8m x 1.25m (Open end)	IRRTRADE18-ALLOY	\$1132.00
Trade Style - 2.2m x 1.25m (Open end)	IRRTRADE22-ALLOY	\$1181.00
Flat Rack - 1.8m x 1.25m	IRRTFLAT18-ALLOY	\$1116.00

### ROOF RACK - MOUNTING KITS

Gutter Mount Feet - 210mm (8 Feet)	IRRFEET210	\$218.00
------------------------------------	------------	----------

### DIFF BREATHER KIT

Diff Breather Kit	IDIFFBRE	\$115.00
-------------------	----------	----------

LISTING  
CONTINUED  
OVER THE  
PAGE





Product Description

Part No.

Qty  
Req

Retail  
ea Inc GST

## SUSPENSION TO SUIT TOYOTA LANDCRUISER

### FRONT SUSPENSION

#### SHOCK ABSORBER

Nitro Gas - Performance			<b>12091GR</b>	2	\$153.00
Foam Cell - Performance			<b>24091FE</b>	2	\$222.00
Foam Cell Pro - Performance			<b>45091FE</b>	2	\$305.00
Foam Cell Pro - Professional			<b>45091FEP</b>	2	\$305.00

#### COIL SPRINGS

	Est. Lift	Additional Load			
Light	40mm	0 - 50kg	<b>TOY046A</b>	1	\$250.00
Medium	50mm	0 - 50kg	<b>TOY046B</b>	1	\$250.00
Medium - 4" Lift	100mm	0 - 50kg	<b>TOY079B</b>	1	\$250.00
Heavy	50mm	50 - 110kg	<b>TOY046C</b>	1	\$250.00

#### STEERING DAMPER

Foam Cell	1999-2006		<b>3524</b>	1	\$167.00
Foam Cell	2007+		<b>3525</b>	1	\$167.00

#### CASTER CORRECTION

2° Offset Bush Kit - Polyurethane			<b>1144SK</b>	1	\$153.00
Adjustable Offset STD, 2.5, 3.5 Degree - Polyurethane			<b>1144</b>	1	\$153.00
2° Offset Bush Kit - Rubber			<b>1144RK</b>	1	\$153.00

#### PANHARD ROD

Adjustable Panhard Rod	2007+ RHD Only		<b>PANHARD013</b>	1	\$319.00
Adjustable Panhard Rod	2007+ LHD Only		<b>PANHARD013L</b>	1	\$319.00

#### SWAY BAR

33mm Sway Bar	Narrow Body 1999-2007		<b>ISB789F</b>	1	\$582.00
33mm Sway Bar	Petrol Engines 2007+		<b>ISB789FWP</b>	1	\$582.00
33mm Sway Bar	Diesel Engines 2007+		<b>ISB789FW</b>	1	\$582.00

#### SWAY BAR LINK

Extended Sway Bar Link			<b>SBEXT001</b>	2	\$28.00
------------------------	--	--	-----------------	---	---------

#### COIL SPACER

Polyurethane 30mm			<b>LC70F30</b>	2	\$42.00
-------------------	--	--	----------------	---	---------





78 Series  
1999 to 2007

**SUSPENSION TO SUIT**

# Toyota Landcruiser

## Product Description

## Part No.

## Qty Req

## Retail ea Inc GST

### REAR SUSPENSION

#### SHOCK ABSORBER

Nitro Gas - Comfort			<b>12094GRC</b>	2	\$153.00
Nitro Gas - Performance			<b>12094GR</b>	2	\$153.00
Foam Cell - Comfort			<b>24094FEC</b>	2	\$222.00
Foam Cell - Performance			<b>24094FE</b>	2	\$222.00
Foam Cell - Professional			<b>24094FEP</b>	2	\$222.00
Foam Cell - Extra Long - Comfort			<b>24094LFEC</b>	2	\$250.00
Foam Cell - Extra Long - Performance			<b>24094LFE</b>	2	\$250.00
Foam Cell - Extra Long - Professional			<b>24094LFEP</b>	2	\$250.00
Foam Cell Pro - Comfort			<b>45094FEC</b>	2	\$305.00
Foam Cell Pro - Performance			<b>45094FE</b>	2	\$305.00
Foam Cell Pro - Professional			<b>45094FEP</b>	2	\$305.00
Foam Cell Pro - Extra Long - Comfort			<b>45094LFEC</b>	2	\$319.00
Foam Cell Pro - Extra Long - Performance			<b>45094LFE</b>	2	\$319.00
Foam Cell Pro - Extra Long - Professional			<b>45094LFEP</b>	2	\$319.00

#### LEAF SPRINGS

	Est. Lift	Additional Load			
Light	50mm	0 - 150kg	<b>TOY047A</b>	2	\$582.00
Medium	50mm	0 - 250kg	<b>TOY047B</b>	2	\$624.00
Heavy	50mm	250 - 400kg	<b>TOY047C</b>	2	\$652.00
Extra Heavy	50mm	400kg - 600kg	<b>TOY047D</b>	2	\$693.00
Super Heavy	50mm	600kg - GVM	<b>TOY047E</b>	2	\$707.00

#### U-BOLTS

U-Bolt Kit			<b>416UBK</b>	2	\$42.00
U-Bolt Kit Extra Long	Suit TOY047D and TOY047E Spring		<b>416UBKL</b>	2	\$42.00

#### POLYURETHANE SPRING BUSHES

Bush Kit			<b>1084UK</b>	1	\$84.00
----------	--	--	---------------	---	---------

#### SWAY BAR

30mm Sway Bar (Includes Mounting Brackets)	2007+ Only		<b>ISB789RW</b>	1	\$582.00
--	------------	--	-----------------	---	----------

#### GREASABLE SHACKLES AND PINS

Greasable Shackle			<b>1141</b>	2	\$70.00
Greasable Pin			<b>1142</b>	2	\$42.00

#### HELPER SPRINGS

Load Plus Helper Springs	Drum Brake Models Only		<b>LP9</b>	1	\$223.00
--------------------------	------------------------	--	------------	---	----------

### SUSPENSION KIT

Light - Nitro Gas			<b>TOY046AKG</b>		\$2189.00
Light - Foam Cell			<b>TOY046AKF</b>		\$2466.00
Light - Foam Cell Pro			<b>TOY046AKP</b>		\$2799.00
Medium - Nitro Gas			<b>TOY046BKG</b>		\$2272.00
Medium - Foam Cell			<b>TOY046BKF</b>		\$2549.00
Medium - Foam Cell Pro			<b>TOY046BKP</b>		\$2882.00
Heavy - Nitro Gas			<b>TOY046CKG</b>		\$2328.00
Heavy - Foam Cell			<b>TOY046CKF</b>		\$2605.00
Heavy - Foam Cell Pro			<b>TOY046CKP</b>		\$2937.00
Extra Heavy - Nitro Gas			<b>TOY046DKG</b>		\$2411.00
Extra Heavy - Foam Cell			<b>TOY046DKF</b>		\$2743.00
Extra Heavy - Foam Cell Pro			<b>TOY046DKP</b>		\$3048.00
Super Heavy - Foam Cell			<b>TOY046EKF</b>		\$2771.00
Super Heavy - Foam Cell Pro			<b>TOY046EKP</b>		\$3076.00

• Specify front Coil Springs when ordering

### SUSPENSION KIT CONTENTS

Shock Absorbers	Leaf Springs	Polyurethane Spring Bushes
Coil Springs	U-Bolts	



sometimes the best things in life come in fun size



for a full range of accessories visit our website

[www.ironman4x4.com](http://www.ironman4x4.com)





76 Series  
2007+

## Toyota Landcruiser

Product Description

Part No.

Qty  
ReqRetail  
ea Inc GST

## ACCESSORIES TO SUIT TOYOTA LANDCRUISER

**STEEL WINCH BULL BARS (NO SIDE PLATES ON BAR)**

Commercial	BBC019E	\$1648.00
Premium - 60.3mm Tube	BBP019E	\$2098.00

**STEEL SIDE STEPS AND RAILS**

Side Steps	SS015	\$962.00
Side Steps and Rails	SSR015	\$1155.00
Premium Side Steps and Rails - 60.3mm Tube	SSRP015	\$1276.00

**LOCKSAFE DRAWER SYSTEMS**

Twin Drawers - 900mm	ITD900	\$1242.00
Single Drawer - 900mm	ISD900	\$767.00
Wing Kit - 900mm (76 Series GXL)	ITDW009	\$270.00

**RECOVERY POINTS - IRONMAN 4X4 BULL BAR ONLY**

Recovery Points - 5000kg Rating (Pair)	IRP019	\$234.00
--	--------	----------

**SNORKEL**

Landcruiser V8 2007+	ISNORKEL023	\$418.00
----------------------	-------------	----------

**EXHAUST SYSTEM**

BigBore Landcruiser 76 Series 2007 to 8/2016, 4.5L V8 Turbo Diesel* - <i>While Stocks Last</i> <i>*Does not suit vehicle with DPF</i>	IEXHAUST002	\$1360.00
--	-------------	-----------

**PREMIUM UNDERBODY PROTECTION**

Radiator and Steering Rods	UBP019	\$290.00
----------------------------	--------	----------

**LONG RANGE FUEL TANK**

160L* Diesel - 76 Series up to 11/2012 only <i>* Usable volume may differ to the stated tank capacity</i>	TANK001	\$1129.00
--	---------	-----------

**STEEL ROOF RACKS**

Cage Style - 1.4m x 1.25m	IRRCAGE14	\$777.00
Cage Style - 1.8m x 1.25m	IRRCAGE18	\$815.00
Cage Style - 2.2m x 1.25m	IRRCAGE22	\$846.00
Rooftop Tent Compatible - 1.8m x 1.25m	IRRTENT18	\$777.00
Rooftop Tent Compatible - 2.2m x 1.25m	IRRTENT22	\$815.00
Trade Style - 1.8m x 1.25m (Open end)	IRRTADE18	\$777.00
Trade Style - 2.2m x 1.25m (Open end)	IRRTADE22	\$809.00

**ALLOY ROOF RACKS**

Cage Style - 1.4m x 1.25m	IRRCAGE14-ALLOY	\$983.00
Cage Style - 1.8m x 1.25m	IRRCAGE18-ALLOY	\$1149.00
Cage Style - 2.2m x 1.25m	IRRCAGE22-ALLOY	\$1212.00
Trade Style - 1.8m x 1.25m (Open end)	IRRTADE18-ALLOY	\$1132.00
Trade Style - 2.2m x 1.25m (Open end)	IRRTADE22-ALLOY	\$1181.00
Flat Rack - 1.8m x 1.25m	IRRTFLAT18-ALLOY	\$1116.00

**ROOF RACK - MOUNTING KITS**

Gutter Mount Feet - 125mm (8 Feet)	IRRFEET125	\$198.00
------------------------------------	------------	----------

**SEAT COVER**

Canvas Comfort - Front Bucket Pair	ICSC019F	\$401.00
Canvas Comfort - Rear	ICSC019R	\$401.00

**DIFF BREATHER KIT**

Diff Breather Kit	IDIFFBRE	\$115.00
-------------------	----------	----------





Product Description

Part No.

Qty  
Req

Retail  
ea Inc GST

## SUSPENSION TO SUIT TOYOTA LANDCRUISER

### FRONT SUSPENSION

#### SHOCK ABSORBER

Nitro Gas - Performance			<b>12091GR</b>	2	\$153.00
Foam Cell - Performance			<b>24091FE</b>	2	\$222.00
Foam Cell Pro - Performance			<b>45091FE</b>	2	\$305.00
Foam Cell Pro - Professional			<b>45091FEP</b>	2	\$305.00

#### COIL SPRINGS

	Est. Lift	Additional Load			
Light	40mm	0 - 50kg	<b>TOY046A</b>	1	\$250.00
Medium	50mm	0 - 50kg	<b>TOY046B</b>	1	\$250.00
Medium - 4" Lift	100mm	0 - 50kg	<b>TOY079B</b>	1	\$250.00
Heavy	50mm	50 - 110kg	<b>TOY046C</b>	1	\$250.00

#### STEERING DAMPER

Foam Cell			<b>3525</b>	1	\$167.00
-----------	--	--	-------------	---	----------

#### CASTER CORRECTION

2° Offset Bush Kit - Polyurethane			<b>1144SK</b>	1	\$153.00
Adjustable Offset STD, 2.5, 3.5 Degree - Polyurethane			<b>1144</b>	1	\$153.00
2° Offset Bush Kit - Rubber			<b>1144RK</b>	1	\$153.00

#### PANHARD ROD

Adjustable Panhard Rod	RHD Only		<b>PANHARD013</b>	1	\$319.00
Adjustable Panhard Rod	2007+ LHD Only		<b>PANHARD013L</b>	1	\$319.00

#### SWAY BAR

33mm Sway Bar	Petrol Engines		<b>ISB789FWP</b>	1	\$582.00
33mm Sway Bar	Diesel Engines		<b>ISB789FW</b>	1	\$582.00

#### SWAY BAR LINK

Extended Sway Bar Link			<b>SBEXT001</b>	2	\$28.00
------------------------	--	--	-----------------	---	---------

#### COIL SPACER

Polyurethane 30mm			<b>LC70F30</b>	2	\$42.00
-------------------	--	--	----------------	---	---------

76 Series  
2007+

## Toyota Landcruiser

## Product Description

## Part No.

Qty  
ReqRetail  
ea Inc GST

## REAR SUSPENSION

## SHOCK ABSORBER

Nitro Gas - Comfort			<b>12094GRC</b>	2	\$153.00
Nitro Gas - Performance			<b>12094GR</b>	2	\$153.00
Foam Cell - Comfort			<b>24094FEC</b>	2	\$222.00
Foam Cell - Performance			<b>24094FE</b>	2	\$222.00
Foam Cell - Professional			<b>24094FEP</b>	2	\$222.00
Foam Cell - Extra Long - Comfort			<b>24094LFEC</b>	2	\$250.00
Foam Cell - Extra Long - Performance			<b>24094LFE</b>	2	\$250.00
Foam Cell - Extra Long - Professional			<b>24094LFEP</b>	2	\$250.00
Foam Cell Pro - Comfort			<b>45094FEC</b>	2	\$305.00
Foam Cell Pro - Performance			<b>45094FE</b>	2	\$305.00
Foam Cell Pro - Professional			<b>45094FEP</b>	2	\$305.00
Foam Cell Pro - Extra Long - Comfort			<b>45094LFEC</b>	2	\$319.00
Foam Cell Pro - Extra Long - Performance			<b>45094LFE</b>	2	\$319.00
Foam Cell Pro - Extra Long - Professional			<b>45094LFEP</b>	2	\$319.00

## LEAF SPRINGS

	Est. Lift	Additional Load			
Medium	50mm	0 - 300kg	<b>TOY062B</b>	2	\$582.00
Heavy	50mm	300 - 600kg	<b>TOY062C</b>	2	\$610.00
Extra Heavy	50mm	600kg - GVM	<b>TOY062D</b>	2	\$624.00

## U-BOLTS

U-Bolt Kit			<b>416UBK</b>	2	\$42.00
------------	--	--	---------------	---	---------

## POLYURETHANE SPRING BUSHES

Bush Kit			<b>1085UK</b>	1	\$84.00
----------	--	--	---------------	---	---------

## GREASABLE SHACKLES AND PINS

Greasable Shackle			<b>1141-1</b>	2	\$70.00
Greasable Shackle Extended 20mm			<b>1141</b>	2	\$70.00
Greasable Pin			<b>1142</b>	2	\$42.00

## SWAY BAR

30mm Sway Bar	Includes Mounting Brackets		<b>ISB789RW</b>	1	\$582.00
---------------	----------------------------	--	-----------------	---	----------

## HELPER SPRINGS

Load Plus Helper Springs			<b>LP4</b>	1	\$157.00
--------------------------	--	--	------------	---	----------

## SUSPENSION KIT

Medium - Nitro Gas		<b>TOY062BKG</b>	\$2189.00
Medium - Foam Cell		<b>TOY062BKF</b>	\$2466.00
Medium - Foam Cell Pro		<b>TOY062BKP</b>	\$2799.00
Heavy - Nitro Gas		<b>TOY062CKG</b>	\$2245.00
Heavy - Foam Cell		<b>TOY062CKF</b>	\$2522.00
Heavy - Foam Cell Pro		<b>TOY062CKP</b>	\$3131.00
Extra Heavy - Nitro Gas		<b>TOY062DKG</b>	\$2272.00
Extra Heavy - Foam Cell		<b>TOY062DKF</b>	\$2549.00
Extra Heavy - Foam Cell Pro		<b>TOY062DKP</b>	\$3159.00

• Specify front Coil Springs when ordering

## SUSPENSION KIT CONTENTS

Shock Absorbers

Coil Springs

Polyurethane Spring Bushes

Leaf Springs

U-Bolts

# Toyota Landcruiser

75 Series  
1984 to 1999



Product Description

Part No.

Qty  
Req

Retail  
ea Inc GST

## ACCESSORIES TO SUIT TOYOTA LANDCRUISER

### STEEL WINCH BULL BARS (NO SIDE PLATES ON BAR)

Commercial	<b>BBC018</b>	\$1498.00
Commercial Deluxe	<b>BBCD018</b>	\$2244.00

### LOCKSAFE DRAWER SYSTEMS

Twin Drawers - 1300mm	<b>ITD1300</b>	\$1469.00
Single Drawer - 1300mm	<b>ISD1300</b>	\$891.00

### SNORKEL

Landcruiser 4.2L 1HZ Diesel	<b>ISNORKEL009</b>	\$418.00
-----------------------------	--------------------	----------

### DIFF BREATHER KIT

Diff Breather Kit	<b>IDIFFBRE</b>	\$115.00
-------------------	-----------------	----------



75 Series  
1984 to 1999

# Toyota Landcruiser

Product Description

Part No.

Qty  
ReqRetail  
ea Inc GST

## SUSPENSION TO SUIT TOYOTA LANDCRUISER

### FRONT SUSPENSION

#### SHOCK ABSORBER

Nitro Gas - Comfort			<b>12637GRC</b>	2	\$153.00
Nitro Gas - Performance			<b>12637GR</b>	2	\$153.00
Foam Cell - Comfort			<b>24637FEC</b>	2	\$222.00
Foam Cell - Performance			<b>24637FE</b>	2	\$222.00
Foam Cell Pro - Comfort			<b>45637FEC</b>	2	\$305.00
Foam Cell Pro - Performance			<b>45637FE</b>	2	\$305.00

#### LEAF SPRINGS

	Est. Lift	Additional Load			
Medium	50mm	0 - 50kg	<b>TOY008B</b>	2	\$375.00
Heavy	50mm	50 - 100kg	<b>TOY008C</b>	2	\$402.00

#### STEERING DAMPER

Foam Cell			<b>3524</b>	1	\$167.00
-----------	--	--	-------------	---	----------

#### U-BOLTS

U-Bolt Kit			<b>436UBK</b>	2	\$42.00
------------	--	--	---------------	---	---------

#### POLYURETHANE SPRING BUSHES

Bush Kit			<b>719UK</b>	1	\$70.00
----------	--	--	--------------	---	---------

#### GREASABLE SHACKLES AND PINS

Greasable Shackle	Left Hand Side		<b>348LH</b>	1	\$70.00
Greasable Shackle	Right Hand Side		<b>348RH</b>	1	\$70.00
Greasable Pin			<b>351</b>	2	\$42.00

### REAR SUSPENSION

#### SHOCK ABSORBER

Nitro Gas - Comfort			<b>12081GRC</b>	2	\$153.00
Nitro Gas - Performance			<b>12081GR</b>	2	\$153.00
Foam Cell - Comfort			<b>24081FEC</b>	2	\$222.00
Foam Cell - Performance			<b>24081FE</b>	2	\$222.00
Foam Cell - Professional			<b>24081FEP</b>	2	\$222.00
Foam Cell Pro - Comfort			<b>45081FEC</b>	2	\$305.00
Foam Cell Pro - Performance			<b>45081FE</b>	2	\$305.00
Foam Cell Pro - Professional			<b>45081FEP</b>	2	\$305.00

#### LEAF SPRINGS

	Est. Lift	Additional Load			
Medium	50mm	0 - 200kg	<b>TOY009B</b>	2	\$527.00
Heavy	50mm	200 - 400kg	<b>TOY009C</b>	2	\$541.00
Extra Heavy	50mm	400 - 600kg	<b>TOY009D</b>	2	\$555.00
Super Heavy	50mm	600kg - GVM	<b>TOY009E</b>	2	\$582.00

#### U-BOLTS

U-Bolt Kit			<b>416UBK</b>	2	\$42.00
------------	--	--	---------------	---	---------

#### POLYURETHANE SPRING BUSHES

Bush Kit			<b>720UK</b>	1	\$70.00
----------	--	--	--------------	---	---------

#### GREASABLE SHACKLES AND PINS

Greasable Shackle	Left Hand Side		<b>353LH</b>	1	\$70.00
Greasable Shackle	Right Hand Side		<b>353RH</b>	1	\$70.00
Greasable Pin			<b>354</b>	2	\$42.00

#### HELPER SPRINGS

Load Plus Helper Springs	Drum Brake Models Only		<b>LP4</b>	1	\$157.00
--------------------------	------------------------	--	------------	---	----------

### SUSPENSION KIT

Medium - Nitro Gas	<b>TOY008BKG</b>	\$2716.00
Medium - Foam Cell	<b>TOY008BKF</b>	\$2993.00
Medium - Foam Cell Pro	<b>TOY008BKP</b>	\$3325.00
Heavy - Nitro Gas	<b>TOY008CKG</b>	\$2743.00
Heavy - Foam Cell	<b>TOY008CKF</b>	\$3020.00
Heavy - Foam Cell Pro	<b>TOY008CKP</b>	\$3353.00
Extra Heavy - Nitro Gas	<b>TOY009DKG</b>	\$2771.00
Extra Heavy - Foam Cell	<b>TOY009DKF</b>	\$3048.00
Extra Heavy - Foam Cell Pro	<b>TOY009DKP</b>	\$3380.00
Super Heavy - Nitro Gas	<b>TOY009EKG</b>	\$2826.00
Super Heavy - Foam Cell	<b>TOY009EKF</b>	\$3103.00
Super Heavy - Foam Cell Pro	<b>TOY009EKP</b>	\$3436.00

• Specify front Coil Springs when ordering

### SUSPENSION KIT CONTENTS

Shock Absorbers

Leaf Springs

U-Bolts

Polyurethane Spring Bushes





# Toyota Landcruiser II

Prado 70, 73, 78 Series  
1990 to 1996



Product Description

Part No.

Qty  
Req

Retail  
ea Inc GST

## SUSPENSION TO SUIT TOYOTA LANDCRUISER II

### FRONT SUSPENSION

#### SHOCK ABSORBER

Nitro Gas - Performance			<b>12696GR</b>	2	\$153.00
Foam Cell - Performance			<b>24696FE</b>	2	\$222.00

#### COIL SPRINGS

	Est. Lift	Additional Load			
Medium	50mm	0 - 50kg	<b>TOY048B</b>	1	\$250.00
Heavy	50mm	50 - 100kg	<b>TOY048C</b>	1	\$231.00

#### STEERING DAMPER

Foam Cell			<b>3524</b>	1	\$167.00
-----------	--	--	-------------	---	----------

### REAR SUSPENSION

#### SHOCK ABSORBER

Nitro Gas - Performance			<b>12697GR</b>	2	\$153.00
Foam Cell - Performance			<b>24697FE</b>	2	\$222.00

#### COIL SPRINGS

	Est. Lift	Additional Load			
Medium - MWB	50mm	0 - 150kg	<b>TOY049B</b>	1	\$250.00
Heavy - LWB	50mm	150 - 300kg	<b>TOY049C</b>	1	\$231.00

### SUSPENSION KIT

Medium - Nitro Gas	<b>TOY048BKG</b>	\$1109.00
Medium - Foam Cell	<b>TOY048BKF</b>	\$1386.00
Heavy - Nitro Gas	<b>TOY048CKG</b>	\$1109.00
Heavy - Foam Cell	<b>TOY048CKF</b>	\$1386.00

• Specify front Coil Springs when ordering

### SUSPENSION KIT CONTENTS

Shock Absorbers

Coil Springs



1984 to 1989

# Toyota Bundera

Product Description

Part No.

Qty  
Req

Retail  
ea Inc GST

## SUSPENSION TO SUIT TOYOTA BUNDERA

### FRONT SUSPENSION

#### SHOCK ABSORBER

Nitro Gas - Performance			<b>12091GR</b>	2	\$153.00
Foam Cell - Performance			<b>24091FE</b>	2	\$222.00

#### COIL SPRINGS

	Est. Lift	Additional Load			
Medium	50mm	0 - 50kg	<b>TOY018B</b>	1	\$250.00

#### STEERING DAMPER

Foam Cell			<b>3524</b>	1	\$167.00
-----------	--	--	-------------	---	----------

### REAR SUSPENSION

#### SHOCK ABSORBER

Nitro Gas - Performance	Left Hand Side		<b>12639GRS</b>	1	\$153.00
Nitro Gas - Performance	Right Hand Side		<b>12650GR</b>	1	\$153.00
Foam Cell - Performance	Left Hand Side		<b>24639FES</b>	1	\$222.00
Foam Cell - Performance	Right Hand Side		<b>24650FE</b>	1	\$222.00

#### COIL SPRINGS

	Est. Lift	Additional Load			
Medium	50mm	0 - 200kg	<b>TOY019B</b>	1	\$250.00

### SUSPENSION KIT

Medium - Nitro Gas	<b>TOY018BKG</b>	\$1109.00
Medium - Foam Cell	<b>TOY018BKF</b>	\$1386.00

### SUSPENSION KIT CONTENTS

Shock Absorbers                      Coil Springs



# Toyota Landcruiser

71 Series (Coil/Leaf)  
1999+



Product Description

Part No.

Qty  
Req

Retail  
ea Inc GST

## SUSPENSION TO SUIT TOYOTA LANDCRUISER

### FRONT SUSPENSION

#### SHOCK ABSORBER

Nitro Gas - Performance			<b>12091GR</b>	2	\$153.00
Foam Cell - Performance			<b>24091FE</b>	2	\$222.00
Foam Cell Pro - Performance			<b>45091FE</b>	2	\$305.00
Foam Cell Pro - Professional			<b>45091FEP</b>	2	\$305.00

#### COIL SPRINGS

	Est. Lift	Additional Load			
Light	40mm	0 - 50kg	<b>TOY046A</b>	1	\$250.00
Medium	50mm	0 - 50kg	<b>TOY046B</b>	1	\$250.00
Heavy	50mm	50 - 110kg	<b>TOY046C</b>	1	\$250.00

#### STEERING DAMPER

Foam Cell			<b>3525</b>	1	\$167.00
-----------	--	--	-------------	---	----------

#### CASTER CORRECTION

2° Offset Bush Kit - Polyurethane			<b>1144SK</b>	1	\$153.00
Adjustable Offset STD, 2.5, 3.5 Degree - Polyurethane			<b>1144</b>	1	\$153.00
2° Offset Bush Kit - Rubber			<b>1144RK</b>	1	\$153.00

#### SWAY BAR LINK

Extended Sway Bar Link			<b>SBEXT001</b>	2	\$28.00
------------------------	--	--	-----------------	---	---------

#### COIL SPACER

Polyurethane 30mm			<b>LC70F30</b>	2	\$42.00
-------------------	--	--	----------------	---	---------

### REAR SUSPENSION

#### SHOCK ABSORBER

Nitro Gas - Comfort			<b>12081GRC</b>	2	\$153.00
Nitro Gas - Performance			<b>12081GR</b>	2	\$153.00
Foam Cell - Comfort			<b>24081FEC</b>	2	\$222.00
Foam Cell - Performance			<b>24081FE</b>	2	\$222.00
Foam Cell - Professional			<b>24081FEP</b>	2	\$222.00
Foam Cell Pro - Comfort			<b>45081FEC</b>	2	\$305.00
Foam Cell Pro - Performance			<b>45081FE</b>	2	\$305.00
Foam Cell Pro - Professional			<b>45081FEP</b>	2	\$305.00

#### LEAF SPRINGS

	Est. Lift	Additional Load			
Light	50mm	0 - 150kg	<b>TOY007AD/S</b>	2	\$375.00
Medium	50mm	0 - 250kg	<b>TOY007BD/S</b>	2	\$375.00
Heavy	50mm	250kg - GVM	<b>TOY007CD/S</b>	2	\$402.00

#### U-BOLTS

U-Bolt Kit			<b>415UBK</b>	2	\$42.00
------------	--	--	---------------	---	---------

#### POLYURETHANE SPRING BUSHES

Bush Kit			<b>1185UK</b>	1	\$84.00
----------	--	--	---------------	---	---------

#### GREASABLE SHACKLES AND PINS

Greasable Shackle			<b>1141-1</b>	2	\$70.00
Greasable Shackle		Extra long	<b>1141</b>	2	\$70.00
Greasable Pin			<b>1142</b>	2	\$42.00

### SUSPENSION KIT

Light - Nitro Gas			<b>TOY058AKG</b>		\$1774.00
Light - Foam Cell			<b>TOY058AKF</b>		\$2051.00
Light - Foam Cell Pro			<b>TOY058AKP</b>		\$2383.00
Medium - Nitro Gas			<b>TOY058BKG</b>		\$1774.00
Medium - Foam Cell			<b>TOY058BKF</b>		\$2051.00
Medium - Foam Cell Pro			<b>TOY058BKP</b>		\$2383.00
Heavy - Nitro Gas			<b>TOY058CKG</b>		\$1829.00
Heavy - Foam Cell			<b>TOY058CKF</b>		\$2106.00
Heavy - Foam Cell Pro			<b>TOY058CKP</b>		\$2438.00

• Specify front Coil Springs when ordering

### SUSPENSION KIT CONTENTS

Shock Absorbers	Coil Springs	U-Bolts	Polyurethane Spring Bushes
Leaf Springs			



70, 73, 74 Series (Leaf/Leaf)  
1984 to 1988

# Toyota Landcruiser

Product Description

Part No.

Qty  
ReqRetail  
ea Inc GST

## SUSPENSION TO SUIT TOYOTA LANDCRUISER

### FRONT SUSPENSION

#### SHOCK ABSORBER

Nitro Gas - Comfort			<b>12637GRC</b>	2	\$153.00
Nitro Gas - Performance			<b>12637GR</b>	2	\$153.00
Foam Cell - Comfort			<b>24637FEC</b>	2	\$222.00
Foam Cell - Performance			<b>24637FE</b>	2	\$222.00
Foam Cell Pro - Comfort			<b>45637FEC</b>	2	\$305.00
Foam Cell Pro - Performance			<b>45637FE</b>	2	\$305.00

#### LEAF SPRINGS

	Est. Lift	Additional Load			
Medium	50mm	0 - 100kg	<b>TOY008B</b>	2	\$375.00

#### STEERING DAMPER

Foam Cell			<b>3524</b>	1	\$167.00
-----------	--	--	-------------	---	----------

#### U-BOLTS

U-Bolt Kit			<b>436UBK</b>	2	\$42.00
------------	--	--	---------------	---	---------

#### POLYURETHANE SPRING BUSHES

Bush Kit			<b>719UK</b>	1	\$70.00
----------	--	--	--------------	---	---------

#### GREASABLE SHACKLES AND PINS

Greasable Shackle	Left Hand Side		<b>348LH</b>	1	\$70.00
Greasable Shackle	Right Hand Side		<b>348RH</b>	1	\$70.00
Greasable Pin			<b>351</b>	2	\$42.00

### REAR SUSPENSION

#### SHOCK ABSORBER

Nitro Gas - Comfort			<b>12650GRC</b>	2	\$153.00
Nitro Gas - Performance			<b>12650GR</b>	2	\$153.00
Foam Cell - Comfort			<b>24650FEC</b>	2	\$222.00
Foam Cell - Performance			<b>24650FE</b>	2	\$222.00
Foam Cell - Professional			<b>24650FEP</b>	2	\$222.00
Foam Cell Pro - Comfort			<b>45650FEC</b>	2	\$305.00
Foam Cell Pro - Performance			<b>45650FE</b>	2	\$305.00
Foam Cell Pro - Professional			<b>45650FEP</b>	2	\$305.00

#### LEAF SPRINGS

	Est. Lift	Additional Load			
Light	50mm	0 - 200kg	<b>TOY007AN/S</b>	2	\$375.00
Medium	50mm	0 - 200kg	<b>TOY007BN/S</b>	2	\$375.00

#### U-BOLTS

U-Bolt Kit			<b>415UBK</b>	2	\$42.00
------------	--	--	---------------	---	---------

#### POLYURETHANE SPRING BUSHES

Bush Kit			<b>719UK</b>	1	\$70.00
----------	--	--	--------------	---	---------

#### GREASABLE SHACKLES AND PINS

Greasable Shackle	Left Hand Side		<b>353LH</b>	1	\$70.00
Greasable Shackle	Right Hand Side		<b>353RH</b>	1	\$70.00
Greasable Pin			<b>354</b>	2	\$42.00

#### HELPER SPRINGS

Load Plus Helper Springs			<b>LP4</b>	1	\$157.00
--------------------------	--	--	------------	---	----------

### SUSPENSION KIT

Light - Nitro Gas		<b>TOY016AKG</b>	\$2411.00
Light - Foam Cell		<b>TOY016AKF</b>	\$2688.00
Light - Foam Cell Pro		<b>TOY016AKP</b>	\$3020.00
Medium - Nitro Gas		<b>TOY016BKG</b>	\$2411.00
Medium - Foam Cell		<b>TOY016BKF</b>	\$2688.00
Medium - Foam Cell Pro		<b>TOY016BKP</b>	\$3020.00

### SUSPENSION KIT CONTENTS

Shock Absorbers

Leaf Springs

U-Bolts

Polyurethane Spring Bushes

# Toyota Landcruiser

60 Series  
11/1980 to 11/1989



Product Description

Part No.

Qty  
Req

Retail  
ea Inc GST

## ACCESSORIES TO SUIT TOYOTA LANDCRUISER

### LOCKSAFE DRAWER SYSTEMS

Twin Drawers - 1000mm	ITD1000		\$1296.00
Single Drawer - 1000mm	ISD1000		\$784.00
Wing Kit - 1000mm	ITDW013		\$270.00

### STEEL ROOF RACKS

Cage Style - 1.4m x 1.25m	IRRCAGE14		\$777.00
Cage Style - 1.8m x 1.25m	IRRCAGE18		\$815.00
Cage Style - 2.2m x 1.25m	IRRCAGE22		\$846.00
Rooftop Tent Compatible - 1.8m x 1.25m	IRRTENT18		\$777.00
Rooftop Tent Compatible - 2.2m x 1.25m	IRRTENT22		\$815.00
Trade Style - 1.8m x 1.25m (Open end)	IRRTRADE18		\$777.00
Trade Style - 2.2m x 1.25m (Open end)	IRRTRADE22		\$809.00

### ALLOY ROOF RACKS

Cage Style - 1.4m x 1.25m	IRRCAGE14-ALLOY		\$983.00
Cage Style - 1.8m x 1.25m	IRRCAGE18-ALLOY		\$1149.00
Cage Style - 2.2m x 1.25m	IRRCAGE22-ALLOY		\$1212.00
Trade Style - 1.4m x 1.25m (Open end)	IRROPEN14-ALLOY		\$971.00
Trade Style - 1.8m x 1.25m (Open end)	IRRTRADE18-ALLOY		\$1132.00
Trade Style - 2.2m x 1.25m (Open end)	IRRTRADE22-ALLOY		\$1181.00
Flat Rack - 1.8m x 1.25m	IRRTFLAT18-ALLOY		\$1116.00

### ROOF RACK - MOUNTING KITS

Gutter Mount Feet - 125mm (8 Feet)	IRRFEET125		\$198.00
------------------------------------	------------	--	----------

### DIFF BREATHER KIT

Diff Breather Kit	IDIFFBRE		\$115.00
-------------------	----------	--	----------

## SUSPENSION TO SUIT TOYOTA LANDCRUISER

### FRONT SUSPENSION

#### SHOCK ABSORBER

Nitro Gas - Comfort	12637GRC	2	\$153.00
Nitro Gas - Performance	12637GR	2	\$153.00
Foam Cell - Comfort	24637FEC	2	\$222.00
Foam Cell - Performance	24637FE	2	\$222.00
Foam Cell Pro - Comfort	45637FEC	2	\$305.00
Foam Cell Pro - Performance	45637FE	2	\$305.00

#### LEAF SPRINGS

	Est. Lift	Additional Load			
Petrol	50mm	0 - 80kg	TOY006B	2	\$375.00
Diesel or Bullbar	50mm	50 - 100kg	TOY006C	2	\$402.00
Turbo Diesel	50mm	50 - 100kg	TOY006D	2	\$402.00

#### STEERING DAMPER

Foam Cell	3524	1	\$167.00
-----------	------	---	----------

#### U-BOLTS

U-Bolt Kit	436UBK	2	\$42.00
------------	--------	---	---------

#### POLYURETHANE SPRING BUSHES

Bush Kit	719UK	1	\$70.00
----------	-------	---	---------

#### GREASABLE SHACKLES AND PINS

Greasable Shackle	Left Hand Side	348LH	1	\$70.00
Greasable Shackle	Right Hand Side	348RH	1	\$70.00
Greasable Pin		351	2	\$42.00





60 Series  
1986+

# Toyota Landcruiser

Product Description	Part No.	Qty Req	Retail ea Inc GST
<b>REAR SUSPENSION</b>			
<b>SHOCK ABSORBER</b>			
Nitro Gas - Comfort	12650GRC	2	\$153.00
Nitro Gas - Performance	12650GR	2	\$153.00
Foam Cell - Comfort	24650FEC	2	\$222.00
Foam Cell - Performance	24650FE	2	\$222.00
Foam Cell - Professional	24650FEP	2	\$222.00
Foam Cell Pro - Comfort	45650FEC	2	\$305.00
Foam Cell Pro - Performance	45650FE	2	\$305.00
Foam Cell Pro - Professional	45650FEP	2	\$305.00
<b>LEAF SPRINGS</b>			
	Est. Lift	Additional Load	
Light - Drivers Side	50mm	0 - 200kg	TOY007AD/S 1 \$375.00
Light - Near Side	50mm	0 - 200kg	TOY007AN/S 1 \$375.00
Medium - Drivers Side	50mm	0 - 200kg	TOY007BD/S 1 \$375.00
Medium - Near Side	50mm	0 - 200kg	TOY007BN/S 1 \$375.00
Heavy - Drivers Side	50mm	200kg - GVM	TOY007CD/S 1 \$402.00
Heavy - Near Side	50mm	200kg - GVM	TOY007CN/S 1 \$402.00
• Side hinge barn door models may require (D/S-D/S) or (N/S-N/S) rear spring configuration to maintain level			
<b>U-BOLTS</b>			
U-Bolt Kit	415UBK	2	\$42.00
<b>POLYURETHANE SPRING BUSHES</b>			
Bush Kit	719UK	1	\$70.00
<b>GREASABLE SHACKLES AND PINS</b>			
Greasable Shackle	Left Hand Side	353LH	1 \$70.00
Greasable Shackle	Right Hand Side	353RH	1 \$70.00
Greasable Pin		351	2 \$42.00
<b>HELPER SPRINGS</b>			
Load Plus Helper Springs	LP4	1	\$157.00

## SUSPENSION KIT

Light - Nitro Gas	Petrol	TOY006AKG3	\$2411.00
Light - Foam Cell	Petrol	TOY006AKF3	\$2688.00
Light - Foam Cell Pro	Petrol	TOY006AKP3	\$3020.00
Light - Nitro Gas	Diesel	TOY006AKG2	\$2466.00
Light - Foam Cell	Diesel	TOY006AKF2	\$2743.00
Light - Foam Cell Pro	Diesel	TOY006AKP2	\$3076.00
Medium - Nitro Gas	Petrol	TOY006BKG2	\$2411.00
Medium - Foam Cell	Petrol	TOY006BKF2	\$2688.00
Medium - Foam Cell Pro	Petrol	TOY006BKP2	\$3020.00
Medium - Nitro Gas	Diesel	TOY006CKG2	\$2466.00
Medium - Foam Cell	Diesel	TOY006CKF2	\$2743.00
Medium - Foam Cell Pro	Diesel	TOY006CKP2	\$3076.00
Heavy - Nitro Gas	Petrol	TOY007BKG2	\$2466.00
Heavy - Foam Cell	Petrol	TOY007BKF2	\$2743.00
Heavy - Foam Cell Pro	Petrol	TOY007BKP2	\$3076.00
Heavy - Nitro Gas	Diesel	TOY007CKG2	\$2522.00
Heavy - Foam Cell	Diesel	TOY007CKF2	\$2799.00
Heavy - Foam Cell Pro	Diesel	TOY007CKP2	\$3131.00

## SUSPENSION KIT CONTENTS

Shock Absorbers

Leaf Springs

U-Bolts

Polyurethane Spring Bushes

# Toyota Landcruiser

60 Series  
Pre 1986



Product Description

Part No.

Qty  
Req

Retail  
ea Inc GST

## SUSPENSION TO SUIT TOYOTA LANDCRUISER

### FRONT SUSPENSION

#### SHOCK ABSORBER

Nitro Gas - Comfort			<b>12637GRC</b>	2	\$153.00
Nitro Gas - Performance			<b>12637GR</b>	2	\$153.00
Foam Cell - Comfort			<b>24637FEC</b>	2	\$222.00
Foam Cell - Performance			<b>24637FE</b>	2	\$222.00
Foam Cell Pro - Comfort			<b>45637FEC</b>	2	\$305.00
Foam Cell Pro - Performance			<b>45637FE</b>	2	\$305.00

#### LEAF SPRINGS

	Est. Lift	Additional Load			
Petrol	50mm	0 - 80kg	<b>TOY006B</b>	2	\$375.00
Diesel or Bullbar	50mm	50 - 100kg	<b>TOY006C</b>	2	\$402.00
Turbo Diesel	50mm	50 - 100kg	<b>TOY006D</b>	2	\$402.00

#### STEERING DAMPER

Foam Cell			<b>3524</b>	1	\$167.00
-----------	--	--	-------------	---	----------

#### U-BOLTS

U-Bolt Kit			<b>436UBK</b>	2	\$42.00
------------	--	--	---------------	---	---------

#### POLYURETHANE SPRING BUSHES

Bush Kit			<b>719UK</b>	1	\$70.00
----------	--	--	--------------	---	---------

#### GREASABLE SHACKLES AND PINS

Greasable Shackle	Left Hand Side		<b>348LH</b>	1	\$70.00
Greasable Shackle	Right Hand Side		<b>348RH</b>	1	\$70.00
Greasable Pin			<b>351</b>	2	\$42.00



60 Series  
Pre 1986

# Toyota Landcruiser

## Product Description

Part No.

Qty  
ReqRetail  
ea Inc GST

### REAR SUSPENSION

#### SHOCK ABSORBER

Nitro Gas - Comfort			<b>12636GRC</b>	2	\$153.00
Nitro Gas - Performance			<b>12636GR</b>	2	\$153.00
Nitro Gas - Professional			<b>12636GRP</b>	2	\$153.00
Foam Cell - Comfort			<b>24636FEC</b>	2	\$222.00
Foam Cell - Performance			<b>24636FE</b>	2	\$222.00
Foam Cell - Professional			<b>24636FEP</b>	2	\$222.00
Foam Cell Pro - Comfort			<b>45636FEC</b>	2	\$305.00
Foam Cell Pro - Performance			<b>45636FE</b>	2	\$305.00
Foam Cell Pro - Professional			<b>45636FEP</b>	2	\$305.00

#### LEAF SPRINGS

	Est. Lift	Additional Load			
Light - Drivers Side	50mm	0 - 200kg	<b>TOY007AD/S</b>	1	\$375.00
Light - Near Side	50mm	0 - 200kg	<b>TOY007AN/S</b>	1	\$375.00
Medium - Drivers Side	50mm	0 - 200kg	<b>TOY007BD/S</b>	1	\$375.00
Medium - Near Side	50mm	0 - 200kg	<b>TOY007BN/S</b>	1	\$375.00
Heavy - Drivers Side	50mm	200kg - GVM	<b>TOY007CD/S</b>	1	\$402.00
Heavy - Near Side	50mm	200kg - GVM	<b>TOY007CN/S</b>	1	\$402.00

• Side hinge barn door models may require (D/S-D/S) or (N/S-N/S) rear spring configuration to maintain level

#### U-BOLTS

U-Bolt Kit			<b>415UBK</b>	2	\$42.00
------------	--	--	---------------	---	---------

#### POLYURETHANE SPRING BUSHES

Bush Kit			<b>719UK</b>	1	\$70.00
----------	--	--	--------------	---	---------

#### GREASABLE SHACKLES AND PINS

Greasable Shackle	Left Hand Side		<b>353LH</b>	1	\$70.00
Greasable Shackle	Right Hand Side		<b>353RH</b>	1	\$70.00
Greasable Pin			<b>351</b>	2	\$42.00

#### HELPER SPRINGS

Load Plus Helper Springs			<b>LP4</b>	1	\$157.00
--------------------------	--	--	------------	---	----------

### SUSPENSION KIT

Light - Nitro Gas	Petrol	<b>TOY006AKG</b>	\$2411.00
Light - Nitro Gas	Diesel	<b>TOY006AKG1</b>	\$2466.00
Light - Foam Cell	Petrol	<b>TOY006AKF</b>	\$2688.00
Light - Foam Cell	Diesel	<b>TOY006AKF1</b>	\$2743.00
Light - Foam Cell Pro	Petrol	<b>TOY006AKP</b>	\$3020.00
Light - Foam Cell Pro	Diesel	<b>TOY006AKP1</b>	\$3076.00
Medium - Nitro Gas	Petrol	<b>TOY006BKG1</b>	\$2411.00
Medium - Nitro Gas	Diesel	<b>TOY006CKG1</b>	\$2466.00
Medium - Foam Cell	Petrol	<b>TOY006BKF1</b>	\$2688.00
Medium - Foam Cell	Diesel	<b>TOY006CKF1</b>	\$2743.00
Medium - Foam Cell Pro	Petrol	<b>TOY006BKP1</b>	\$3020.00
Medium - Foam Cell Pro	Diesel	<b>TOY006CKP1</b>	\$3076.00
Heavy - Nitro Gas	Petrol	<b>TOY007BKG1</b>	\$2466.00
Heavy - Nitro Gas	Diesel	<b>TOY007CKG1</b>	\$2522.00
Heavy - Foam Cell	Petrol	<b>TOY007BKF1</b>	\$2743.00
Heavy - Foam Cell	Diesel	<b>TOY007CKF1</b>	\$2799.00
Heavy - Foam Cell Pro	Petrol	<b>TOY007BKP1</b>	\$3076.00
Heavy - Foam Cell Pro	Diesel	<b>TOY007CKP1</b>	\$3131.00

### SUSPENSION KIT CONTENTS

Shock Absorbers

Leaf Springs

U-Bolts

Polyurethane Spring Bushes

# Toyota Landcruiser

45, 47 Series  
8/1980 to 1985



Product Description

Part No.

Qty  
Req

Retail  
ea Inc GST

## SUSPENSION TO SUIT TOYOTA LANDCRUISER

### FRONT SUSPENSION

#### SHOCK ABSORBER

Nitro Gas - Comfort			<b>12635GRC</b>	2	\$153.00
Nitro Gas - Performance			<b>12635GR</b>	2	\$153.00
Foam Cell - Comfort			<b>24635FEC</b>	2	\$206.00
Foam Cell - Performance			<b>24635FE</b>	2	\$222.00
Foam Cell Pro - Performance			<b>45635FE</b>	2	\$305.00

#### LEAF SPRINGS

	Est. Lift	Additional Load			
Medium	50mm	0 - 80kg	<b>TOY004B</b>	2	\$375.00
Heavy	50mm	80 - 120kg	<b>TOY004C</b>	2	\$375.00

#### STEERING DAMPER

Foam Cell			<b>3523</b>	1	\$167.00
-----------	--	--	-------------	---	----------

#### U-BOLTS

U-Bolt Kit		Drivers Side	<b>449UBK</b>	1	\$42.00
U-Bolt Kit		Near Side	<b>415UBK</b>	1	\$42.00

#### POLYURETHANE SPRING BUSHES

Bush Kit			<b>719UK</b>	1	\$70.00
----------	--	--	--------------	---	---------

#### GREASABLE SHACKLES AND PINS

Greasable Shackle			<b>348LH</b>	1	\$70.00
Greasable Shackle			<b>348RH</b>	1	\$70.00
Greasable Pin			<b>351</b>	2	\$42.00

### REAR SUSPENSION

#### SHOCK ABSORBER

Nitro Gas - Comfort			<b>12636GRC</b>	2	\$153.00
Nitro Gas - Performance			<b>12636GR</b>	2	\$153.00
Nitro Gas - Professional			<b>12636GRP</b>	2	\$153.00
Foam Cell - Comfort			<b>24636FEC</b>	2	\$222.00
Foam Cell - Performance			<b>24636FE</b>	2	\$222.00
Foam Cell - Professional			<b>24636FEP</b>	2	\$222.00
Foam Cell Pro - Comfort			<b>45636FEC</b>	2	\$305.00
Foam Cell Pro - Performance			<b>45636FE</b>	2	\$305.00
Foam Cell Pro - Professional			<b>45636FEP</b>	2	\$305.00

#### LEAF SPRINGS

	Est. Lift	Additional Load			
Medium	50mm	0 - 400kg	<b>TOY005C</b>	2	\$610.00

#### U-BOLTS

U-Bolt Kit			<b>415UBK</b>	2	\$42.00
------------	--	--	---------------	---	---------

#### POLYURETHANE SPRING BUSHES

Bush Kit			<b>719UK</b>	1	\$70.00
----------	--	--	--------------	---	---------

#### GREASABLE SHACKLES AND PINS

Greasable Shackle		Left Hand Side	<b>353LH</b>	1	\$70.00
Greasable Shackle		Right Hand Side	<b>353RH</b>	1	\$70.00
Greasable Pin			<b>351</b>	2	\$42.00

#### HELPER SPRINGS

Load Plus Helper Springs			<b>LP4</b>	1	\$157.00
--------------------------	--	--	------------	---	----------

### SUSPENSION KIT

Heavy - Nitro Gas	<b>TOY005BKG</b>	\$2882.00
Heavy - Foam Cell	<b>TOY005BKF</b>	\$3159.00
Heavy - Foam Cell Pro	<b>TOY005BKP</b>	\$3491.00

### SUSPENSION KIT CONTENTS

Shock Absorbers

Leaf Springs

U-Bolts

Polyurethane Spring Bushes



45 Series  
1960 to 1980

# Toyota Landcruiser

Product Description

Part No.

Qty  
ReqRetail  
ea Inc GST

## SUSPENSION TO SUIT TOYOTA LANDCRUISER

### FRONT SUSPENSION

#### SHOCK ABSORBER

Nitro Gas - Comfort			<b>12635GRC</b>	2	\$153.00
Nitro Gas - Performance			<b>12635GR</b>	2	\$153.00
Foam Cell - Comfort			<b>24635FEC</b>	2	\$206.00
Foam Cell - Performance			<b>24635FE</b>	2	\$222.00
Foam Cell Pro - Performance			<b>45635FE</b>	2	\$305.00

#### LEAF SPRINGS

	Est. Lift	Additional Load			
Medium	50mm	0 - 100kg	<b>TOY001B</b>	2	\$375.00

#### STEERING DAMPER

Foam Cell			<b>3523</b>	1	\$167.00
-----------	--	--	-------------	---	----------

#### U-BOLTS

U-Bolt Kit			<b>415UBK</b>	2	\$42.00
------------	--	--	---------------	---	---------

#### POLYURETHANE SPRING BUSHES

Bush Kit			<b>713UK</b>	1	\$70.00
----------	--	--	--------------	---	---------

#### GREASABLE SHACKLES AND PINS

Greasable Shackle		Left Hand Side	<b>343LH</b>	1	\$70.00
Greasable Shackle		Right Hand Side	<b>343RH</b>	1	\$70.00
Greasable Pin			<b>346</b>	2	\$42.00

### REAR SUSPENSION

#### SHOCK ABSORBER

Nitro Gas - Comfort			<b>12636GRC</b>	2	\$153.00
Nitro Gas - Performance			<b>12636GR</b>	2	\$153.00
Nitro Gas - Professional			<b>12636GRP</b>	2	\$153.00
Foam Cell - Comfort			<b>24636FEC</b>	2	\$222.00
Foam Cell - Performance			<b>24636FE</b>	2	\$222.00
Foam Cell - Professional			<b>24636FEP</b>	2	\$222.00
Foam Cell Pro - Comfort			<b>45636FEC</b>	2	\$305.00
Foam Cell Pro - Performance			<b>45636FE</b>	2	\$305.00
Foam Cell Pro - Professional			<b>45636FEP</b>	2	\$305.00

#### LEAF SPRINGS

	Est. Lift	Additional Load			
Heavy	50mm	0 - 400kg	<b>TOY003C</b>	2	\$610.00

#### U-BOLTS

U-Bolt Kit			<b>415UBK</b>	2	\$42.00
------------	--	--	---------------	---	---------

#### POLYURETHANE SPRING BUSHES

Bush Kit			<b>714UK</b>	1	\$70.00
----------	--	--	--------------	---	---------

#### GREASABLE SHACKLES AND PINS

Greasable Shackle		Left Hand Side	<b>344</b>	1	\$70.00
Greasable Shackle		Right Hand Side	<b>345</b>	1	\$70.00
Greasable Pin			<b>347</b>	2	\$28.00

#### HELPER SPRINGS

Load Plus Helper Springs			<b>LP4</b>	1	\$157.00
--------------------------	--	--	------------	---	----------

### SUSPENSION KIT

Heavy - Nitro Gas			<b>TOY003BKG</b>		\$2882.00
Heavy - Foam Cell			<b>TOY003BKF</b>		\$3159.00
Heavy - Foam Cell Pro			<b>TOY003BKP</b>		\$3491.00

### SUSPENSION KIT CONTENTS

Shock Absorbers

Leaf Springs

U-Bolts

Polyurethane Spring Bushes



# Toyota Landcruiser

40, 42, 46 Series  
1980 to 1984



Product Description

Part No.

Qty  
Req

Retail  
ea Inc GST

## SUSPENSION TO SUIT TOYOTA LANDCRUISER

### FRONT SUSPENSION

#### SHOCK ABSORBER

Nitro Gas - Comfort			<b>12635GRC</b>	2	\$153.00
Nitro Gas - Performance			<b>12635GR</b>	2	\$153.00
Foam Cell - Comfort			<b>24635FEC</b>	2	\$206.00
Foam Cell - Performance			<b>24635FE</b>	2	\$222.00
Foam Cell Pro - Performance			<b>45635FE</b>	2	\$305.00

#### LEAF SPRINGS

	Est. Lift	Additional Load			
Medium	50mm	0 - 80kg	<b>TOY004B</b>	2	\$375.00
Heavy	50mm	80 - 120kg	<b>TOY004C</b>	2	\$375.00

#### STEERING DAMPER

Foam Cell			<b>3523</b>	1	\$167.00
-----------	--	--	-------------	---	----------

#### U-BOLTS

U-Bolt Kit			<b>415UBK</b>	2	\$42.00
------------	--	--	---------------	---	---------

#### POLYURETHANE SPRING BUSHES

Bush Kit			<b>719UK</b>	1	\$70.00
----------	--	--	--------------	---	---------

#### GREASABLE SHACKLES AND PINS

Greasable Shackle	Left Hand Side		<b>348LH</b>	1	\$70.00
Greasable Shackle	Right Hand Side		<b>348RH</b>	1	\$70.00
Greasable Pin			<b>351</b>	2	\$42.00

### REAR SUSPENSION

#### SHOCK ABSORBER

Nitro Gas - Comfort			<b>12636GRC</b>	2	\$153.00
Nitro Gas - Performance			<b>12636GR</b>	2	\$153.00
Nitro Gas - Professional			<b>12636GRP</b>	2	\$153.00
Foam Cell - Comfort			<b>24636FEC</b>	2	\$222.00
Foam Cell - Performance			<b>24636FE</b>	2	\$222.00
Foam Cell - Professional			<b>24636FEP</b>	2	\$222.00
Foam Cell Pro - Comfort			<b>45636FEC</b>	2	\$305.00
Foam Cell Pro - Performance			<b>45636FE</b>	2	\$305.00
Foam Cell Pro - Professional			<b>45636FEP</b>	2	\$305.00

#### LEAF SPRINGS

	Est. Lift	Additional Load			
Heavy	50mm	0 - 200kg	<b>TOY034B</b>	2	\$375.00

#### U-BOLTS

U-Bolt Kit			<b>415UBK</b>	2	\$42.00
------------	--	--	---------------	---	---------

#### POLYURETHANE SPRING BUSHES

Bush Kit			<b>719UK</b>	1	\$70.00
----------	--	--	--------------	---	---------

#### GREASABLE SHACKLES AND PINS

Greasable Shackle	Left Hand Side		<b>348RH</b>	1	\$70.00
Greasable Shackle	Right Hand Side		<b>348LH</b>	1	\$70.00
Greasable Pin			<b>351</b>	2	\$42.00

#### HELPER SPRINGS

Load Plus Helper Springs			<b>LP4</b>	1	\$157.00
--------------------------	--	--	------------	---	----------

### SUSPENSION KIT

Medium - Nitro Gas			<b>TOY004BKG</b>		\$2411.00
Medium - Foam Cell			<b>TOY004BKF</b>		\$2688.00
Medium - Foam Cell Pro			<b>TOY004BKP</b>		\$3020.00

• Specify front Leaf Springs when ordering

### SUSPENSION KIT CONTENTS

Shock Absorbers

Leaf Springs

U-Bolts

Polyurethane Spring Bushes





40 Series  
1960 to 1980

# Toyota Landcruiser

Product Description

Part No.

Qty  
ReqRetail  
ea Inc GST

## SUSPENSION TO SUIT TOYOTA LANDCRUISER

### FRONT SUSPENSION

#### SHOCK ABSORBER

Nitro Gas - Comfort			<b>12635GRC</b>	2	\$153.00
Nitro Gas - Performance			<b>12635GR</b>	2	\$153.00
Foam Cell - Comfort			<b>24635FEC</b>	2	\$206.00
Foam Cell - Performance			<b>24635FE</b>	2	\$222.00
Foam Cell Pro - Performance			<b>45635FE</b>	2	\$305.00

#### LEAF SPRINGS

	Est. Lift	Additional Load			
Medium	50mm	0 - 100kg	<b>TOY001B</b>	2	\$375.00

#### STEERING DAMPER

Foam Cell			<b>3523</b>	1	\$167.00
-----------	--	--	-------------	---	----------

#### U-BOLTS

U-Bolt Kit			<b>415UBK</b>	2	\$42.00
------------	--	--	---------------	---	---------

#### POLYURETHANE SPRING BUSHES

Bush Kit			<b>713UK</b>	1	\$70.00
----------	--	--	--------------	---	---------

#### GREASABLE SHACKLES AND PINS

Greasable Shackle		Left Hand Side	<b>343LH</b>	1	\$70.00
Greasable Shackle		Right Hand Side	<b>343RH</b>	1	\$70.00
Greasable Pin			<b>346</b>	2	\$42.00

### REAR SUSPENSION

#### SHOCK ABSORBER

Nitro Gas - Comfort			<b>12636GRC</b>	2	\$153.00
Nitro Gas - Performance			<b>12636GR</b>	2	\$153.00
Nitro Gas - Professional			<b>12636GRP</b>	2	\$153.00
Foam Cell - Comfort			<b>24636FEC</b>	2	\$222.00
Foam Cell - Performance			<b>24636FE</b>	2	\$222.00
Foam Cell - Professional			<b>24636FEP</b>	2	\$222.00
Foam Cell Pro - Comfort			<b>45636FEC</b>	2	\$305.00
Foam Cell Pro - Performance			<b>45636FE</b>	2	\$305.00
Foam Cell Pro - Professional			<b>45636FEP</b>	2	\$305.00

#### LEAF SPRINGS

	Est. Lift	Additional Load			
Medium	50mm	0 - 200kg	<b>TOY002B</b>	2	\$375.00

#### U-BOLTS

U-Bolt Kit			<b>415UBK</b>	2	\$42.00
------------	--	--	---------------	---	---------

#### POLYURETHANE SPRING BUSHES

Bush Kit			<b>713UK</b>	1	\$70.00
----------	--	--	--------------	---	---------

#### GREASABLE SHACKLES AND PINS

Greasable Shackle		Left Hand Side	<b>343RH</b>	1	\$70.00
Greasable Shackle		Right Hand Side	<b>343LH</b>	1	\$70.00
Greasable Pin			<b>346</b>	2	\$42.00

#### HELPER SPRINGS

Load Plus Helper Springs			<b>LP4</b>	1	\$157.00
--------------------------	--	--	------------	---	----------

### SUSPENSION KIT

Medium - Nitro Gas			<b>TOY001BKG</b>		\$2411.00
Medium - Foam Cell			<b>TOY001BKF</b>		\$2688.00
Medium - Foam Cell Pro			<b>TOY001BKP</b>		\$3020.00

### SUSPENSION KIT CONTENTS

Shock Absorbers

Leaf Springs

U-Bolts

Polyurethane Spring Bushes



## Product Description

## Part No.

Qty  
ReqRetail  
ea Inc GST

## ACCESSORIES TO SUIT TOYOTA PRADO

**STEEL WINCH BULL BARS**

Premium - 60.3mm Tube	BBP064	\$2414.00
Proguard No Loop	BBT064-NL	\$1888.00
Proguard Single Loop Kit	BB064-SL	\$336.00
Proguard Triple Loop Kit	BB064-TL	\$404.00

• Winch with Steel Cable and Roller Fairlead is not suitable - Use Winch with Synthetic Rope and Alloy Hawse only

**STEEL SIDE STEPS AND RAILS**

Premium Side Steps - 60.3mm Tube	SSP064	\$1055.00
Premium Side Rails - 60.3mm Tube	SSP064 RAIL	\$384.00
Premium Side Steps and Rails - 60.3mm Tube	SSRP064	\$1276.00

**RECOVERY POINTS - IRONMAN 4X4 BULL BAR ONLY**

Recovery Points - 5000kg Rating (Pair)	IRP064	\$325.00
--	--------	----------

**LOCKSAFE DRAWER SYSTEMS**

Twin Drawers - 900mm	ITD900	\$1242.00
Single Drawer - 900mm	ISD900	\$767.00
Wing Kit - 900mm	ITDW064	\$270.00
Mounting Kit	ITDFK064	\$152.00

**BATTERY TRAY**

Suits 12" Battery	IBTRAY064	\$138.00
-------------------	-----------	----------

**SNORKEL**

Engine 2.8 1GD-FTV Diesel	ISNORKEL064	\$418.00
---------------------------	-------------	----------

**PREMIUM UNDERBODY PROTECTION**

Engine Bay and Transmission for models without KDSS	UBP047	\$748.00
---	--------	----------

**UNDERBODY PROTECTION**

Engine Bay and Transmission for models without KDSS - <i>While Stocks Last</i>	IUP003K	\$563.00
Fuel Tank - <i>While Stocks Last</i>	IUP003F	\$273.00

• Fuel tank protection plates are not compatible with long range fuel tanks.

**EXHAUST SYSTEM**

3" Exhaust Upgrade 2.8L - DPF Back 2015+ - <i>While Stocks Last</i>	IEX064	\$770.00
---	--------	----------

**STEEL ROOF RACKS**

Cage Style - 1.8m x 1.25m	IRRCAGE18	\$815.00
Rooftop Tent Compatible - 1.8m x 1.25m	IRRTENT18	\$777.00
Trade Style - 1.8m x 1.25m (Open end)	IRRTRADE18	\$777.00

**ALLOY ROOF RACKS**

Cage Style - 1.8m x 1.25m	IRRCAGE18-ALLOY	\$1149.00
Trade Style - 1.8m x 1.25m (Open end)	IRRTRADE18-ALLOY	\$1132.00
Flat Rack - 1.8m x 1.25m	IRRTFLAT18-ALLOY	\$1116.00

**ROOF RACK - MOUNTING KITS**

Toyota Prado 150 Mount Feet (2 Feet)	IRRFEETPRADO150	\$218.00
--------------------------------------	-----------------	----------

**SEAT COVER**

Canvas Comfort - Front	ICSC047F	\$401.00
Canvas Comfort - Rear	ICSC047R	\$401.00

**DIFF BREATHER KIT**

Diff Breather Kit	IDIFFBRE	\$115.00
-------------------	----------	----------



150 Series (Coil)  
12/2017+

SUSPENSION TO SUIT

# Toyota Prado

Product Description

Part No.

Qty  
Req

Retail  
ea Inc GST

## SUSPENSION TO SUIT TOYOTA PRADO

### FRONT SUSPENSION

#### SHOCK ABSORBER

Nitro Gas Strut - Performance			<b>12710GR</b>	2	\$222.00
Foam Cell Strut - Performance			<b>24710FE</b>	2	\$250.00
Foam Cell Pro Strut - Performance			<b>45710FE</b>	2	\$388.00

- Height adjustable with Ironman 4x4 Strut Trim Packers
- Foam Cell Pro, must fit 1198K or 1209K spacer for Sway Bar clearance

#### COIL SPRINGS

	Est. Lift	Additional Load			
Light	45mm	0 - 50kg	<b>TOY065A</b>	1	\$250.00
Medium	45mm	0 - 50kg	<b>TOY065B</b>	1	\$250.00
Heavy	45mm	50 - 110kg	<b>TOY065C</b>	1	\$250.00

#### STRUT MOUNTS

Steel Strut Top			<b>ISST001</b>	2	\$84.00
-----------------	--	--	----------------	---	---------

#### TRIM PACKERS

5mm Strut Trim Packer	Nitro Gas / Foam Cell	<b>HILFR05 / HILFR05F</b>	2	\$28.00
10mm Strut Trim Packer	Nitro Gas / Foam Cell	<b>HILFR10 / HILFR10F</b>	2	\$28.00
15mm Strut Trim Packer	Nitro Gas / Foam Cell	<b>HILFR15 / HILFR15F</b>	2	\$28.00

- ONLY Compatible with Ironman 4x4 Struts (except Pro), lift height subject to 2:1 motion ratio. Unnecessary fitment may lift vehicle too high

#### CONTROL ARMS

Pro-Forge Upper Control Arms			<b>UCA001FA</b>	1	\$882.00
------------------------------	--	--	-----------------	---	----------

#### SPACER KIT

Sway Bar Spacer			<b>1198K</b>	1	\$97.00
Offset Sway Bar Bracket			<b>1209K</b>	1	\$139.00

### REAR SUSPENSION

#### SHOCK ABSORBER

Nitro Gas - Performance			<b>12682GRC</b>	2	\$153.00
Nitro Gas - Professional			<b>12682GRP</b>	2	\$153.00
Foam Cell - Performance			<b>24682FEC</b>	2	\$222.00
Foam Cell - Professional			<b>24682FEP</b>	2	\$222.00
Foam Cell Pro - Performance			<b>45682FEC</b>	2	\$305.00
Foam Cell Pro - Professional			<b>45682FEP</b>	2	\$305.00

#### COIL SPRINGS

	Est. Lift	Additional Load			
Medium	45mm	0 - 300kg	<b>TOY056B</b>	1	\$250.00
Medium - with Accessories	50mm	200 - 400kg	<b>TOY069B</b>	1	\$250.00
Heavy	45mm	300kg - GVM	<b>TOY056C</b>	1	\$250.00

#### PANHARD ROD

Adjustable Panhard Rod for models without KDSS			<b>PANHARD015</b>	1	\$319.00
Adjustable Panhard Rod for models with KDSS			<b>PANHARD015-KDSS</b>	1	\$319.00

#### COIL SPACER

Polyurethane 20mm			<b>LCPR20</b>	2	\$28.00
Polyurethane 25mm			<b>LCPR25</b>	2	\$42.00

#### SWAY BAR LINK

Extended Sway Bar Link for models without KDSS			<b>SBEXT006</b>	2	\$84.00
Rear Sway Bar Spacer for models with KDSS			<b>1220K</b>	1	\$142.00

#### BUMP STOP

Internal Rubber Cone			<b>1218R</b>	2	\$129.00
Airbag Delete Kit for models with Airbags			<b>1218ADK</b>	1	\$436.00

### SUSPENSION KIT

Medium - Nitro Gas	<b>TOY065BKG2</b>	\$1247.00
Medium - Foam Cell	<b>TOY065BKF2</b>	\$1441.00
Medium - Foam Cell Pro	<b>TOY065BKP2</b>	\$2023.00
Heavy - Nitro Gas	<b>TOY065CKG2</b>	\$1247.00
Heavy - Foam Cell	<b>TOY065CKF2</b>	\$1441.00
Heavy - Foam Cell Pro	<b>TOY065CKP2</b>	\$2023.00

- All kits compatible with KDSS, refer KDSS instructions available at [www.ironman4x4.com](http://www.ironman4x4.com)
- Specify front Coil Springs when ordering

### SUSPENSION KIT CONTENTS

Shock Absorbers

Coil Springs

Strut Shock Absorbers

Offset Sway Bar Bracket (Pro Kits Only)







built for adventure!

for a full range of accessories visit our website

[www.ironman4x4.com](http://www.ironman4x4.com)





## Toyota Prado

150 Series  
11/2009 to 10/2013  
11/2013 to 10/2017

## Product Description

## Part No.

Qty  
ReqRetail  
ea Inc GST

## ACCESSORIES TO SUIT TOYOTA PRADO

**STEEL WINCH BULL BARS**Commercial\* - (11/2013 to 10/2017) - *While Stocks Last*

BBC047

\$1678.00

Commercial Deluxe\* - (11/2009 to 10/2013)

BBCD029

\$2284.00

Commercial Deluxe\* - (11/2013 to 10/2017)

BBCD047

\$2284.00

\* Not compatible with sensors or headlight washers.

**STEEL SIDE STEPS AND RAILS**

Side Steps

SS047

\$962.00

Side Steps and Rails

SSR047

\$1155.00

**RECOVERY POINTS - IRONMAN 4X4 BULL BAR ONLY**

Recovery Points - 5000kg Rating (Pair)

IRP064

\$325.00

**LOCKSAFE DRAWER SYSTEMS**

Twin Drawers - 900mm

ITD900

\$1242.00

Single Drawer - 900mm

ISD900

\$767.00

Wing Kit - 900mm

ITDW064

\$270.00

Mounting Kit

ITDFK064

\$152.00

**BATTERY TRAY**

Suits 12" Battery

IBTRAY064

\$138.00

**SNORKEL**

3L D4D TDi / 2.8L D4D TDi / 4L Petrol V6

ISNORKEL035

\$418.00

**PREMIUM UNDERBODY PROTECTION**

Engine Bay and Transmission for models without KDSS

UBP047

\$748.00

**UNDERBODY PROTECTION**Engine Bay and Transmission for models without KDSS - *While Stocks Last*

IUP003K

\$563.00

Fuel Tank - *While Stocks Last*

IUP003F

\$273.00

• Fuel tank protection plates are not compatible with long range fuel tanks.

**EXHAUST SYSTEM**3" Exhaust Upgrade 2.8L - DPF Back 2015+ - *While Stocks Last*

IEX064

\$770.00

**STEEL ROOF RACKS**

Cage Style - 1.8m x 1.25m

IRRCAGE18

\$815.00

Rooftop Tent Compatible - 1.8m x 1.25m

IRR TENT18

\$777.00

Trade Style - 1.8m x 1.25m (Open end)

IRR TRADE18

\$777.00

**ALLOY ROOF RACKS**

Cage Style - 1.8m x 1.25m

IRRCAGE18-ALLOY

\$1149.00

Trade Style - 1.8m x 1.25m (Open end)

IRR TRADE18-ALLOY

\$1132.00

Flat Rack - 1.8m x 1.25m

IRR FLAT18-ALLOY

\$1116.00

**ROOF RACK - MOUNTING KITS**

Toyota Prado 150 Mount Feet (2 Feet)

IRRF EETPRADO150

\$218.00

**SEAT COVER**

Canvas Comfort - Front

ICSC047F

\$401.00

Canvas Comfort - Rear

ICSC047R

\$401.00

**DIFF BREATHER KIT**

Diff Breather Kit

IDIFFBRE

\$115.00



LISTING  
CONTINUED  
OVER THE  
PAGE



Product Description

Part No.

Qty  
Req

Retail  
ea Inc GST

## SUSPENSION TO SUIT TOYOTA PRADO

### FRONT SUSPENSION

#### SHOCK ABSORBER

Nitro Gas Strut - Performance			<b>12750GR</b>	2	\$222.00
Foam Cell Strut - Performance			<b>24750FE</b>	2	\$250.00
Foam Cell Pro Strut - Performance			<b>45750FE</b>	2	\$388.00

• Height adjustable with Ironman 4x4 Strut Trim Packers

• Foam Cell Pro, must fit 1198K or 1209K spacer for Sway Bar clearance

#### COIL SPRINGS

	Est. Lift	Additional Load			
Light	45mm	0 - 50kg	<b>TOY065A</b>	1	\$250.00
Medium - Petrol	45mm	0 - 50kg	<b>TOY065B</b>	1	\$250.00
Heavy - Diesel	45mm	50 - 110kg	<b>TOY065C</b>	1	\$250.00

#### STRUT MOUNTS

Steel Strut Top			<b>ISST001</b>	2	\$84.00
-----------------	--	--	----------------	---	---------

#### TRIM PACKERS

5mm Strut Trim Packer	Nitro Gas / Foam Cell	<b>HILFR05 / HILFR05F</b>	2	\$28.00
10mm Strut Trim Packer	Nitro Gas / Foam Cell	<b>HILFR10 / HILFR10F</b>	2	\$28.00
15mm Strut Trim Packer	Nitro Gas / Foam Cell	<b>HILFR15 / HILFR15F</b>	2	\$28.00

• ONLY Compatible with Ironman 4x4 Struts (except Pro), lift height subject to 2:1 motion ratio. Unnecessary fitment may lift vehicle too high

#### CONTROL ARMS

Pro-Forge Upper Control Arms		<b>UCA001FA</b>	1	\$882.00
------------------------------	--	-----------------	---	----------

#### SPACER KIT

Sway Bar Spacer		<b>1198K</b>	1	\$97.00
Offset Sway Bar Bracket		<b>1209K</b>	1	\$139.00

### REAR SUSPENSION

#### SHOCK ABSORBER

Nitro Gas - Performance			<b>12682GRC</b>	2	\$153.00
Nitro Gas - Professional			<b>12682GRP</b>	2	\$153.00
Foam Cell - Performance			<b>24682FEC</b>	2	\$222.00
Foam Cell - Professional			<b>24682FEP</b>	2	\$222.00
Foam Cell Pro - Performance			<b>45682FEC</b>	2	\$305.00
Foam Cell Pro - Professional			<b>45682FEP</b>	2	\$305.00

#### COIL SPRINGS

	Est. Lift	Additional Load			
Medium - SWB	45mm	0 - 300kg	<b>TOY056A</b>	1	\$250.00
Medium - LWB	45mm	0 - 300kg	<b>TOY056B</b>	1	\$250.00
Medium - LWB with Accessories	50mm	200 - 400kg	<b>TOY069B</b>	1	\$250.00
Heavy	45mm	300kg - GVM	<b>TOY056C</b>	1	\$250.00

#### PANHARD ROD

Adjustable Panhard Rod for models without KDSS		<b>PANHARD015</b>	1	\$319.00
Adjustable Panhard Rod for models with KDSS		<b>PANHARD015-KDSS</b>	1	\$319.00

#### COIL SPACER

Polyurethane 20mm		<b>LCPR20</b>	2	\$28.00
Polyurethane 25mm		<b>LCPR25</b>	2	\$42.00

#### SWAY BAR LINK

Extended Sway Bar Link for models without KDSS		<b>SBEXT006</b>	2	\$84.00
Rear Sway Bar Spacer for models with KDSS		<b>1220K</b>	1	\$142.00

#### BUMP STOP

Internal Rubber Cone		<b>1218R</b>	2	\$129.00
Airbag Delete Kit for models with Airbags		<b>1218ADK</b>	1	\$436.00

# Toyota Prado



150 Series (Coil)  
2009 to 11/2017

Product Description	Part No.	Qty Req	Retail ea Inc GST
---------------------	----------	---------	-------------------

## SUSPENSION KIT

Medium - Nitro Gas	SWB	Petrol	TOY065AKG	\$1247.00
Medium - Nitro Gas	SWB	Diesel	TOY065AKG1	\$1247.00
Medium - Nitro Gas	LWB	Petrol	TOY065BKG	\$1247.00
Medium - Nitro Gas	LWB	Diesel	TOY065BKG1	\$1247.00
Medium - Foam Cell	SWB	Petrol	TOY065AKF	\$1441.00
Medium - Foam Cell	SWB	Diesel	TOY065AKF1	\$1441.00
Medium - Foam Cell	LWB	Petrol	TOY065BKF	\$1441.00
Medium - Foam Cell	LWB	Diesel	TOY065BKF1	\$1441.00
Medium - Foam Cell Pro	SWB	Petrol	TOY065AKP	\$2023.00
Medium - Foam Cell Pro	SWB	Diesel	TOY065AKP1	\$2023.00
Medium - Foam Cell Pro	LWB	Petrol	TOY065BKP	\$2023.00
Medium - Foam Cell Pro	LWB	Diesel	TOY065BKP1	\$2023.00
Heavy - Nitro Gas	LWB	Petrol	TOY065CKG	\$1247.00
Heavy - Nitro Gas	LWB	Diesel	TOY065CKG1	\$1247.00
Heavy - Foam Cell	LWB	Petrol	TOY065CKF	\$1441.00
Heavy - Foam Cell	LWB	Diesel	TOY065CKF1	\$1441.00
Heavy - Foam Cell Pro	LWB	Petrol	TOY065CKP	\$2023.00
Heavy - Foam Cell Pro	LWB	Diesel	TOY065CKP1	\$2023.00

- All kits compatible with KDSS, refer KDSS instructions available at [www.ironman4x4.com](http://www.ironman4x4.com)
- Specify front Coil Springs when ordering

## SUSPENSION KIT CONTENTS

Shock Absorbers	Strut Shock Absorbers	Coil Springs	Offset Sway Bar Bracket (Pro Kits Only)
-----------------	-----------------------	--------------	---



# Toyota Prado

120 Series  
4/2003 to 10/2009



Product Description

Part No.

Qty  
Req

Retail  
ea Inc GST

## ACCESSORIES TO SUIT TOYOTA PRADO

### STEEL WINCH BULL BARS

Commercial Deluxe **BBCD008** \$2244.00

### STEEL SIDE STEPS AND RAILS

Side Steps **SS017** \$962.00

Side Steps and Rails **SSR004** \$1155.00

### LOCKSAFE DRAWER SYSTEMS

Twin Drawers - 900mm **ITD900** \$1242.00

Single Drawer - 900mm **ISD900** \$767.00

### SNORKEL

3L D4D TDi / 4L Petrol V6 **ISNORKEL006** \$418.00

### STEEL ROOF RACKS

Cage Style - 1.8m x 1.25m **IRRCAGE18** \$815.00

Rooftop Tent Compatible - 1.8m x 1.25m **IRRTENT18** \$777.00

Trade Style - 1.8m x 1.25m (Open end) **IRRTRADE18** \$777.00

### ALLOY ROOF RACKS

Cage Style - 1.8m x 1.25m **IRRCAGE18-ALLOY** \$1149.00

Trade Style - 1.8m x 1.25m (Open end) **IRRTRADE18-ALLOY** \$1132.00

Flat Rack - 1.8m x 1.25m **IRRTFLAT18-ALLOY** \$1116.00

### ROOF RACK - MOUNTING KITS

Gutter Mount Feet - 200mm (8 Feet) **IRRFEE TLC200** \$198.00

### UNDERBODY PROTECTION

Engine Bay and Transmission - *While Stocks Last* **IUP002K** \$563.00

### DIFF BREATHER KIT

Diff Breather Kit **IDIFFBRE** \$115.00

## SUSPENSION TO SUIT TOYOTA PRADO

### FRONT SUSPENSION

#### SHOCK ABSORBER

Nitro Gas Strut - Performance **12710GR** 2 \$222.00

Foam Cell Strut - Performance **24710FE** 2 \$250.00

Foam Cell Pro Strut - Performance **45710FE** 2 \$388.00

• Height adjustable with Ironman 4x4 Strut Trim Packers

• Foam Cell Pro, must fit 1198K spacer for Sway Bar clearance

#### COIL SPRINGS

	Est. Lift	Additional Load	Part No.	Qty	Retail Price
Light	30mm	0 - 50kg	<b>TOY055A</b>	1	\$250.00
Medium - Petrol	45mm	0 - 50kg	<b>TOY055B</b>	1	\$250.00
Heavy - Diesel	45mm	50 - 110kg	<b>TOY055C</b>	1	\$250.00

#### STRUT MOUNTS

Steel Strut Top **ISST001** 2 \$84.00

#### TRIM PACKERS

5mm Strut Trim Packer Nitro Gas / Foam Cell **HILFR05 / HILFR05F** 2 \$28.00

10mm Strut Trim Packer Nitro Gas / Foam Cell **HILFR10 / HILFR10F** 2 \$28.00

15mm Strut Trim Packer Nitro Gas / Foam Cell **HILFR15 / HILFR15F** 2 \$28.00

• ONLY Compatible with Ironman 4x4 Struts (except Pro), lift height subject to 2:1 motion ratio. Unnecessary fitment may lift vehicle too high

#### CONTROL ARMS

Pro-Forge Upper Control Arms **UCA001FA** 1 \$882.00

#### SPACER KIT

Sway Bar Spacer **1198K** 1 \$97.00

# Toyota Prado

120 Series  
4/2003 to 10/2009



Product Description	Part No.	Qty Req	Retail ea Inc GST
---------------------	----------	---------	-------------------

## REAR SUSPENSION

### SHOCK ABSORBER

Nitro Gas - Performance	12682GRC	2	\$153.00
Nitro Gas - Professional	12682GRP	2	\$153.00
Foam Cell - Performance	24682FEC	2	\$222.00
Foam Cell - Professional	24682FEP	2	\$222.00
Foam Cell Pro - Performance	45682FEC	2	\$305.00
Foam Cell Pro - Professional	45682FEP	2	\$305.00

### COIL SPRINGS

	Est. Lift	Additional Load			
Medium - SWB	45mm	0 - 300kg	TOY056A	1	\$250.00
Medium - LWB	45mm	0 - 300kg	TOY056B	1	\$250.00
Medium - with accessories LWB	50mm	200 - 400kg	TOY069B	1	\$250.00
Heavy	45mm	300kg - GVM	TOY056C	1	\$250.00

### PANHARD ROD

Adjustable Panhard Rod for models without KDSS	PANHARD015	1	\$319.00
Adjustable Panhard Rod for models with KDSS	PANHARD015-KDSS	1	\$319.00

### SWAY BAR LINK

Extended Sway Bar Link for models without KDSS	SBEXT006	2	\$84.00
Rear Sway Bar Spacer for models with KDSS	1220K	1	\$142.00

### BUMP STOP

Internal Rubber Cone	1218R	2	\$129.00
Airbag Delete Kit for models with Airbags	1218ADK	1	\$436.00

## SUSPENSION KIT

Medium - Nitro Gas	SWB	Petrol	TOY055AKG	\$1247.00
Medium - Nitro Gas	SWB	Diesel	TOY055AKG1	\$1247.00
Medium - Nitro Gas	LWB	Petrol	TOY055BKG	\$1247.00
Medium - Nitro Gas	LWB	Diesel	TOY055BKG1	\$1247.00
Medium - Foam Cell	SWB	Petrol	TOY055AKF	\$1441.00
Medium - Foam Cell	SWB	Diesel	TOY055AKF1	\$1441.00
Medium - Foam Cell	LWB	Petrol	TOY055BKF	\$1441.00
Medium - Foam Cell	LWB	Diesel	TOY055BKF1	\$1441.00
Medium - Foam Cell Pro	SWB	Petrol	TOY055AKP	\$2023.00
Medium - Foam Cell Pro	SWB	Diesel	TOY055AKP1	\$1981.00
Medium - Foam Cell Pro	LWB	Petrol	TOY055BKP	\$2023.00
Medium - Foam Cell Pro	LWB	Diesel	TOY055BKP1	\$1981.00
Heavy - Nitro Gas	LWB	Petrol	TOY055CKG	\$1247.00
Heavy - Nitro Gas	LWB	Diesel	TOY055CKG1	\$1247.00
Heavy - Foam Cell	LWB	Petrol	TOY055CKF	\$1441.00
Heavy - Foam Cell	LWB	Diesel	TOY055CKF1	\$1441.00
Heavy - Foam Cell Pro	LWB	Petrol	TOY055CKP	\$2023.00
Heavy - Foam Cell Pro	LWB	Diesel	TOY055CKP1	\$1981.00

• Specify front Coil Springs when ordering

## SUSPENSION KIT CONTENTS

Shock Absorbers	Strut Shock Absorbers	Coil Springs	Sway Bar Spacer (Pro Kits Only)
-----------------	-----------------------	--------------	---------------------------------





# Toyota Prado

90, 95 Series  
1996 to 10/2002



Product Description

Part No.

Qty  
Req

Retail  
ea Inc GST

## ACCESSORIES TO SUIT TOYOTA PRADO

### STEEL WINCH BULL BARS

Commercial Deluxe	BBCD007	\$2244.00
-------------------	---------	-----------

### SNORKEL

3.4L Petrol V6	ISNORKEL005	\$418.00
----------------	-------------	----------

### LOCKSAFE DRAWER SYSTEMS

Twin Drawers - 900mm	ITD900	\$1242.00
----------------------	--------	-----------

Single Drawer - 900mm	ISD900	\$767.00
-----------------------	--------	----------

Wing Kit - 900mm (GXL)	ITDW004	\$270.00
------------------------	---------	----------

### STEEL ROOF RACKS

Cage Style - 1.8m x 1.25m	IRRCAGE18	\$815.00
---------------------------	-----------	----------

Rooftop Tent Compatible - 1.8m x 1.25m	IRRTENT18	\$777.00
--	-----------	----------

Trade Style - 1.8m x 1.25m (Open end)	IRRTRADE18	\$777.00
---------------------------------------	------------	----------

### ALLOY ROOF RACKS

Cage Style - 1.8m x 1.25m	IRRCAGE18-ALLOY	\$1149.00
---------------------------	-----------------	-----------

Trade Style - 1.8m x 1.25m (Open end)	IRRTRADE18-ALLOY	\$1132.00
---------------------------------------	------------------	-----------

Flat Rack - 1.8m x 1.25m	IRRTFLAT18-ALLOY	\$1116.00
--------------------------	------------------	-----------

### ROOF RACK - MOUNTING KITS

Gutter Mount Feet - 125mm (8 Feet)	IRRFEET125	\$198.00
------------------------------------	------------	----------

### DIFF BREATHER KIT

Diff Breather Kit	IDIFFBRE	\$115.00
-------------------	----------	----------

## Toyota Prado

90, 95 Series  
1996 to 10/2002

Product Description

Part No.

Qty  
ReqRetail  
ea Inc GST

## SUSPENSION TO SUIT TOYOTA PRADO

## FRONT SUSPENSION

## SHOCK ABSORBER

Nitro Gas Strut - Performance			<b>12691GR</b>	2	\$222.00
Foam Cell Strut - Performance			<b>24691FE</b>	2	\$250.00
Foam Cell Pro Strut - Performance			<b>45691FE</b>	2	\$388.00

- Height adjustable with Ironman 4x4 Strut Trim Packers

## COIL SPRINGS

	Est. Lift	Additional Load			
Medium - Petrol	45mm	0 - 50kg	<b>TOY038B</b>	1	\$250.00
Heavy - Diesel	45mm	50 - 110kg	<b>TOY038C</b>	1	\$250.00

## TRIM PACKERS

5mm Strut Trim Packer	Nitro Gas / Foam Cell	<b>HILFR05 / HILFR05F</b>	2	\$28.00
10mm Strut Trim Packer	Nitro Gas / Foam Cell	<b>HILFR10 / HILFR10F</b>	2	\$28.00
15mm Strut Trim Packer	Nitro Gas / Foam Cell	<b>HILFR15 / HILFR15F</b>	2	\$28.00

- ONLY Compatible with Ironman 4x4 Struts (except Pro), lift height subject to 2:1 motion ratio. Unnecessary fitment may lift vehicle too high

## REAR SUSPENSION

## SHOCK ABSORBER

Nitro Gas - Performance			<b>12661GR</b>	2	\$153.00
Foam Cell - Performance			<b>24661FE</b>	2	\$222.00
Foam Cell Pro - Performance			<b>45661FE</b>	2	\$305.00

## COIL SPRINGS

	Est. Lift	Additional Load			
Medium - SWB	45mm	0 - 300kg	<b>TOY039A</b>	1	\$250.00
Medium - LWB	45mm	0 - 300kg	<b>TOY039B</b>	1	\$250.00
Heavy	45mm	300kg - GVM	<b>TOY039C</b>	1	\$250.00

## COIL SPACER

Polyurethane 20mm			<b>LCF20</b>	2	\$28.00
Polyurethane 30mm			<b>LCF30</b>	2	\$42.00

## SUSPENSION KIT

Medium - Nitro Gas	SWB	Petrol	<b>TOY038AKG</b>		\$1247.00
Medium - Nitro Gas	SWB	Diesel	<b>TOY038AKG1</b>		\$1247.00
Medium - Nitro Gas	LWB	Petrol	<b>TOY038BKG</b>		\$1247.00
Medium - Nitro Gas	LWB	Diesel	<b>TOY038CKG</b>		\$1247.00
Medium - Foam Cell	SWB	Petrol	<b>TOY038AKF</b>		\$1441.00
Medium - Foam Cell	SWB	Diesel	<b>TOY038AKF1</b>		\$1441.00
Medium - Foam Cell	LWB	Petrol	<b>TOY038BKF</b>		\$1441.00
Medium - Foam Cell	LWB	Diesel	<b>TOY038CKF</b>		\$1441.00
Medium - Foam Cell Pro	SWB	Petrol	<b>TOY038AKP</b>		\$1884.00
Medium - Foam Cell Pro	SWB	Diesel	<b>TOY038AKP1</b>		\$1884.00
Medium - Foam Cell Pro	LWB	Petrol	<b>TOY038BKP</b>		\$1884.00
Medium - Foam Cell Pro	LWB	Diesel	<b>TOY038CKP</b>		\$1884.00
Heavy - Nitro Gas	LWB	Petrol	<b>TOY038BKG1</b>		\$1247.00
Heavy - Nitro Gas	LWB	Diesel	<b>TOY038CKG1</b>		\$1247.00
Heavy - Foam Cell	LWB	Petrol	<b>TOY038BKF1</b>		\$1441.00
Heavy - Foam Cell	LWB	Diesel	<b>TOY038CKF1</b>		\$1441.00
Heavy - Foam Cell Pro	LWB	Petrol	<b>TOY038BKP1</b>		\$1884.00
Heavy - Foam Cell Pro	LWB	Diesel	<b>TOY038CKP1</b>		\$1884.00

- Specify front Coil Springs when ordering

## SUSPENSION KIT CONTENTS

Shock Absorbers

Strut Shock Absorbers

Coil Springs



Product Description

Part No.

Qty  
Req

Retail  
ea Inc GST

## ACCESSORIES TO SUIT TOYOTA TACOMA

### STEEL WINCH BULL BARS

Raid Bull Bar BBR072 \$1260.00

• Compatible with Ironman 4x4 Cube Lights and Lightbars, refer below for available options

### LIGHTING OPTIONS - TO SUIT RAID BULL BARS (4-6 CUBE LIGHTS PER VEHICLE)

300W Bright Sabre Dual Row Lightbar 815mm ILBDR002B \$411.00

300W Bright Sabre Multi-Function Dual Row Lightbar 815mm ILBDR002BM \$463.00

40W Bright Cube Spot Beam LED Cube Light - 81 x 75mm - Clear ILED80B \$82.00

40W Bright Cube Spot Beam LED Cube Light - 81 x 75mm - Amber ILED80BA \$82.00

40W Bright Cube Flood Beam LED Cube Light - 81 x 75mm - Clear ILED80BF \$82.00

40W Bright Cube Flood Beam LED Cube Light - 81 x 75mm - Amber ILED80BFA \$82.00

10W Spot Beam Universal LED Light - 93mm L - Clear (3rd Light) ILEDWL10 \$49.00

10W Flood Beam Universal LED Light - 93mm L - Amber (3rd Light) ILEDWL10FA \$49.00

### STEEL SIDE STEPS

Raid Rock Slider 1960mm SS072 \$959.00

Raid Rock Slider 2390mm SS072L \$959.00

• Long Bed Models Only

### TOWING

Raid Rear Bumper RTB072 \$1055.00

• Compatible with Ironman 4x4 Cube Lights, refer below for available options

### LIGHTING OPTIONS - TO SUIT RAID REAR BARS (4 CUBE LIGHTS PER VEHICLE)

20W Bright Cube Spot Beam LED Cube Light - 70 x 64mm (Each) - Clear ILED20B \$61.00

20W Bright Cube Spot Beam LED Cube Light - 70 x 64mm (Each) - Amber ILED20BA \$61.00

20W Bright Cube Flood Beam LED Cube Light - 70 x 64mm (Each) - Clear ILED20BF \$61.00

20W Bright Cube Flood Beam LED Cube Light - 70 x 64mm (Each) - Amber ILED20BFA \$61.00

20W Bright Cube Flood Beam LED Cube Light - 70 x 64mm (Each) - Red ILED20BFR \$61.00

### PREMIUM UNDERBODY PROTECTION

Engine Bay and Transmission UBP072 \$712.00

### SLIDE-AWAY ROLL UP HARD TONNEAU COVER

Electric with Remote Control (Long Bed) ISLIDEAWAY072L-E \$2699.00

Electric with Remote Control (Short Bed) ISLIDEAWAY072S-E \$2599.00

### DIFF BREATHER KIT

Diff Breather Kit IDIFFBRE \$115.00



## Toyota Tacoma



2005+

Product Description

Part No.

Qty  
ReqRetail  
ea Inc GST

## SUSPENSION TO SUIT TOYOTA TACOMA

## FRONT SUSPENSION

## SHOCK ABSORBER

Nitro Gas Strut - Performance			<b>12710GR</b>	2	\$222.00
Foam Cell Strut - Performance			<b>24710FE</b>	2	\$250.00
Foam Cell Pro Strut - Performance			<b>45710FE</b>	2	\$388.00

- Height adjustable with Ironman 4x4 Strut Trim Packers

## COIL SPRINGS

	Est. L. lift	Additional Load			
Light	45mm	0 - 50kg	<b>TOY065A</b>	1	\$250.00
Medium	45mm	0 - 50kg	<b>TOY065B</b>	1	\$250.00
Heavy	45mm	50 - 110kg	<b>TOY065C</b>	1	\$250.00

## STRUT MOUNTS

Steel Strut Top			<b>ISST001</b>	2	\$84.00
-----------------	--	--	----------------	---	---------

## TRIM PACKERS

5mm Strut Trim Packer	Nitro Gas / Foam Cell	<b>HILFR05 / HILFR05F</b>	2	\$28.00
10mm Strut Trim Packer	Nitro Gas / Foam Cell	<b>HILFR10 / HILFR10F</b>	2	\$28.00
15mm Strut Trim Packer	Nitro Gas / Foam Cell	<b>HILFR15 / HILFR15F</b>	2	\$28.00

- ONLY Compatible with Ironman 4x4 Struts (except Pro), lift height subject to 2:1 motion ratio. Unnecessary fitment may lift vehicle too high

## CONTROL ARMS

Pro-Forge Upper Control Arms			<b>UCA001FA</b>	1	\$882.00
------------------------------	--	--	-----------------	---	----------

## SPACER KIT

Offset Sway Bar Bracket			<b>1209K</b>	1	\$139.00
-------------------------	--	--	--------------	---	----------

## REAR SUSPENSION

## SHOCK ABSORBER

Nitro Gas - Performance			<b>12744GR</b>	2	\$153.00
Foam Cell - Performance			<b>24744FE</b>	2	\$222.00
Foam Cell Pro - Performance			<b>45744FE</b>	2	\$278.00

## LEAF SPRINGS

	Est. Lift	Additional Load			
Medium - Drivers Side	50mm	0 - 200kg	<b>TOY066BD/S</b>	1	\$513.00
Medium - Near Side	50mm	0 - 200kg	<b>TOY066BN/S</b>	1	\$513.00
Heavy - Drivers Side	50mm	200kg-GVM	<b>TOY066CD/S</b>	1	\$513.00
Heavy - Near Side	50mm	200kg-GVM+	<b>TOY066CN/S</b>	1	\$513.00

## U-BOLTS

U-Bolt Kit			<b>437UBK</b>	2	\$42.00
------------	--	--	---------------	---	---------

## POLYURETHANE SPRING BUSHES

Bush Kit			<b>1191UK</b>	1	\$84.00
----------	--	--	---------------	---	---------

## SPACER KIT

Centre Bearing Spacer Kit			<b>1192K</b>	1	\$28.00
---------------------------	--	--	--------------	---	---------

## HELPER SPRINGS

Load Plus Helper Springs			<b>LP3</b>	1	\$157.00
Add-A-Leaf			<b>ISL6010</b>	1	\$167.00

## SUSPENSION KIT

Medium - Nitro Gas	<b>TOY066BKG</b>	\$2217.00
Medium - Foam Cell	<b>TOY066BKF</b>	\$2411.00
Medium - Foam Cell Pro	<b>TOY066BKP</b>	\$2854.00
Heavy - Nitro Gas	<b>TOY066CKG</b>	\$2217.00
Heavy - Foam Cell	<b>TOY066CKF</b>	\$2411.00
Heavy - Foam Cell Pro	<b>TOY066CKP</b>	\$2854.00

- Specify front Coil Springs when ordering

## SUSPENSION KIT CONTENTS

Shock Absorbers  
Leaf SpringsCoil Springs  
U-BoltsPolyurethane Spring Bushes  
Centre Bearing Spacer Kit

Strut Shock Absorbers



Product Description

Part No.

Qty  
Req

Retail  
ea Inc GST

## ACCESSORIES TO SUIT TOYOTA TUNDRA

### STEEL WINCH BULL BARS

Raid Bull Bar

BBR073

\$1424.00

• Compatible with Ironman 4x4 Cube Lights and Lightbars, refer below for available options

### LIGHTING OPTIONS - TO SUIT RAID BULL BARS (4-6 CUBE LIGHTS PER VEHICLE)

300W Bright Sabre Dual Row Lightbar 815mm

ILBDR002B

\$411.00

300W Bright Sabre Multi-Function Dual Row Lightbar 815mm

ILBDR002BM

\$463.00

40W Bright Cube Spot Beam LED Cube Light - 81 x 75mm - Clear

ILED80B

\$82.00

40W Bright Cube Spot Beam LED Cube Light - 81 x 75mm - Amber

ILED80BA

\$82.00

40W Bright Cube Flood Beam LED Cube Light - 81 x 75mm - Clear

ILED80BF

\$82.00

40W Bright Cube Flood Beam LED Cube Light - 81 x 75mm - Amber

ILED80BFA

\$82.00

10W Spot Beam Universal LED Light - 93mm L - Clear (3rd Light)

ILEDWL10

\$49.00

10W Flood Beam Universal LED Light - 93mm L - Amber (3rd Light)

ILEDWL10FA

\$49.00

### STEEL SIDE STEPS

Raid Rock Slider

SS073

\$959.00

• Crew-Max Models only

### TOWING

Raid Rear Bumper\*

RTB073

\$1055.00

\* Not compatible with rear cross traffic radar models

• Compatible with Ironman 4x4 Cube Lights, refer below for available options

### LIGHTING OPTIONS - TO SUIT RAID REAR BARS (4 CUBE LIGHTS PER VEHICLE)

20W Bright Cube Spot Beam LED Cube Light - 70 x 64mm (Each) - Clear

ILED20B

\$61.00

20W Bright Cube Spot Beam LED Cube Light - 70 x 64mm (Each) - Amber

ILED20BA

\$61.00

20W Bright Cube Flood Beam LED Cube Light - 70 x 64mm (Each) - Clear

ILED20BF

\$61.00

20W Bright Cube Flood Beam LED Cube Light - 70 x 64mm (Each) - Amber

ILED20BFA

\$61.00

20W Bright Cube Flood Beam LED Cube Light - 70 x 64mm (Each) - Red

ILED20BFR

\$61.00

### PREMIUM UNDERBODY PROTECTION

Engine Bay and Transmission

UBP073

\$712.00

### SLIDE-AWAY ROLL UP HARD TONNEAU COVER

Electric with Remote Control (Long Bed)

ISLIDEAWAY073L-E

\$2699.00

Electric with Remote Control (Short Bed)

ISLIDEAWAY073S-E

\$2599.00

### DIFF BREATHER KIT

Diff Breather Kit

IDIFFBRE

\$115.00





## Toyota Tundra

2006 to 2021

Product Description

Part No.

Qty  
ReqRetail  
ea Inc GST

## SUSPENSION TO SUIT TOYOTA TUNDRA

## FRONT SUSPENSION

## SHOCK ABSORBER

Foam Cell Strut - Performance			<b>24780FE</b>	2	\$278.00
Foam Cell Pro Strut - Performance			<b>45780FE</b>	2	\$388.00

- Height adjustable with Ironman 4x4 Strut Trim Packers
- Foam Cell Pro - Must use TOY063B or TOY063C Front Coil Springs

## COIL SPRINGS

	Est. Lift	Additional Load			
Medium	60mm	0 - 50kg	<b>TOY070B</b>	1	\$250.00
Heavy	60mm	50 - 110kg	<b>TOY070C</b>	1	\$250.00

- Not compatible with Foam Cell Pro, refer note above

## STRUT MOUNTS

Steel Strut Top			<b>ISST005</b>	2	\$84.00
-----------------	--	--	----------------	---	---------

## TRIM PACKERS

5mm Strut Trim Packer	Foam Cell		<b>HILFR05F</b>	2	\$28.00
10mm Strut Trim Packer	Foam Cell		<b>HILFR10F</b>	2	\$28.00
15mm Strut Trim Packer	Foam Cell		<b>HILFR15F</b>	2	\$28.00

- ONLY Compatible with Ironman 4x4 Struts (except Pro), lift height subject to 2:1 motion ratio. Unnecessary fitment may lift vehicle too high

## CONTROL ARMS

Pro-Forge Upper Control Arms			<b>UCA073FA</b>	1	\$882.00
------------------------------	--	--	-----------------	---	----------

## REAR SUSPENSION

## SHOCK ABSORBER

Foam Cell - Performance			<b>24781FE</b>	2	\$222.00
Foam Cell Pro - Performance			<b>45781FE</b>	2	\$305.00

## LEAF SPRINGS

	Est. Lift	Additional Load			
Medium	60mm	0 - 200kg	<b>TOY071B</b>	2	\$499.00
Heavy	60mm	200 - 400kg	<b>TOY071C</b>	2	\$513.00

## U-BOLTS

U-Bolt Kit			<b>678UBK</b>	2	\$42.00
------------	--	--	---------------	---	---------

## POLYURETHANE SPRING BUSHES

Bush Kit			<b>1196UK</b>	1	\$84.00
----------	--	--	---------------	---	---------

## DRIVELINE SPACERS

Centre Bearing Spacer Kit			<b>1217K</b>	1	\$28.00
---------------------------	--	--	--------------	---	---------

## SPACER KIT

Brake Hose Relocation Kit			<b>1197K</b>	1	\$42.00
---------------------------	--	--	--------------	---	---------

## GREASABLE SHACKLES AND PINS

Greasable Shackle			<b>1150</b>	2	\$42.00
-------------------	--	--	-------------	---	---------

## HELPER SPRINGS

Load Plus Helper Springs			<b>LP3</b>	1	\$157.00
--------------------------	--	--	------------	---	----------

## SUSPENSION KIT

Medium - Foam Cell			<b>TOY070BKF</b>		\$2452.00
Medium - Foam Cell Pro			<b>TOY070BKP</b>		\$2840.00
Heavy - Foam Cell			<b>TOY070CKF</b>		\$2480.00
Heavy - Foam Cell Pro			<b>TOY070CKP</b>		\$2868.00

- Specify front Coil Springs when ordering

## SUSPENSION KIT CONTENTS

Shock Absorbers

Coil Springs

Polyurethane Spring Bushes

Strut Shock Absorbers

Leaf Springs

U-Bolts

Brake Hose Relocation Kit

# Troller T4

7/2014+



Product Description

Part No.

Qty  
Req

Retail  
ea Inc GST

## SUSPENSION TO SUIT TROLLER T4

### FRONT SUSPENSION

**SHOCK ABSORBER**

Nitro Gas - Performance

**12755GR** 2 \$142.00

**COIL SPRINGS**

Medium Est. Lift 50mm Additional Load 0 - 50kg

**TROL001B** 1 \$219.00

### REAR SUSPENSION

**SHOCK ABSORBER**

Nitro Gas - Performance

**12755GR** 2 \$142.00

**COIL SPRINGS**

Medium Est. Lift 50mm Additional Load 0 - 200kg

**TROL002B** 1 \$219.00

### SUSPENSION KIT

Medium - Nitro Gas

**TROL001BKG** \$1109.00

### SUSPENSION KIT CONTENTS

Shock Absorbers

Coil Springs



1997 to 6/2014

# Troller T4

Product Description

Part No.

Qty  
Req

Retail  
ea Inc GST

## SUSPENSION TO SUIT TROLLER T4

### FRONT SUSPENSION

**SHOCK ABSORBER**

Nitro Gas - Performance

**12765GR**

2

\$142.00

**COIL SPRINGS**

Est. Lift

Additional Load

Medium

45mm

0 - 50kg

**TROL003B**

1

\$219.00

### REAR SUSPENSION

**SHOCK ABSORBER**

Nitro Gas - Performance

**12765GR**

2

\$142.00

**COIL SPRINGS**

Est. Lift

Additional Load

Medium

45mm

0 -200kg

**TROL004B**

1

\$219.00

### SUSPENSION KIT

Medium - Nitro Gas

**TROL003BKG**

\$1109.00

### SUSPENSION KIT CONTENTS

Shock Absorbers

Coil Springs





Product Description

Part No.

Qty  
Req

Retail  
ea Inc GST

## SUSPENSION TO SUIT UAZ HUNTER

### FRONT SUSPENSION

#### SHOCK ABSORBER

Nitro Gas - Performance			<b>12652GR</b>	2	\$153.00
Foam Cell - Performance			<b>24652FE</b>	2	\$222.00

#### COIL SPRINGS

Medium	Est. Lift 45mm	Additional Load 0 - 80kg	<b>IMAZ001B</b>	1	\$231.00
--------	-------------------	-----------------------------	-----------------	---	----------

### REAR SUSPENSION

#### SHOCK ABSORBER

Nitro Gas - Performance			<b>12698GR</b>	2	\$153.00
Foam Cell - Performance			<b>24698FE</b>	2	\$222.00

#### LEAF SPRINGS

Medium	Est. Lift 45mm	Additional Load 0 - 300kg	<b>IMAZ002B</b>	2	\$295.00
--------	-------------------	------------------------------	-----------------	---	----------

#### U-BOLTS

U-Bolt Kit			<b>678UBK</b>	2	\$42.00
------------	--	--	---------------	---	---------

#### POLYURETHANE SPRING BUSHES

Bush Kit			<b>1188UK</b>	1	\$84.00
----------	--	--	---------------	---	---------

#### GREASABLE SHACKLES AND PINS

Greasable Shackle			<b>1189</b>	2	\$70.00
-------------------	--	--	-------------	---	---------

### SUSPENSION KIT

Medium - Nitro Gas			<b>IMAZ001BKG</b>		\$2189.00
Medium - Foam Cell			<b>IMAZ001BKF</b>		\$2466.00

### SUSPENSION KIT CONTENTS

Shock Absorbers	Coil Springs	Polyurethane Spring Bushes
Leaf Springs	U-Bolts	Shackles

# UAZ Patriot



1997+

Product Description

Part No.

Qty  
Req

Retail  
ea Inc GST

## SUSPENSION TO SUIT UAZ PATRIOT

### FRONT SUSPENSION

#### SHOCK ABSORBER

Nitro Gas - Performance			<b>12637GRS</b>	2	\$153.00
Foam Cell - Performance			<b>24637FES</b>	2	\$222.00

#### COIL SPRINGS

	Est. Lift	Additional Load			
Medium	45mm	0 - 80kg	<b>IMAZ001B</b>	1	\$231.00

### REAR SUSPENSION

#### SHOCK ABSORBER

Nitro Gas - Performance			<b>12698GR</b>	2	\$153.00
Foam Cell - Performance			<b>24698FE</b>	2	\$222.00

#### LEAF SPRINGS

	Est. Lift	Additional Load			
Medium	45mm	0 - 300kg	<b>IMAZ002B</b>	2	\$295.00

#### U-BOLTS

U-Bolt Kit			<b>678UBK</b>	2	\$42.00
------------	--	--	---------------	---	---------

#### POLYURETHANE SPRING BUSHES

Bush Kit			<b>1188UK</b>	1	\$84.00
----------	--	--	---------------	---	---------

#### GREASABLE SHACKLES AND PINS

Greasable Shackle			<b>1189</b>	2	\$70.00
-------------------	--	--	-------------	---	---------

### SUSPENSION KIT

Medium - Nitro Gas			<b>IMAZ001BKG1</b>		\$2189.00
Medium - Foam Cell			<b>IMAZ001BKF1</b>		\$2466.00

### SUSPENSION KIT CONTENTS

Shock Absorbers	Coil Springs	Polyurethane Spring Bushes
Leaf Springs	U-Bolts	Greasable Shackles





Product Description

DATE AVAILABLE

Part No.

Qty  
ReqRetail  
ea Inc GST

## ACCESSORIES TO SUIT VOLKSWAGEN AMAROK

**STEEL WINCH BULL BARS**

Commercial Deluxe	BBCD060	\$2284.00
Proguard No Loop	BBT060-NL	\$1888.00
Proguard Single Loop Kit	BB060-SL	\$336.00
Proguard Triple Loop Kit	BB060-TL	\$404.00
Driving Light Patch Loom	IPL060	\$31.00

• Can also be fitted to both 2WD and 4WD models.

**STEEL SIDE STEPS AND RAILS**

Side Steps	SS034	\$962.00
Side Rails	SS034 RAIL	\$317.00
Side Steps and Rails	SSR034	\$1155.00

**TOWING**

Rear Protection Towbar - Full Rear Bumper Replacement (11/2016 to 2020 only)	RTB060	\$1328.00
Towbar Wiring Loom - Plug and Play	ITBL060	\$445.00

**LOCKSAFE DRAWER SYSTEMS**

Twin Drawers - 1300mm	ITD1300	\$1469.00
Single Drawer - 1300mm	ISD1300	\$891.00
Wing Kit - 1300mm	ITDW060	\$351.00

**SNORKEL**

Amarok	ISNORKELO37	\$418.00
--------	-------------	----------

**EXHAUST SYSTEM**

3" Exhaust Upgrade 3.0L V6 - DPF Back - <i>While Stocks Last</i>	IEX060	\$770.00
--	--------	----------

**CANOPY - ABS PLASTIC (SIDE LIFT UP WINDOWS) - FITS 4X4 AND 4X2 DUAL CAB MODELS**

Pre-Primed	CANOPY021-P	\$3238.00*
Candy White (B4B4)	CANOPY021-W	\$3856.00

\* Pre-primed canopies, plus colour coding.

**CANOPY - PINNACLE 2 SMOOTH FINISH FIBREGLASS (SIDE LIFT UP WINDOWS AND CENTRAL LOCKING REAR DOOR) - FITS 4X4 AND 4X2 DUAL CAB MODELS**

Pre-Primed	Q1 2022	ICANOPY060-P	\$2899.00*
Candy White (B4B4)	Q1 2022	ICANOPY060-W	\$3399.00

**SLIDE-AWAY ROLL UP HARD TONNEAU COVER**

Electric with Remote Control	ISLIDEAWAY060-E	\$2599.00
------------------------------	-----------------	-----------

**SEAT COVER**

Canvas Comfort - Front	ICSC060F	\$401.00
Canvas Comfort - Rear	ICSC060R	\$401.00

**DIFF BREATHER KIT**

Diff Breather Kit	IDIFFBRE	\$115.00
-------------------	----------	----------



V6 / 4 Cylinder  
11/2016+

# Volkswagen Amarok

Product Description

Part No.

Qty  
ReqRetail  
ea Inc GST

## SUSPENSION TO SUIT VOLKSWAGEN AMAROK

### FRONT SUSPENSION

#### SHOCK ABSORBER

Nitro Gas Strut - Performance **12725GR** 2 \$222.00

• Height adjustable with Ironman 4x4 Strut Trim Packers

#### COIL SPRINGS

	Est. Lift	Additional Load			
Medium - 4cyl	30mm	0 - 50kg	<b>VOLKS001B</b>	1	\$250.00
Heavy - V6	30mm	50 - 110kg	<b>VOLKS001C</b>	1	\$250.00
Heavy - V6	30mm	50 - 110kg	<b>VOLKS001D</b>	1	\$250.00

#### TRIM PACKERS

5mm Strut Trim Packer	Nitro Gas	<b>HILFR05</b>	2	\$28.00
10mm Strut Trim Packer	Nitro Gas	<b>HILFR10</b>	2	\$28.00
15mm Strut Trim Packer	Nitro Gas	<b>HILFR15</b>	2	\$28.00

• ONLY Compatible with Ironman 4x4 Struts, lift height subject to 2:1 motion ratio. Unnecessary fitment may lift vehicle too high

### REAR SUSPENSION

#### SHOCK ABSORBER

Nitro Gas - Performance **12726GR** 2 \$153.00

#### LEAF SPRINGS

	Est. Lift	Additional Load			
Medium	35mm	0 - 300kg	<b>VOLKS002B</b>	2	\$375.00
Heavy	35mm	200 - 400kg	<b>VOLKS002C</b>	2	\$402.00

U-Bolt Kit

**415UBK** 2 \$42.00

#### POLYURETHANE SPRING BUSHES

Bush Kit 32mm Shackle Bushes **1190UK** 1 \$84.00

#### HELPER SPRINGS

Load Plus Helper Springs **LP4** 1 \$157.00

### SUSPENSION KIT

Medium - Nitro Gas **VOLKS001BKG** \$1912.00  
 Heavy - Nitro Gas **VOLKS001CKG** \$1967.00

• Specify front Coil Springs when ordering

### SUSPENSION KIT CONTENTS

Shock Absorbers  
Leaf Springs

Coil Springs  
U-Bolts

Polyurethane Spring Bushes  
Strut Shock Absorbers



Product Description	DATE AVAILABLE	Part No.	Qty Req	Retail ea Inc GST
---------------------	----------------	----------	------------	----------------------

## ACCESSORIES TO SUIT VOLKSWAGEN AMAROK

### STEEL WINCH BULL BARS

Commercial Deluxe		BBCD034		\$2284.00
Protector - <i>While Stocks Last</i>		BBT034		\$2312.00
Driving Light Patch Loom		IPL060		\$31.00

• Can also be fitted to both 2WD and 4WD models.

### STEEL SIDE STEPS AND RAILS

Side Steps		SS034		\$962.00
Side Rails		SS034 RAIL		\$317.00
Side Steps and Rails		SSR034		\$1155.00

### TOWING

Towbar Wiring Loom - Plug and Play		ITBL060		\$445.00
------------------------------------	--	---------	--	----------

### LOCKSAFE DRAWER SYSTEMS

Twin Drawers - 1300mm		ITD1300		\$1469.00
Single Drawer - 1300mm		ISD1300		\$891.00
Wing Kit - 1300mm*		ITDW040		\$351.00

\*Designed to suit factory tubs, will not suit ute liner without modification.

### SNORKEL

Amarok		ISNORKEL037		\$418.00
--------	--	-------------	--	----------

### UNDERBODY PROTECTION

Engine Bay and Transmission - <i>While Stocks Last</i>		IUP012K		\$636.00
--	--	---------	--	----------

### CANOPY - ABS PLASTIC (SIDE LIFT UP WINDOWS) - FITS 4X4 AND 4X2 DUAL CAB MODELS

Pre-Primed		CANOPY021-P		\$3238.00*
Candy White (B4B4)		CANOPY021-W		\$3856.00
Black (2T2)		CANOPY021-B		\$3856.00

\* Pre-primed canopies, plus colour coding.

### CANOPY - PINNACLE 2 SMOOTH FINISH FIBREGLASS (SIDE LIFT UP WINDOWS AND CENTRAL LOCKING REAR DOOR) - FITS 4X4 AND 4X2 DUAL CAB MODELS

Pre-Primed	Q1 2022	ICANOPY060-P		\$2899.00*
Candy White (B4B4)	Q1 2022	ICANOPY060-W		\$3399.00

### SLIDE-AWAY ROLL UP HARD TONNEAU COVER

Electric with Remote Control		ISLIDEAWAY060-E		\$2599.00
------------------------------	--	-----------------	--	-----------

### SEAT COVER

Canvas Comfort - Front		ICSC060F		\$401.00
Canvas Comfort - Rear		ICSC060R		\$401.00

### DIFF BREATHER KIT

Diff Breather Kit		IDIFFBRE		\$115.00
-------------------	--	----------	--	----------



1997 to 10/2016

# Volkswagen Amarok

Product Description

Part No.

Qty  
ReqRetail  
ea Inc GST

## SUSPENSION TO SUIT VOLKSWAGEN AMAROK

### FRONT SUSPENSION

#### SHOCK ABSORBER

Nitro Gas Strut - Performance **12725GR** 2 \$222.00

• Height adjustable with Ironman 4x4 Strut Trim Packers

#### COIL SPRINGS

	Est. Lift	Additional Load			
Medium - 4cyl	30mm	0 - 50kg	<b>VOLKS001B</b>	1	\$250.00
Heavy - V6	30mm	50 - 110kg	<b>VOLKS001C</b>	1	\$250.00
Heavy - V6	30mm	50 - 110kg	<b>VOLKS001D</b>	1	\$250.00

#### TRIM PACKERS

5mm Strut Trim Packer	Nitro Gas	<b>HILFR05</b>	2	\$28.00
10mm Strut Trim Packer	Nitro Gas	<b>HILFR10</b>	2	\$28.00
15mm Strut Trim Packer	Nitro Gas	<b>HILFR15</b>	2	\$28.00

• ONLY Compatible with Ironman 4x4 Struts, lift height subject to 2:1 motion ratio. Unnecessary fitment may lift vehicle too high

### REAR SUSPENSION

#### SHOCK ABSORBER

Nitro Gas - Performance **12726GR** 2 \$153.00

#### LEAF SPRINGS

	Est. Lift	Additional Load			
Medium	35mm	0 - 300kg	<b>VOLKS002B</b>	2	\$375.00
Heavy	35mm	200 - 400kg	<b>VOLKS002C</b>	2	\$402.00

#### U-BOLTS

U-Bolt Kit **415UBK** 2 \$42.00

#### POLYURETHANE SPRING BUSHES

Bush Kit 32mm Shackle Bushes **1190UK** 1 \$84.00

#### HELPER SPRINGS

Load Plus Helper Springs **LP4** 1 \$157.00

### SUSPENSION KIT

Medium - Nitro Gas **VOLKS001BKG** \$1912.00  
 Heavy - Nitro Gas **VOLKS001CKG** \$1967.00

• Specify front Coil Springs when ordering

### SUSPENSION KIT CONTENTS

Shock Absorbers  
Leaf Springs

Coil Springs  
U-Bolts

Polyurethane Spring Bushes  
Strut Shock Absorbers



redefining 4x4 suspension!

for a full range of suspension visit our website

[www.ironman4x4.com](http://www.ironman4x4.com)





# ***Spare Parts***

## ***CATALOGUE AND PRICE LIST***

***Effective 1 November 2021***

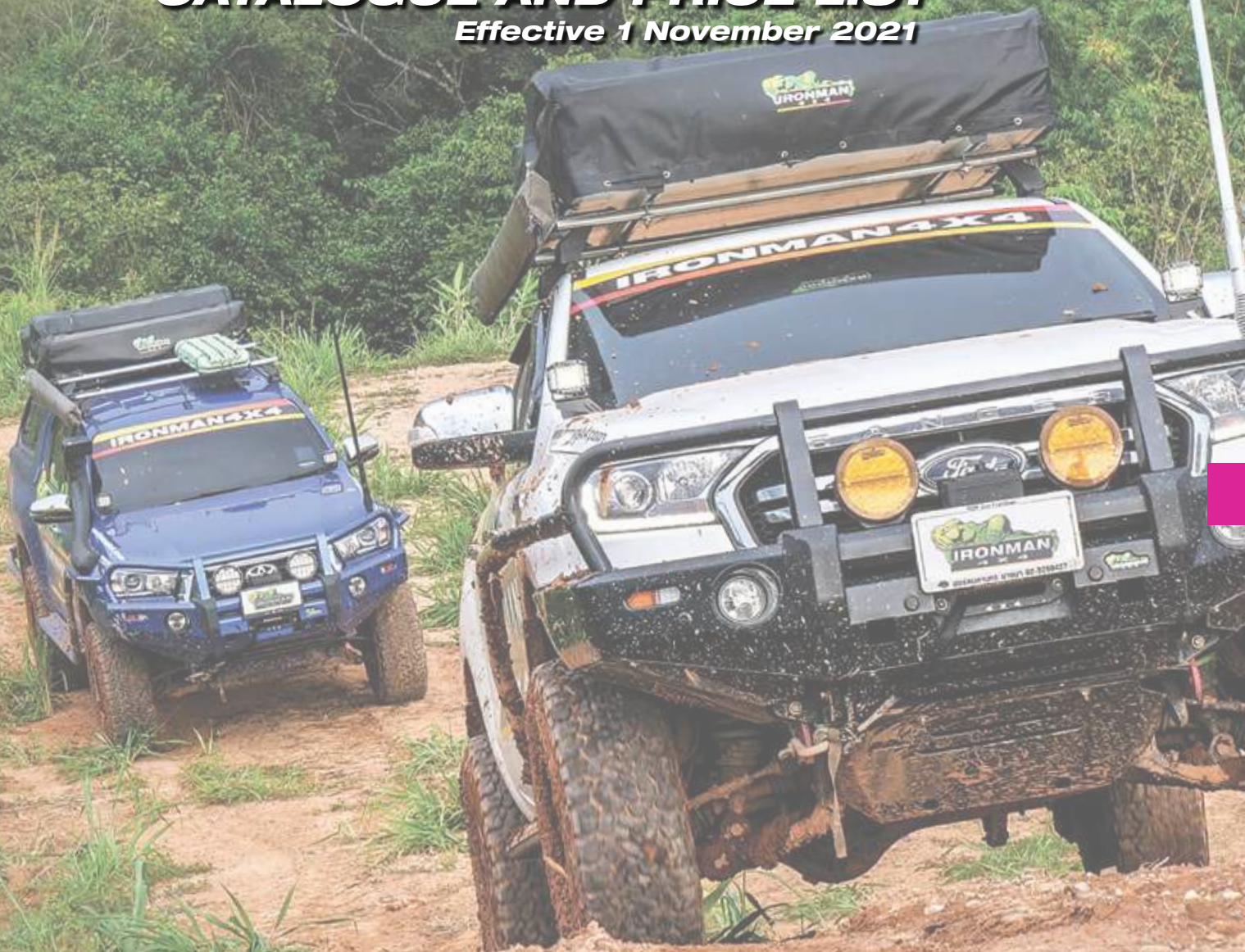



# Spare Parts

Product Description

Part No.

Retail  
ea Inc GST

## BULL BARS

Bullbar Indicator - LED Park/Indicator/DRL (Pair)	BBPART002	\$165.00
1m Pinch Weld for Bumper Cut	BBPART006	\$5.00
Bull Bar Fog Light - Halogen (Pair)	BBPART008	\$122.00
Plastic Light Pod and Bracket - Old Style Triangle Unit (Each)	BBPART009	-
Plastic Light Pod Surround L/H	BBPART009 L/H	\$43.00
Plastic Light Pod Surround R/H	BBPART009 R/H	\$43.00
Bumper Override for BBT - New Style (Pair)	BBPART010	\$75.00
Bumper Override for BBC (Pair)	BBPART011	\$75.00
Wiring Loom - New Style	BBPART012	\$53.00
Plastic Inserts to sui Hilux Vigo BB002 (Pair)	BBPART013	\$15.00
Ironman 4x4 Bull Bar Logo Badge	BBPART014	\$4.00
Bumper Override for BBC/ BBCD033 to BBC/ BBCD049	BBPART015	\$75.00
Indicator Light Brackets	BBPART017	\$2.00
Ironman 4x4 Logo Resin Style SS/ SSR Rails	BBPART019	\$3.00
Bumper Override for BBCD035	BBPART020	\$75.00
Washer Bottle to Suit BBC050/ BBCD050/ BBT050	BBPART021	\$38.00
Plastic Light Pod Insert L/H (Single)	BBPART022-LH	\$43.00
Plastic Light Pod Insert R/H (Single)	BBPART022-RH	\$43.00
Bull Bar Loop O-Ring Kit	BBPART023	\$9.00
Bumper Override For BBC051/ BBCD051 onwards	BBPART024	\$75.00
Bumper Override for BBT051 onwards	BBPART025	\$75.00
Licence Plate Bracket	BBPART026	\$22.00
Bull Bar LED Fog Light (Pair)	BBPART031	\$109.00
Load Resistor Kit with Mount Brackets for 12V/21W Indicator/Parker Replacement	LR12V21W	\$49.00
Triple Stainless Steel Loop for BBT001	BBPARTLOOP001	\$318.00
Triple Stainless Steel Loop for BBT002	BBPARTLOOP002	\$318.00
Triple Stainless Steel Loop for BBT003	BBPARTLOOP003	\$318.00
Triple Stainless Steel Loop for BBT004	BBPARTLOOP004	\$318.00
Triple Stainless Steel Loop for BBT005/ 006	BBPARTLOOP005	\$318.00
Triple Stainless Steel Loop for BBT007	BBPARTLOOP007	\$318.00
Triple Stainless Steel Loop for BBT008	BBPARTLOOP008	\$318.00
Triple Stainless Steel Loop for BBT009	BBPARTLOOP009	\$318.00
Triple Stainless Steel Loop for BBT010	BBPARTLOOP010	\$318.00
Triple Stainless Steel Loop for BBT011	BBPARTLOOP011	\$318.00
Triple Stainless Steel Loop for BBT012	BBPARTLOOP012	\$318.00
Triple Stainless Steel Loop for BBT013	BBPARTLOOP013	\$318.00
Triple Stainless Steel Loop for BBT014	BBPARTLOOP014	\$318.00
Triple Stainless Steel Loop for BBT016	BBPARTLOOP016	\$318.00
Triple Stainless Steel Loop for BBT019	BBPARTLOOP019	\$318.00
Triple Stainless Steel Loop for BBT020	BBPARTLOOP020	\$318.00
Triple Stainless Steel Loop for BBT024	BBPARTLOOP024	\$318.00
Triple Stainless Steel Loop for BBT025	BBPARTLOOP025	\$318.00
Triple Stainless Steel Loop for BBT027	BBPARTLOOP027	\$318.00
Triple Stainless Steel Loop for BBT029	BBPARTLOOP029	\$318.00
Triple Stainless Steel Loop for BBT031	BBPARTLOOP031	\$318.00
Triple Stainless Steel Loop for BBT033	BBPARTLOOP033	\$318.00
Triple Stainless Steel Loop for BBT034	BBPARTLOOP034	\$318.00
Triple Stainless Steel Loop for BBT037	BBPARTLOOP037	\$318.00
Triple Stainless Steel Loop for BBT038	BBPARTLOOP038	\$318.00
Triple Stainless Steel Loop for BBT039	BBPARTLOOP039	\$318.00
Triple Stainless Steel Loop for BBT040	BBPARTLOOP040	\$318.00
Triple Stainless Steel Loop for BBT041	BBPARTLOOP041	\$318.00
Triple Stainless Steel Loop for BBT042	BBPARTLOOP042	\$318.00
Triple Stainless Steel Loop for BBT043	BBPARTLOOP043	\$318.00
Triple Stainless Steel Loop for BBT044	BBPARTLOOP044	\$318.00
Triple Stainless Steel Loop for BBT045	BBPARTLOOP045	\$318.00



## Spare Parts

Product Description	Part No.	Retail ea Inc GST
Triple Stainless Steel Loop for BBT047	BBPARTLOOP047	\$318.00
Triple Stainless Steel Loop for BBT048	BBPARTLOOP048	\$318.00
Triple Stainless Steel Loop for BBT049	BBPARTLOOP049	\$318.00
Triple Stainless Steel Loop for BBT050	BBPARTLOOP050	\$318.00
Triple Stainless Steel Loop for BBT051	BBPARTLOOP051	\$318.00
Triple Stainless Steel Loop for BBT054	BBPARTLOOP054	\$318.00
Triple Stainless Steel Loop for BBT056/ 056xv	BBPARTLOOP056	\$318.00
Triple Stainless Steel Loop for BBT057	BBPARTLOOP057	\$318.00
Triple Stainless Steel Loop for BBT058	BBPARTLOOP058	\$318.00

**CANOPIES**

Mount Kit for CANOPY014	CANOPY MOUNT KIT 014	\$163.00
Mount Kit for CANOPY015	CANOPY MOUNT KIT 015	\$163.00
Rear Door Handle and Key Set (For Non Central Locking Models)	CANOPYSPARE001	\$161.00
Rear Window Gas Strut CANOPY001/ 002/ 005/ 006/ 007 (Pair)	CANOPYSPARE002	\$101.00
Rear Window Gas Strut for CANOPY003/ 004 (Pair)	CANOPYSPARE003	\$129.00
Plate Side Lock Set All Models to CANOPY008 (Striker)	CANOPYSPARE004	\$40.00
Canopy Internal Light (All Models)	CANOPYSPARE005	\$37.00
Rubber Seal Kit Suits All to CANOPY007	CANOPYSPARE006	\$29.00
Rubber Seal Kit CANOPY008 to CANOPY011	CANOPYSPARE007	\$42.00
Rear Window Bolt Set for CANOPY003/ 004	CANOPYSPARE008	\$50.00
Edge Seal Kit for CANOPY006	CANOPYSPARE009	\$57.00
Edge Seal Kit for CANOPY005	CANOPYSPARE010	\$57.00
Edge Seal Kit for CANOPY001/ 002	CANOPYSPARE012	\$28.00
Replacement LED Brakelight (All Models)	CANOPYSPARE013	\$39.00
Sliding Window L/H for CANOPY001/ 002/ 005/ 006/ 007/ 009	CANOPYSPARE014	\$466.00
Sliding Window L/H for CANOPY003/ 004	CANOPYSPARE015	\$482.00
Sliding Window R/H for CANOPY003/ 004	CANOPYSPARE016	\$450.00
Sliding Window R/H for CANOPY001/ 002/ 005/ 006/ 007/ 009	CANOPYSPARE017	\$467.00
Rear Glass Rod Set for CANOPY001 to CANOPY007 and CANOPY009	CANOPYSPARE018	\$39.00
Rear Side Plate Lock Set for CANOPY010	CANOPYSPARE019	\$31.00
Rear Side Plate Lock Set for CANOPY009/ 011	CANOPYSPARE020	\$33.00
Sliding Window R/H for CANOPY008/ 010/ 011/ 012	CANOPYSPARE021	\$466.00
Sliding Window L/H for CANOPY008/ 010/ 011/ 012	CANOPYSPARE022	\$466.00
Rear Window Gas Strut for CANOPY011 (Pair)	CANOPYSPARE023	\$123.00
Rear Window Bolt Set for CANOPY001/ 002/ 005/ 006/ 007	CANOPYSPARE024	\$6.00
Rotary Lock for CANOPY008	CANOPYSPARE025	\$59.00
Rear Window Hinge Set for CANOPY001/ 002/ 005/ 006/ 007/ 009	CANOPYSPARE026	\$180.00
Rear Window Hinge Set for CANOPY008	CANOPYSPARE027	\$159.00
Rear Window Hinge Set for CANOPY010	CANOPYSPARE028	\$192.00
Rear Window Hinge Set for CANOPY011	CANOPYSPARE029	\$160.00
Rear Window Bolt Set Upper for CANOPY010	CANOPYSPARE031	\$11.00
Front Sliding Window for CANOPY001/ 005/ 006/ 007/ 008/ 010/ 014	CANOPYSPARE032	\$340.00
Rear Window Gas Strut for CANOPY010 (Pair)	CANOPYSPARE033	\$126.00
Rear Window Gas Strut for CANOPY008 (Pair)	CANOPYSPARE034	\$127.00
Rotary Lock Set for CANOPY010/ 011/ 012	CANOPYSPARE035	\$68.00
Mount Kit for CANOPY001	CANOPYSPARE036	\$159.00
Mount Kit for CANOPY002	CANOPYSPARE037	\$134.00
Mount Kit for CANOPY003	CANOPYSPARE038	\$154.00
Mount Kit for CANOPY004	CANOPYSPARE039	\$165.00
Mount Kit for CANOPY005	CANOPYSPARE040	\$165.00
Mount Kit for CANOPY006	CANOPYSPARE041	\$165.00
Mount Kit for CANOPY007	CANOPYSPARE042	\$165.00
Mount Kit for CANOPY008	CANOPYSPARE043	\$165.00
Mount Kit for CANOPY009	CANOPYSPARE044	\$255.00
Mount Kit for CANOPY010	CANOPYSPARE045	\$261.00
Mount Kit for CANOPY011	CANOPYSPARE046	\$218.00
Mount Kit for CANOPY012	CANOPYSPARE047	\$274.00



## Spare Parts

Product Description

Part No.

Retail  
ea Inc GST**CANOPIES - CONTINUED**

Side Lift Up Window L/H for CANOPY001/ 002/ 005/ 006/ 007/ 009	CANOPYSPARE048	\$711.00
Side Lift Up Window R/H for CANOPY001/ 002/ 005/ 006/ 007/ 009	CANOPYSPARE049	\$711.00
Side Lift Up Window L/H for CANOPY003/ 004	CANOPYSPARE050	\$714.00
Side Lift Up Window R/H for CANOPY003/ 004	CANOPYSPARE051	\$714.00
Side Lift Up Window L/H for CANOPY008/ 010/ 011/ 012	CANOPYSPARE052	\$714.00
Side Lift Up Window R/H for CANOPY008/ 010/ 011/ 012	CANOPYSPARE053	\$714.00
Rubber Window Seal Kit for CANOPY001/ 002/ 003/ 004	CANOPYSPARE054	\$57.00
Window Rubber Seal Kit for CANOPY008	CANOPYSPARE055	\$52.00
Mounting Kit Seal for CANOPY010	CANOPYSPARE056	\$57.00
Window Rubber Seal Kit for CANOPY011	CANOPYSPARE057	\$52.00
Rear Window Bolt Set Lower Series 1	CANOPYSPARE058	\$8.00
Rear Window Bolt Set Lower for CANOPY010	CANOPYSPARE059	\$11.00
Ironman 4x4 Resin Logo Small	CANOPYSPARE060	\$20.00
Side Lift Up Window Handle for Series 1/ 2 (Set of 4)	CANOPYSPARE061	\$91.00
Side lift Up Window Handle for Series 3 (Set of 4)	CANOPYSPARE062	\$91.00
Rear Window Gas Strut for CANOPY009 (Pair)	CANOPYSPARE063	\$127.00
Front Sliding Window for CANOPY011/ 012	CANOPYSPARE064	\$393.00
Rear Window Lock and Key Set for CANOPY014/ 015	CANOPYSPARE066	\$129.00
Side Lift Up Window L/H for CANOPY014	CANOPYSPARE068	\$625.00
Side Lift Up Window R/H for CANOPY014	CANOPYSPARE069	\$714.00
Internal Light - Battery Operated	CANOPYSPARE070	\$54.00
Sliding Window L/H for CANOPY019/ 020	CANOPYSPARE071	\$466.00
Sliding Window R/H for CANOPY019/ 020	CANOPYSPARE072	\$466.00
Lift Up Window L/H for CANOPY019/ 020	CANOPYSPARE073	\$765.00
Lift Up Window R/H for CANOPY019/ 020	CANOPYSPARE074	\$765.00
Rear Door Key Set - Central Locking	CANOPYSPARE075	\$161.00
Rear Window Gas Strut for CANOPY014/ 015 (Pair)	CANOPYSPARE076	\$86.00
Side Lock Set for CANOPY014/ 015	CANOPYSPARE077	\$39.00
Rear Window Seal for CANOPY014/ 015/ 019/ 020	CANOPYSPARE078	\$42.00
Central Locking Solenoid	CANOPYSPARE079	\$58.00
Side Lift Up Window L/H for CANOPY013/ 015	CANOPYSPARE080	\$824.00
Side Lift Up Window R/H for CANOPY013/ 015	CANOPYSPARE081	\$824.00
Sliding Window L/H for CANOPY013/ 015/ 017	CANOPYSPARE082	\$502.00
Sliding Window R/H for CANOPY013/ 015/ 017	CANOPYSPARE083	\$502.00
Rubber Window Seal for Side Windows S3	CANOPYSPARE084	\$58.00
Rear Window Gas Strut for CANOPY012/ 019 (Pair)	CANOPYSPARE085	\$65.00
Rear Window Gas Strut for CANOPY013/ 017/ 018 (Pair)	CANOPYSPARE086	\$65.00
Rear Side Lock Catches for CANOPY019/ 020 (Pair)	CANOPYSPARE087	\$71.00
Sliding Window L/H for CANOPY022	CANOPYSPARE088	\$281.00
Sliding Window R/H for CANOPY022	CANOPYSPARE089	\$281.00
Side Lift Up Window L/H for CANOPY022	CANOPYSPARE090	\$660.00
Side Lift Up Window R/H for CANOPY022	CANOPYSPARE091	\$660.00
Rear Window for CANOPY003	CANOPY003-WINDOW	\$657.00
Rear Window for CANOPY004	CANOPY004-WINDOW	\$608.00
Rear Window for CANOPY005	CANOPY005-WINDOW	\$600.00
Rear Window for CANOPY006	CANOPY006-WINDOW	\$600.00
Rear Window for CANOPY007	CANOPY007-WINDOW	\$484.00
Rear Window for CANOPY008	CANOPY008-WINDOW	\$450.00
Rear Window for CANOPY009	CANOPY009-WINDOW	\$757.00
Rear Window for CANOPY010	CANOPY010-WINDOW	\$751.00
Rear Window Assy for CANOPY010 - Central Locking	CANOPY010-CL WINDOW	\$754.00
Rear Window for CANOPY011	CANOPY011-WINDOW	\$693.00
Rear Window for CANOPY012	CANOPY012-WINDOW	\$714.00
Rear Window Assy for CANOPY014	CANOPY014-WINDOW	\$657.00
Rear Window Assy for CANOPY014 - Central Locking	CANOPY014-CL WINDOW	\$704.00
Rear Window Assy Suits CANOPY015	CANOPY015-WINDOW	\$641.00
Rear Window Assy for CANOPY015 - Central Locking	CANOPY015-CL WINDOW	\$730.00



## Spare Parts

Product Description	Part No.	Retail ea Inc GST
Rear Window Assy Suits CANOPY017	CANOPY017-WINDOW	\$641.00
Rear Window Assy CANOPY019 - Central Locking	CANOPY019-CL WINDOW	\$783.00
Rear Window Assy CANOPY020 - Central Locking	CANOPY020-CL WINDOW	\$789.00
Lift Up Window L/H	CANFIBRESPARE006	\$714.00
Lift Up Window R/H	CANFIBRESPARE007	\$714.00
Front Sliding Window Complete	CANFIBRESPARE010	\$284.00
Rubber Seal Kit Bottom (All Models)	CANFIBRESPARE011	\$53.00
Rear Window Seal Kit (All)	CANFIBRESPARE012	\$25.00
Side Window Seal Kit (All)	CANFIBRESPARE013	\$25.00
Side Lift Up Window Gas Strut (All)	CANFIBRESPARE014	\$51.00
Interior LED Battery Light	CANFIBRESPARE015	\$51.00
Rear LED Brake Light	CANFIBRESPARE016	\$70.00
Canopy Mount Kit (All)	CANFIBRESPARE019	\$51.00
Door Side Bracket and Striker Plate (All)	CANFIBRESPARE020	\$72.00
Rear Door Side Lock Set (All)	CANFIBRESPARE021	\$48.00
Rear Door Hinge Set (All)	CANFIBRESPARE022	\$40.00
Rear Window Gas Strut Brackets (LH / RH)	CANFIBRESPARE023	\$28.00
Side Window Rubber Grommet (Kit of 4)	CANFIBRESPARE024	\$28.00
Roof Rail (All Models)	CANFIBRESPARE025	\$148.00
Fibreglass Canopy Packing Box	CANFIBRESPARE026	\$216.00
Rear Window Gas Strut LH (All Models)	CANFIBRESPARE027	\$76.00
Rear Window Gas Strut RH (All Models)	CANFIBRESPARE028	\$76.00
Rear Door Sidelock RH	CANFIBRESPARE029	\$40.00
Rear Door Sidelock LH	CANFIBRESPARE030	\$40.00
Ironman 4x4 Logo for Fibreglass Canopies (All Models)	CANFIBRESPARE031	\$10.00
Rear Door Bottom Seal (All Models)	CANFIBRESPARE032	\$11.00
Rear Door Sidelock Set RH (NP300 Only)	CANFIBRESPARE033	\$40.00
Rear Door Sidelock Set LH (NP300 Only)	CANFIBRESPARE034	\$40.00
Rear Window Lock and Key Set (NP300 Only)	CANFIBRESPARE035	\$322.00
Side and Rear Window Handle and Key Set	CANFIBRESPARE036	\$418.00
Canopy Mount Kit (MQ-MR Triton)	CANFIBRESPARE037	\$50.00
Canopy Mount Kit (NP300)	CANFIBRESPARE038	\$50.00
Canopy Mount Kit (Hilux Revo)	CANFIBRESPARE039	\$50.00
Rear Window Suits CANFIBRE054 (Includes Fibreglass Frame Black Painted)	CANFIBRE054-WINDOW	\$615.00
Rear Window Suits CANFIBRE050 (Includes Fibreglass Frame Black Painted)	CANFIBRE050-WINDOW	\$615.00
Rear Window Suits CANFIBRE051 (Includes Fibreglass Frame Black Painted)	CANFIBRE051-WINDOW	\$615.00
Rear Window Suits CANFIBRE048 (Includes Fibreglass Frame Black Painted)	CANFIBRE048-WINDOW	\$615.00
Rear Window Suits CANFIBRE057 (Includes Fibreglass Frame Black Painted)	CANFIBRE057-WINDOW	\$615.00
Rear Window for Pinnacle 2 ICANOPY048 (Complete)	ICANOPY048-WINDOW	\$379.00
Rear Window for Pinnacle 2 ICANOPY050 (Complete)	ICANOPY050-WINDOW	\$379.00
Rear Window for Pinnacle 2 ICANOPY051 (Complete)	ICANOPY051-WINDOW	\$379.00
Rear Window for Pinnacle 2 ICANOPY054 (Complete)	ICANOPY054-WINDOW	\$379.00
Rear Window for Pinnacle 2 ICANOPY060 (Complete)	ICANOPY060-WINDOW	\$379.00
Rear Window for Pinnacle 2 ICANOPY074 (Complete)	ICANOPY074-WINDOW	\$379.00
Rear Window for Pinnacle 2 ICANOPY082 (Complete)	ICANOPY082-WINDOW	\$379.00
Sliding Window L/H for Pinnacle 2	ICANOPYSPARE001	\$249.00
Sliding Window R/H for Pinnacle 2	ICANOPYSPARE002	\$249.00
Lift Up Window L/H for Pinnacle 2	ICANOPYSPARE003	\$549.00
Lift Up Window R/H for Pinnacle 2	ICANOPYSPARE004	\$549.00
Lock and Key Set for Pinnacle 2 (Complete)	ICANOPYSPARE005	\$350.00
Side Window Gas Struts for Pinnacle 2	ICANOPYSPARE006	\$99.00
Rear Window (Small) Gas Strut for Pinnacle 2	ICANOPYSPARE007	\$99.00
Rear Window (Large) Gas Strut for Pinnacle 2	ICANOPYSPARE008	\$99.00
Central Locking Actuator for Pinnacle 2	ICANOPYSPARE009	\$29.00
LED Brake Light for Pinnacle 2	ICANOPYSPARE010	\$99.00
LED Internal Light for Pinnacle 2	ICANOPYSPARE011	\$59.00



## Spare Parts

## Product Description

## Part No.

Retail  
ea Inc GST**CANOPIES - CONTINUED**

Rubber Strip for Pinnacle 2 Canopy 050, 051, 054	ICANOPYSARE013	\$45.00
Rubber Strip for Pinnacle 2 Canopy 074	ICANOPYSARE014	\$45.00
Rubber Strip for Pinnacle 2 Canopy 082	ICANOPYSARE015	\$45.00
Rubber Seal for Pinnacle 2 Canopy Side Window	ICANOPYSARE016	\$45.00

**CANOPY / ROOF RACKS**

Cross Bar for Trade Style Fibreglass Canopies	IRRCROSSBAR001	\$274.00
Ironman 4x4 Logo for Cage Roof Racks	BBPART018	\$4.00
Wheel Clamp to suit 18/22 Cage Roof Racks	IRRWHEELCLAMP	\$100.00

**DRIVING LIGHTS**

H11 35W 6000k Bulb for IHID001	IHIDBULB	\$117.00
Bull Bar Light Mount Bracket Suits Blast Series Driving Light	ILEDBLASTMOUNT	\$10.00
Bull Bar Light Mount Bracket Suits Blast Series 2 Driving Light	ILEDBLAST2MOUNT	\$19.00
Bull Bar Light Mount Bracket Suits Comet Series Driving Light	ILEDCOMETMOUNT	\$10.00
Bracket and Fasteners Kit Suits 20W Cube Lights	ILED20SPAREBKTS	\$10.00
Bracket and Fasteners Kit Suits 40W Cube Lights	ILED80SPAREBKTS	\$10.00
Bracket and Fasteners Kit Suits Bright Sabre and Bright Sabre-X Single Row Light Bars	ILBSRSPAREBKTS	\$30.00
Bracket and Fasteners Kit Suits Bright Sabre Single Row Light Bars	ILBSRWSPAREBKTS	\$30.00
Bracket and Fasteners Kit Suits Bright Sabre Dual Row Light Bars	ILBDRSPAREBKTS	\$30.00

**FRIDGES**

Lid for 30, 40 and 50L Fridge	IFRIDGESPARE001	\$85.00
12V Lead for Fridges (All models)	IFRIDGESPARE002	\$28.00
Australian 240V Power Lead for Fridges (All models)	IFRIDGESPARE003	\$13.00
European Power Lead for Fridges (All models) - While Stocks Last	IFRIDGESPARE004	\$13.00
Internal Basket for 30L Fridge	IFRIDGESPARE005	\$37.00
Internal Basket for 40L Fridge	IFRIDGESPARE006	\$41.00
Internal Basket for 50L Fridge	IFRIDGESPARE007	\$49.00
Internal LED Light Suits all Fridges	IFRIDGESPARE008	\$7.00
Digital Control Panel for 30, 40 and 50L Fridge	IFRIDGESPARE009	\$35.00
Control PCB for 30, 40 and 50L Fridge	IFRIDGESPARE010	\$31.00
Compressor Control Suits all Fridges	IFRIDGESPARE011	\$438.00
Battery Protection for 30, 40 and 50L Fridge	IFRIDGESPARE012	\$6.00
DC Fan for 30, 40 and 50L Fridge	IFRIDGESPARE013	\$17.00
Digital Control Panel for 65L Fridge Dual Control	IFRIDGESPARE014	\$90.00
Digital Control Panel for 74L Fridge Single	IFRIDGESPARE015	\$90.00
DC Fan for 65 and 74L Fridge	IFRIDGESPARE016	\$19.00
Hinge for 65 and 74L Fridge (x 1)	IFRIDGESPARE017	\$6.00
American Power Lead for Fridges (All models)	IFRIDGESPARE018	\$13.00
Internal Basket Small for 65L Fridge	IFRIDGESPARE019	\$27.00
Internal Basket Large for 65L Fridge	IFRIDGESPARE020	\$33.00
Internal Basket Small for 74L Fridge	IFRIDGESPARE021	\$25.00
Internal Basket Large for 74L Fridge	IFRIDGESPARE022	\$35.00
Thermometer Probe for 30, 40 and 50L Fridge	IFRIDGESPARE023	\$6.00
Hinge and Spring for 30, 40 and 50L Fridge Lids	IFRIDGESPARE024	\$3.00
Thermometer Probe for 65 and 74L Fridge	IFRIDGESPARE025	\$5.00
Thermometer Probe for 65L Freezer Side	IFRIDGESPARE026	\$5.00
Digital Control Panel for 30, 40 and 50L Fridge (NEW)	IFRIDGESPARE027	\$51.00
Solenoid Valve for 65L Fridge	IFRIDGESPARE028	\$115.00

**INSTANT AWNINGS**

Awning L Mounting Brackets	IAWNINGSARE001	\$23.00
Awning Hinge Joint for Poles	IAWNINGSARE002	\$6.00
Awning Strap and Buckle	IAWNINGSARE003	\$5.00
Awning Foot Piece with Rope	IAWNINGSARE004	\$2.00



## Spare Parts

Product Description	Part No.	Retail ea Inc GST
Awning End Pin	IAWNINGSARE005	\$2.00
Awning Swivel Spacer	IAWNINGSARE006	\$4.00
Awning Twist Lock	IAWNINGSARE007	\$4.00
Awning Outer Pole 25mm - Tube Only	IAWNINGSARE008	\$19.00
Awning Inner Pole 22mm - Tube Only	IAWNINGSARE009	\$19.00
Replacement Awning Cover	IAWNINGSARE010	\$55.00
Awning Square Rubber Catch	IAWNINGSARE011	\$5.00
Awning 2.0 Horizontal External Pole	IAWNINGSARE012	\$38.00
Awning 2.5 Horizontal External Pole	IAWNINGSARE013	\$38.00
Plastic Clip for Awning Room/ Net	IAWNINGSARE014	\$2.00
Horizontal Pole 2m	IAWNINGPART001	\$24.00
Horizontal Pole 2.5m	IAWNINGPART002	\$31.00
Vertical Pole	IAWNINGPART003	\$24.00
Rubber Stopper	IAWNINGPART004	\$4.00
Flex Joint	IAWNINGPART005	\$8.00
Light Strip and Dimmer Kit	IAWNINGPART006	\$58.00
'L' Mounting Bracket (1)	IAWNINGPART007	\$9.00
Guy Ropes and Peg Kit in Bag	IAWNINGPART008	\$20.00
Poles, Ropes, Pegs to suit Awning Room	IAWNINGPART009	\$36.00
Single Guy Ropes (Pair)	IAWNINGPART010	\$9.00

## ROOFTOP TENTS

Travel Cover for Tent	IROOFTENTSPARE001	\$170.00
Mattress Cover	IROOFTENTSPARE002	\$55.00
Mounting Extrusions (x 2)	IROOFTENTSPARE003	\$67.00
Mounting Sliding Plate and Bolt	IROOFTENTSPARE004	\$5.00
Mounting Clamp	IROOFTENTSPARE005	\$7.00
Ladder Bracket (x 2)	IROOFTENTSPARE006	\$15.00
Bungee Cords (x 4)	IROOFTENTSPARE007	\$5.00
Window Rods (x 6)	IROOFTENTSPARE008	\$55.00
Straps for Tent Cover (x 2)	IROOFTENTSPARE010	\$8.00
Front Extrusion Bow	IROOFTENTSPARE011	\$21.00
Base Extrusion 1295mm	IROOFTENTSPARE012	\$30.00
Base Extrusion 1130mm	IROOFTENTSPARE013	\$28.00
Base Mid Extrusion Tongue/Groove (Pair)	IROOFTENTSPARE014	\$45.00
Tent Base Corner Piece	IROOFTENTSPARE015	\$5.00
Main Ladder	IROOFTENTSPARE016	\$218.00
Tent Fly Sheet	IROOFTENTSPARE017	\$178.00
Zip on Base For Cover	IROOFTENTSPARE018	\$16.00
Mattress	IROOFTENTSPARE019	\$203.00
Roof Top Tent Bow	IROOFTENTSPARE020	\$48.00

## SLIDE-AWAY ROLL UP HARD TONNEAU COVERS

Slide-Away Metal Badge	ISLIDESPAREBADGE	\$19.00
Slide-Away Brackets 100mm (Set of 6)	ISLIDESPAREBKT100	\$139.00
Slide-Away Brackets 115mm (Set of 6)	ISLIDESPAREBKT115	\$139.00
Slide-Away Brackets 45mm (Set of 6)	ISLIDESPAREBKT45	\$139.00
Slide-Away Brackets 70mm (Set of 6)	ISLIDESPAREBKT70	\$139.00
Slide-Away Brackets 80mm (Set of 6)	ISLIDESPAREBKT80	\$139.00
Slide-Away Clutch	ISLIDESPARECLUTCH	\$479.00
Slide-Away ECU	ISLIDESPAREECU	\$479.00
Slide-Away Fastener Pack	ISLIDESPAREFSTR	\$50.00
Slide-Away LED Light Module	ISLIDESPARELIGHT	\$70.00
Slide-Away Drive Motor	ISLIDESPAREMOTOR	\$390.00
Slide-Away Remote Control	ISLIDESPAREREMOTE	\$46.00

## Spare Parts

Product Description

Part No.

Retail  
ea Inc GST**SNORKELS**

Snorkel Mesh Inset Suits 3" and 3.5" Hat	<b>ISNORKELSPARE001</b>		\$32.00
Overflow Bottle Suits ISNORKEL020	<b>ISNORKELSPARE002</b>		\$59.00
3" Snorkel Hat	<b>ISNORKEL 3" HAT</b>		\$44.00
3.5" Snorkel Hat	<b>ISNORKEL 3.5" HAT</b>		\$44.00
4" Snorkel Hat	<b>ISNORKEL 4" HAT</b>		\$44.00

**SUSPENSION**

Upper Control Arm Bush to Suit UCA001FA	<b>UCAB001</b>	ea	\$30.00
Upper Control Arm Bush to Suit UCA041FA	<b>UCAB041</b>	ea	\$35.00
Upper Control Arm Bush to Suit UCA041FAS	<b>UCAB041S</b>	ea	\$35.00
Upper Control Arm Bush to Suit UCA048FA	<b>UCAB048</b>	ea	\$35.00
Upper Control Arm Bush to Suit UCA050FA	<b>UCAB050</b>	ea	\$35.00
Upper Control Arm Bush to Suit UCA054FA	<b>UCAB054</b>	ea	\$30.00
Upper Control Arm Bush to Suit UCA056FA	<b>UCAB056</b>	ea	\$35.00
Upper Control Arm Bush to Suit UCA073FA	<b>UCAB073</b>	ea	\$35.00
Upper Control Arm Bush to Suit UCA074FA	<b>UCAB074</b>	ea	\$35.00
Upper Control Arm Bush to Suit UCA075FA	<b>UCAB075</b>	ea	\$35.00
Ball Joint Assembly to Suit UCA001FA	<b>UBJ001K</b>	ea	\$39.00
Ball Joint Assembly to Suit UCA041FA	<b>UBJ041K</b>	ea	\$56.00
Ball Joint Assembly to Suit UCA041FAS	<b>UBJ041SK</b>	ea	\$56.00
Ball Joint Assembly to Suit UCA048FA	<b>UBJ048K</b>	ea	\$48.00
Ball Joint Assembly to Suit UCA050FA	<b>UBJ050K</b>	ea	\$48.00
Ball Joint Assembly to Suit UCA054FA	<b>UBJ054K</b>	ea	\$39.00
Ball Joint Assembly to Suit UCA056FA	<b>UBJ056K</b>	ea	\$51.00
Ball Joint Assembly to Suit UCA073FA	<b>UBJ073K</b>	ea	\$51.00
Ball Joint Assembly to Suit UCA074FA	<b>UBJ074K</b>	ea	\$56.00
Ball Joint Assembly to Suit UCA075FA	<b>UBJ075K</b>	ea	\$51.00
Leaf Spring 3/8" x 4" Centre Bolt	<b>099</b>		\$7.00
Leaf Spring 5/16" x 4" Centre Bolt	<b>098</b>		\$7.00
Leaf Spring 3/8" x 4" Centre Bolt - Extended Head	<b>635</b>		\$14.00
Leaf Spring Plastic Clip Liner	<b>CLINER001</b>		\$3.00
Leaf Spring Plastic Anti-Friction Pad (Oval Locator)	<b>AFPAD001</b>		\$3.00
Leaf Spring Plastic Anti-Friction Pad (Round Locator)	<b>AFPAD002</b>		\$3.00
Leaf Spring 1 Degree Wedge Kit	<b>IWEDGE04</b>		\$56.00
Leaf Spring 2 Degree Wedge Kit	<b>IWEDGE08</b>		\$56.00
Leaf Spring 3 Degree Wedge Kit	<b>IWEDGE10</b>		\$56.00
Leaf Spring 4 Degree Wedge Kit	<b>IWEDGE12</b>		\$56.00
Rubber Sway Bar Chassis Bush 36mm to Suit Nissan Patrol Y62 Front	<b>ISBB60036R</b>		\$28.00
Rubber Sway Bar Axle Mounting Bush 27mm to Suit Nissan Patrol Y62 Rear	<b>ISBB60027R</b>		\$28.00
Rubber Sway Bar Chassis Bush 33mm to Suit Toyota Hilux 2015+ Front	<b>ISBB8033R</b>		\$28.00
Rubber Sway Bar Chassis Bush 38mm to Suit Toyota LC 200 Front	<b>ISBB20038R</b>		\$28.00
Rubber Sway Bar Axle Mounting Bush 33mm to Suit Toyota LC 200 Rear	<b>ISBB20033R</b>		\$28.00
Rubber Sway Bar End Bush to Suit Toyota LC 200 Rear	<b>ISBB200REB</b>		\$10.00
Rubber Sway Bar Chassis Bush 33mm to Suit Toyota LC 70 Front Diesel	<b>ISBB78933R</b>		\$28.00
Rubber Sway Bar End Bush to Suit Toyota LC 70 Front Diesel	<b>ISBB789REB</b>		\$28.00
Chassis Mounting D Bracket to Suit Toyota LC 70 Front Diesel	<b>ISBB789DB</b>		\$28.00
Rubber Sway Bar Chassis Bush 33mm to Suit Toyota LC 70 Front Petrol	<b>ISBB78933R</b>		\$28.00
Rubber Sway Bar End Bush to Suit Toyota LC 70 Front Petrol	<b>ISBB789REB</b>		\$28.00
Chassis Mounting D Bracket to Suit Toyota LC 70 Front Petrol	<b>ISBB789DB</b>		\$28.00
Rubber Sway Bar Axle Mounting Bush 30mm to Suit Toyota LC 70 Rear	<b>ISBB78930R</b>		\$28.00
Rubber Sway Bar End Bush to Suit Toyota LC 70 Rear	<b>ISBB789REB</b>		\$28.00
Axle Mounting D Bracket to Suit Toyota LC 70 Rear	<b>ISBB789DB</b>		\$28.00
Chassis Mounting Bracket Set to Suit Toyota LC 70 Rear	<b>ISBB789RBK</b>		\$111.00



## Spare Parts

Product Description	Part No.	Retail ea Inc GST
<b>SWAGS</b>		
Poles to Suit Single Dome Swag (Set of 3)	ISWAGPART001	\$77.00
Poles to Suit Double Dome Swag (Set of 3)	ISWAGPART002	\$93.00
Swag Single Mattress	ISWAGSPARE001	\$103.00
Swag Double Mattress	ISWAGSPARE002	\$128.00
<b>TOW BARS</b>		
Tow Bar Tongue and Ball	RTBSPARE002	\$89.00
LED Numberplate Light	RTBSPARE003	\$17.00
Plastic Sensor Cover to suit RTB067GLS	RTBSPARE004	\$25.00
<b>UBP UNDERBODY MOUNTING KITS</b>		
Mounting Kit for UBPO19	UBPO19MK	\$39.00
Mounting Kit for UBPO19SC	UBPO19SCMK	\$39.00
Mounting Kit for UBPO33	UBPO33MK	\$39.00
Mounting Kit for UBPO41	UBPO41MK	\$39.00
Mounting Kit for UBPO47	UBPO47MK	\$39.00
Mounting Kit for UBPO47	UBPO48MK	\$39.00
Mounting Kit for UBPO50	UBPO50MK	\$39.00
Mounting Kit for UBPO51	UBPO51MK	\$39.00
Mounting Kit for UBPO54	UBPO54MK	\$39.00
Mounting Kit for UBPO55	UBPO55MK	\$39.00
Mounting Kit for UBPO56	UBPO56MK	\$39.00
Mounting Kit for UBPO57	UBPO57MK	\$39.00
Mounting Kit for UBPO201SY	UBPO201SYMK	\$39.00
<b>WINCHES</b>		
Remote With Wireless Receiver Unit for WWB9500/ 12000	WWB001	\$94.00
Solenoid (All models)	WWB002	\$75.00
Motor for WWB9500	WWB003	\$226.00
Motor with Brake Attachment for WWB9500	WWB003B	\$226.00
Motor for WWB12000 - New	WWB004	\$245.00
Motor with Brake Attachment for WWB12000	WWB004B	\$245.00
Diff Breather Kit for WWB9500/ 12000	WWB005	\$13.00
Tie Bars New Shape (2 Pc) (All models)	WWB006	\$13.00
Clutch Handle (All models)	WWB007	\$13.00
Gearbox Complete for WWW9500/ WWB9500	WWB008	\$262.00
Gearbox Complete for WWW12000/ WWB12000	WWB009	\$262.00
Brush Kit For Motor (All models)	WWB010	\$27.00
Replacement Hook (All models)	WWB011	\$29.00
Drum Support Housing Motor End (All models)	WWB012	\$39.00
Drum Support Housing Gearbox End (All models)	WWB013	\$39.00
Complete Control Box With Remote (All models)	WWB014	\$301.00
Wireless Plug (All models)	WWB015	\$6.00
Winch Cam Lock Brake System for WWW9500/ 12000	WWB016	\$13.00
Winch Drum (All models)	WWB017	\$58.00
Electric Motor Gasket (All models)	WWB018	\$3.00
Control Box Lead Socket for WWB9500/ 12000	WWB023	\$13.00
Plug In Lead for WWB9500/ 12000	WWB024	\$19.00
Internal Brake Replacement for WWW9500/ 12000	WWB025	\$58.00
Ferrule and Pin for Winch Hook	WWB026	\$14.00
Winch Damper Blanket (All models)	WINCH BLANKET	\$39.00
Winch Cam-Lock Brake System for WWB9500/ 12000	WWWBRAKE	\$85.00
Winch Clutch Handle	WWWCLUTCH	\$13.00
Drum For Winches	WWWDRUM	\$58.00



# Spare Parts

Product Description

Part No.

Retail  
ea Inc GST

## WINCHES - CONTINUED

Drum Support Bush	<b>WWWDRUMBUSH</b>	\$8.00
End Plate For Gear Box	<b>WWWENDPLATE GBOX</b>	\$39.00
End Plate For Motor	<b>WWWENDPLATE MOTOR</b>	\$39.00
Fairlead Rollers For Ironman Winch	<b>WWWFAIRLEAD</b>	\$75.00
12000lb Winch Motor	<b>WWWMOTOR12</b>	\$226.00
9500lb Winch Motor	<b>WWWMOTOR95</b>	\$226.00
O-Ring For Inside The Drum For The Brake	<b>WWWORING</b>	\$6.00
Wireless Remote For Winch	<b>WWWREMOTE WIRELESS</b>	\$58.00
Steel Cable Lug for WWW12000/ WWB12000	<b>WWWTAG12</b>	\$5.00
Steel Cable Lug for WWW9500/ WWB9500	<b>WWWTAG95</b>	\$5.00
12000lb Winch Carton	<b>WWWCARTON12</b>	\$17.00
9500lb Winch Carton	<b>WWWCARTON95</b>	\$17.00
Box for WWB9500	<b>WWB019</b>	\$3.00
Box for WWW9500SR	<b>WWB020</b>	\$3.00
Box for WWB12000	<b>WWB021</b>	\$3.00
Box for WWB12000SR	<b>WWB022</b>	\$3.00

• Replacement Battery A23 - Not a Spare Part

## MISCELLANEOUS

Air Compressor Replacement Hose	<b>ICOMPRESSOR AIR LINE</b>	\$26.00
Exhaust Generic Rubber Hanger (set 3) - 40-75mm	<b>IEXH4075</b>	\$14.00



# ***Product Install Time Guide***

**ACCESSORIES AND SUSPENSION**

*Effective 1 November 2021*





# Average Installation Times (in hours)

INSTALLATION OF IRONMAN 4x4 PRODUCTS TO SUIT	TOYOTA HILUX MY21	FORD RANGER	ISUZU D-MAX	SUZUKI GJ JIMNY	TOYOTA LANDCRUISER 200
<b>BULL BARS</b>					
Commercial Bars	3.5	4	4.5	2.5	4
Commercial Deluxe Bars	3.5	4	4.5	N/A	4
Sensors/Cameras/Headlight Washers	0.5	1	0.25	N/A	1
Wire in Fog Lights using OEM Loom and Switches	0.5	N/A	0.5	N/A	0.5
Additional Wire in Fog Lights	1	1	1	N/A	1
<b>WINCHES</b>					
Note: Winch control box relocation may be required if the vehicle is fitted with additional accessories, radar and or camera					
At Time of Installing Bull Bar	1.5	1.5	1.5	2	1.5 - 2
Fit to Existing Bull Bar	3	3	3	4	3
<b>RECOVERY POINTS</b>					
At Time of Installing Bar	0.5	0.5	0.5	0.5	0.5
Fit to Existing Bar	1	1	1	1	1
<b>SIDE STEPS AND RAILS</b>					
Side Steps	1.5	2	1.5	N/A	2
Side Steps and Rails	2.5	3	2.5	N/A	3
<b>TOWBARS</b>					
Towbar	2	2	2	N/A	N/A
Rear Protection Towbar	2	2	2	N/A	N/A
Rear Protection Towbar with Sensors	2.5	2.5	2.5	N/A	N/A
<b>SUSPENSION</b>					
Suspension Fitment	4	4	4	3	4.5
Upper Control Arm	2	2	2	N/A	2
Wheel Alignment	1	1	1	0.5	1
<b>LIGHTS</b>					
Light Bar or Driving Lights on Bull Bar	1.5	1	1	1.5	1
<b>SNORKELS</b>					
All Snorkels	3	3	3	2	3
<b>LONG RANGE FUEL TANKS</b>					
Tanks	4	3.5	3.5	N/A	N/A
<b>UNDERBODY PROTECTION KITS</b>					
UBP	0.75	0.75	1	N/A	0.75
<b>CANOPIES</b>					
ABS Plastic	2	2	3	N/A	N/A
Pinnacle Fibreglass	2	2	3	N/A	N/A
<b>SLIDE-AWAY</b>					
Roll Up Tonneau Cover	2	2	3	N/A	N/A
<b>ROOF RACKS AND FEET</b>					
Racks	1.5	1.5	1.5	1	2
<b>DRAWER SYSTEMS</b>					
Twin Drawers	1	1	1	N/A	2
Single Drawers	0.75	0.75	0.75	N/A	1
Wing Kit	1	1	1	N/A	1

# Average Installation Times (in hours)

INSTALLATION OF IRONMAN 4X4 PRODUCTS TO SUIT	TOYOTA LANDCRUISER 79	MITSUBISHI TRITON MR	TOYOTA PRADO 150	NISSAN NP300 NAVARA	NISSAN GU PATROL
<b>BULL BARS</b>					
Commercial Bars	3	4.5	4.5	3	3
Commercial Deluxe Bars	3	4.5	4.5	3	3
Sensors/Cameras/Headlight Washers	N/A	0.5	0.15	N/A	N/A
Wire in Fog Lights using OEM Loom and Switches	N/A	0.5	0.15	0.5	N/A
Additional Wire in Fog Lights	1	1	1	1	1
<b>WINCHES</b>					
Note: Winch control box relocation may be required if the vehicle is fitted with additional accessories, radar and or camera					
At Time of Installing Bull Bar	1.5	1.5	1.5	1.5	1.5
Fit to Existing Bull Bar	3	3	3	3	3
<b>RECOVERY POINTS</b>					
At Time of Installing Bar	0.5	0.5	0.5	0.5	0.5
Fit to Existing Bar	1	1	1	3	1
<b>SIDE STEPS AND RAILS</b>					
Side Steps	1.5	2.5	1.5	2	1.5
Side Steps and Rails	2.5	2.5	2.5	3	2.5
<b>TOWBARS</b>					
Towbar	N/A	2	N/A	2	N/A
Rear Protection Towbar	N/A	2	N/A	2	N/A
Rear Protection Towbar with Sensors	N/A	3	N/A	2.5	N/A
<b>SUSPENSION</b>					
Suspension Fitment	3	4	4	3	2
Upper Control Arm	N/A	2	2	2	N/A
Wheel Alignment	0.5	1	1	1	0.5
<b>LIGHTS</b>					
Light Bar or Driving Lights on Bull Bar	1	1	2.5	1.5	1
<b>SNORKELS</b>					
All Snorkels	3	3	3	4	4
<b>LONG RANGE FUEL TANKS</b>					
Tanks	N/A	3.5	N/A	3.5	N/A
<b>UNDERBODY PROTECTION KITS</b>					
UBP	0.75	0.75	1	1.5	N/A
<b>CANOPIES</b>					
ABS Plastic	N/A	3	N/A	2	N/A
Pinnacle Fibreglass	N/A	3	N/A	2	N/A
<b>SLIDE-AWAY</b>					
Roll Up Tonneau Cover	N/A	3	N/A	2	N/A
<b>ROOF RACKS AND FEET</b>					
Racks	N/A	1.5	2	1.5	N/A
<b>DRAWER SYSTEMS</b>					
Twin Drawers	1	1	2	1	N/A
Single Drawers	0.75	0.75	1	0.7	N/A
Wing Kit	1	1	1	1	N/A



# ***GVM Upgrades***

***CATALOGUE AND PRICE LIST***

*Effective 1 November 2021*

 **GVM**  
**IRONMAN** UPGRAD

# GVM Upgrades

Product Description

Part No.

Retail  
ea Inc GST

## GVM UPGRADE TO SUIT FORD RANGER

### PX MK III (NOT USA MODEL) 7/2018+ - (PAGE 54)

	Front Axle Rating	Rear Axle Rating	Gross Vehicle Mass (GVM)	Gross Combined Mass (GCM)	Towing Capacity (Braked)
<b>Original Equipment (OE)</b>	1480kg	1850kg	3200kg	6000kg	3500kg
<b>Ironman 4x4</b>	1500kg	2000kg	3500kg	6000kg	3500kg

*These figures are presented as a guide only. Always refer to the owner's manual for load ratings specific to the vehicle*

#### PRE REGISTRATION - 3500KG

#### Additional Payload

Foam Cell Shocks - Temporary Load	+300kg	<b>FOR005BKFGVM</b>	\$3259.87
Foam Cell Shocks - Permanent Load	+300kg	<b>FOR005CKFGVM</b>	\$3312.14
Foam Cell Pro Shocks - Temporary Load	+300kg	<b>FOR005BKPGVM</b>	\$3678.04
Foam Cell Pro Shocks - Permanent Load	+300kg	<b>FOR005CKPGVM</b>	\$3730.31

#### POST REGISTRATION - 3500KG

#### Additional Payload

Foam Cell Shocks - Temporary Load	+300kg	<b>FOR005BKFGVM1</b>	\$3259.87
Foam Cell Shocks - Permanent Load	+300kg	<b>FOR005CKFGVM1</b>	\$3312.15
Foam Cell Pro Shocks - Temporary Load	+300kg	<b>FOR005BKPGVM1</b>	\$3678.04
Foam Cell Pro Shocks - Permanent Load	+300kg	<b>FOR005CKPGVM1</b>	\$3730.31

*Federal Approval CPA47511 - OE Approval No. 43280*

- Only available through authorised Ironman 4x4 GVM upgrade installers
- Plus engineering sign off (Post Registration Only)
- Post Registration, State Approval - Vehicle must be inspected and approved by state authorised automotive engineer for issue of modification plate
- GVM orders must be submitted via the GVM Portal

### GVM UPGRADE KIT CONTENTS

Shock Absorbers	Leaf Springs	Centre Bearing Spacer Kit	SSM Compliance Plate (pre reg. only)
Strut Shock Absorbers	U-Bolts	Greasable Shackles and Pins	GVM Stickers
Coil Springs	Polyurethane Spring Bushes	Tyre Placard	



Product Description

Part No.

Retail  
ea Inc GST

## GVM UPGRADE TO SUIT FORD RANGER

### PX MK II (NOT USA MODEL) 2015 TO 6/2018 - (PAGE 58)

	Front Axle Rating	Rear Axle Rating	Gross Vehicle Mass (GVM)	Gross Combined Mass (GCM)	Towing Capacity (Braked)
<b>Original Equipment (OE)</b>	1480kg	1850kg	3200kg	6000kg	3500kg
<b>Ironman 4x4</b>	1500kg	2000kg	3500kg	6000kg	3500kg

*These figures are presented as a guide only. Always refer to the owner's manual for load ratings specific to the vehicle*

#### POST REGISTRATION - 3500KG

#### Additional Payload

Foam Cell Shocks - Temporary Load	+300kg	<b>FOR001BKFGVM1</b>	\$3259.16
Foam Cell Shocks - Permanent Load	+300kg	<b>FOR001CKFGVM1</b>	\$3311.44
Foam Cell Pro Shocks - Temporary Load	+300kg	<b>FOR001BKPGVM1</b>	\$3677.34
Foam Cell Pro Shocks - Permanent Load	+300kg	<b>FOR001CKPGVM1</b>	\$3729.61

Federal Approval CPA47511 - OE Approval No. 43280

- Only available through authorised Ironman 4x4 GVM upgrade installers
- Plus engineering sign off (Post Registration Only)
- Post Registration, State Approval - Vehicle must be inspected and approved by state authorised automotive engineer for issue of modification plate
- GVM orders must be submitted via the GVM Portal

#### GVM UPGRADE KIT CONTENTS

Shock Absorbers	Leaf Springs	Centre Bearing Spacer Kit	GVM Stickers
Strut Shock Absorbers	U-Bolts	Greasable Shackles and Pins	
Coil Springs	Polyurethane Spring Bushes	Tyre Placard	

## GVM UPGRADE TO SUIT FORD RANGER

### T6 PX (NOT USA MODEL) 2011 TO 2015 - (PAGE 62)

	Front Axle Rating	Rear Axle Rating	Gross Vehicle Mass (GVM)	Gross Combined Mass (GCM)	Towing Capacity (Braked)
<b>Original Equipment (OE)</b>	1480kg	1850kg	3200kg	6000kg	3500kg
<b>Ironman 4x4</b>	1500kg	2000kg	3500kg	6000kg	3500kg

*These figures are presented as a guide only. Always refer to the owner's manual for load ratings specific to the vehicle*

#### POST REGISTRATION - 3500KG

#### Additional Payload

Foam Cell Shocks - Temporary Load	+300kg	<b>FOR001BKFGVM1</b>	\$3259.16
Foam Cell Shocks - Permanent Load	+300kg	<b>FOR001CKFGVM1</b>	\$3311.44
Foam Cell Pro Shocks - Temporary Load	+300kg	<b>FOR001BKPGVM1</b>	\$3677.34
Foam Cell Pro Shocks - Permanent Load	+300kg	<b>FOR001CKPGVM1</b>	\$3729.61

Federal Approval CPA47511 - OE Approval No. 43280

- Only available through authorised Ironman 4x4 GVM upgrade installers
- Plus engineering sign off (Post Registration Only)
- Post Registration, State Approval - Vehicle must be inspected and approved by state authorised automotive engineer for issue of modification plate
- GVM orders must be submitted via the GVM Portal

#### GVM UPGRADE KIT CONTENTS

Shock Absorbers	Leaf Springs	Centre Bearing Spacer Kit	GVM Stickers
Strut Shock Absorbers	U-Bolts	Greasable Shackles and Pins	
Coil Springs	Polyurethane Spring Bushes	Tyre Placard	

# GVM Upgrades

Product Description

Part No.

Retail  
ea Inc GST

## GVM UPGRADE TO SUIT HOLDEN COLORADO

### RG 2016+ - (PAGE 81)

	Front Axle Rating	Rear Axle Rating	Gross Vehicle Mass (GVM)	Gross Combined Mass (GCM)	Towing Capacity (Braked)
<b>Original Equipment (OE)</b>	1450kg	1850kg	3150kg	6000kg	3500kg
<b>Ironman 4x4</b>	1500kg	2000kg	3500kg	6000kg	3500kg

*These figures are presented as a guide only. Always refer to the owner's manual for load ratings specific to the vehicle*

#### POST REGISTRATION - 3500KG

#### Additional Payload

Foam Cell - Temporary Load	up to 400kg	<b>HOLD021CKF2GVM1</b>	\$3312.15
Foam Cell - Permanent Load	up to 400kg	<b>HOLD021DKF2GVM1</b>	\$3312.15
Foam Cell Pro - Temporary Load	up to 400kg	<b>HOLD021CKP2GVM1</b>	\$3730.33
Foam Cell Pro - Permanent Load	up to 400kg	<b>HOLD021DKP2GVM1</b>	\$3730.33

*Federal Approval - CPA50676 - OE Approval No. 49275*

- Only available through authorised Ironman 4x4 GVM upgrade installers
- Plus engineering sign off (Post Registration Only)
- Post Registration, State Approval - Vehicle must be inspected and approved by state authorised automotive engineer for issue of modification plate
- GVM orders must be submitted via the GVM Portal

#### GVM UPGRADE KIT CONTENTS

Shock Absorbers	Leaf Springs	Greasable Shackles and Pins
Strut Shock Absorbers	U-Bolts	Tyre Placard
Coil Springs	Polyurethane Spring Bushes	GVM Stickers

## GVM UPGRADE TO SUIT HOLDEN COLORADO

### RG 2012 TO 2015 - (PAGE 84)

	Front Axle Rating	Rear Axle Rating	Gross Vehicle Mass (GVM)	Gross Combined Mass (GCM)	Towing Capacity (Braked)
<b>Original Equipment (OE)</b>	1300kg	1680kg	2900kg	5400kg - Petrol 5900kg - Diesel	2500kg - Petrol 3000kg - Diesel
<b>Ironman 4x4</b>	1550kg	1950kg	3500kg	5400kg - Petrol 5900kg - Diesel	2500kg - Petrol 3000kg - Diesel

*These figures are presented as a guide only. Always refer to the owner's manual for load ratings specific to the vehicle*

#### POST REGISTRATION - 3500KG

#### Additional Payload

Foam Cell - Temporary Load	up to 600kg	<b>HOLD021CKFGVM1</b>	\$3312.15
Foam Cell - Permanent Load	up to 600kg	<b>HOLD021DKFGVM1</b>	\$3312.15
Foam Cell Pro - Temporary Load	up to 600kg	<b>HOLD021CKPGVM1</b>	\$3730.33
Foam Cell Pro - Permanent Load	up to 600kg	<b>HOLD021DKPGVM1</b>	\$3730.33

*Federal Approval - CPA50676 - OE Approval No. 43669*

- Only available through authorised Ironman 4x4 GVM upgrade installers
- Plus engineering sign off (Post Registration Only)
- Post Registration, State Approval - Vehicle must be inspected and approved by state authorised automotive engineer for issue of modification plate
- GVM orders must be submitted via the GVM Portal

#### GVM UPGRADE KIT CONTENTS

Shock Absorbers	Leaf Springs	Greasable Shackles and Pins
Strut Shock Absorbers	U-Bolts	Tyre Placard
Coil Springs	Polyurethane Spring Bushes	GVM Stickers



Product Description

Part No.

Retail  
ea Inc GST

## GVM UPGRADE TO SUIT ISUZU D-MAX

### MY20+ - (PAGE 99)

	Front Axle Rating	Rear Axle Rating	Gross Vehicle Mass (GVM)	Gross Combined Mass (GCM)	Towing Capacity (Braked)
<b>Original Equipment (OE)</b>	1450kg	1910kg	3100kg	5950kg	3500kg
<b>Ironman 4x4</b>	1500kg	2000kg	3500kg	5950kg	3500kg

*These figures are presented as a guide only. Always refer to the owner's manual for load ratings specific to the vehicle*

#### PRE REGISTRATION - 3500KG

#### Additional Payload

Foam Cell - Temporary Load	up to 500kg	<b>HOLD021CKF3GVM</b>	\$3312.15
Foam Cell - Permanent Load	up to 500kg	<b>HOLD021DKF3GVM</b>	\$3312.15
Foam Cell Pro - Temporary Load	up to 500kg	<b>HOLD021CKP3GVM</b>	\$3730.33
Foam Cell Pro - Permanent Load	up to 500kg	<b>HOLD021DKP3GVM</b>	\$3730.33

#### POST REGISTRATION - 3500KG

#### Additional Payload

Foam Cell - Temporary Load	up to 500kg	<b>HOLD021CKF3GVM1</b>	\$3312.15
Foam Cell - Permanent Load	up to 500kg	<b>HOLD021DKF3GVM1</b>	\$3312.15
Foam Cell Pro - Temporary Load	up to 500kg	<b>HOLD021CKP3GVM1</b>	\$3730.33
Foam Cell Pro - Permanent Load	up to 500kg	<b>HOLD021DKP3GVM1</b>	\$3730.33

*Federal Approval CPA51296 - OE Approval No. 50736*

- Only available through authorised Ironman 4x4 GVM upgrade installers
- Plus engineering sign off (Post Registration Only)
- Post Registration, State Approval - Vehicle must be inspected and approved by state authorised automotive engineer for issue of modification plate
- GVM orders must be submitted via the GVM Portal

### GVM UPGRADE KIT CONTENTS

Shock Absorbers	Leaf Springs	Greasable Shackles and Pins	SSM Compliance Plate (pre reg. only)
Strut Shock Absorbers	U-Bolts	Brake Hose Extension Bracket	GVM Stickers
Coil Springs	Polyurethane Spring Bushes	Tyre Placard	

# GVM Upgrades

Product Description

Part No.

Retail  
ea Inc GST

## GVM UPGRADE TO SUIT ISUZU D-MAX

2012 TO 7/2019 - (PAGE 102 & 105)

	Front Axle Rating	Rear Axle Rating	Gross Vehicle Mass (GVM)	Gross Combined Mass (GCM)	Towing Capacity (Braked)
<b>Original Equipment (OE)</b>	1350kg	1870kg	2950kg - 3050kg	5950kg	3500kg
<b>Ironman 4x4</b>	1500kg	2000kg	3500kg	5950kg	3500kg

*These figures are presented as a guide only. Always refer to the owner's manual for load ratings specific to the vehicle*

### POST REGISTRATION - 3500KG

### Additional Payload

Foam Cell - Temporary Load	up to 550kg	<b>HOLD021CKF1GVM1</b>	\$3312.15
Foam Cell - Permanent Load	up to 550kg	<b>HOLD021DKF1GVM1</b>	\$3312.15
Foam Cell Pro - Temporary Load	up to 550kg	<b>HOLD021CKP1GVM1</b>	\$3730.33
Foam Cell Pro - Permanent Load	up to 550kg	<b>HOLD021DKP1GVM1</b>	\$3730.33

Federal Approval CPA49748 - OE Approval No. 43971

- Only available through authorised Ironman 4x4 GVM upgrade installers
- Plus engineering sign off (Post Registration Only)
- Post Registration, State Approval - Vehicle must be inspected and approved by state authorised automotive engineer for issue of modification plate
- GVM orders must be submitted via the GVM Portal

### GVM UPGRADE KIT CONTENTS

Shock Absorbers	Leaf Springs	Greasable Shackles and Pins	GVM Stickers
Strut Shock Absorbers	U-Bolts	Brake Hose Extension Bracket	
Coil Springs	Polyurethane Spring Bushes	Tyre Placard	

## GVM UPGRADE TO SUIT MAZDA BT50

**6/2020 - (PAGE 148)**

	Front Axle Rating	Rear Axle Rating	Gross Vehicle Mass (GVM)	Gross Combined Mass (GCM)	Towing Capacity (Braked)
<b>Original Equipment (OE)</b>	1450kg	1910kg	3100kg	5950kg	3500kg
<b>Ironman 4x4</b>	1500kg	2000kg	3500kg	5950kg	3500kg

*These figures are presented as a guide only. Always refer to the owner's manual for load ratings specific to the vehicle*

**PRE REGISTRATION - 3500KG**

## Additional Payload

Foam Cell - Temporary Load	up to 500kg	<b>HOLD021CKF3GVM</b>	\$3312.15
Foam Cell - Permanent Load	up to 500kg	<b>HOLD021DKF3GVM</b>	\$3312.15
Foam Cell Pro - Temporary Load	up to 500kg	<b>HOLD021CKP3GVM</b>	\$3730.33
Foam Cell Pro - Permanent Load	up to 500kg	<b>HOLD021DKP3GVM</b>	\$3730.33

**POST REGISTRATION - 3500KG**

## Additional Payload

Foam Cell - Temporary Load	up to 500kg	<b>HOLD021CKF3GVM1</b>	\$3312.15
Foam Cell - Permanent Load	up to 500kg	<b>HOLD021DKF3GVM1</b>	\$3312.15
Foam Cell Pro - Temporary Load	up to 500kg	<b>HOLD021CKP3GVM1</b>	\$3730.33
Foam Cell Pro - Permanent Load	up to 500kg	<b>HOLD021DKP3GVM1</b>	\$3730.33

*Federal Approval 51465 - OE Approval No. 50871*

- Only available through authorised Ironman 4x4 GVM upgrade installers
- Plus engineering sign off (Post Registration Only)
- Post Registration, State Approval - Vehicle must be inspected and approved by state authorised automotive engineer for issue of modification plate
- GVM orders must be submitted via the GVM Portal

### GVM UPGRADE KIT CONTENTS

Shock Absorbers	Leaf Springs	Greasable Shackles and Pins	SSM Compliance Plate (pre reg. only)
Strut Shock Absorbers	U-Bolts	Brake Hose Relocation Kit	GVM Stickers
Coil Springs	Polyurethane Spring Bushes	Tyre Placard	



# GVM Upgrades

Product Description

Part No.

Retail  
ea Inc GST

## GVM UPGRADE TO SUIT SUZUKI JIMNY

GJ 2018+ - (PAGE 255)

	Front Axle Rating	Rear Axle Rating	Gross Vehicle Mass (GVM)	Gross Combined Mass (GCM)	Towing Capacity (Braked)
<b>Original Equipment (OE)</b>	680kg	880kg	1435kg	2735kg	1300kg
<b>Ironman 4x4</b>	800kg	1100kg	1785kg	2735kg	1300kg

*These figures are presented as a guide only. Always refer to the owner's manual for load ratings specific to the vehicle*

### PRE REGISTRATION - 1785KG

#### Additional Payload

Nitro Gas - Temporary Load	up to 350kg	<b>SUZ010BKGGVM</b>	\$2475.80
Nitro Gas - Permanent Load	up to 350kg	<b>SUZ010CKGGVM</b>	\$2475.80

### POST REGISTRATION - 1785KG

#### Additional Payload

Nitro Gas - Temporary Load	up to 350kg	<b>SUZ010BKGGVM1</b>	\$2475.80
Nitro Gas - Permanent Load	up to 350kg	<b>SUZ010CKGGVM1</b>	\$2475.80

Federal Approval CPA50688 - OE Approval No. 49434

- Only available through authorised Ironman 4x4 GVM upgrade installers
- Plus engineering sign off (Post Registration Only)
- Post Registration, State Approval - Vehicle must be inspected and approved by state authorised automotive engineer for issue of modification plate
- GVM orders must be submitted via the GVM Portal

## GVM UPGRADE KIT CONTENTS

Shock Absorbers	Offset Bush Kit Rubber	Tyre Placard
Coil Springs	Extended Brake Hose	SSM Compliance Plate (pre reg. only)
Front Crossmember Drop Brackets	Extended Headlight Sensor Bracket	GVM Stickers

## GVM UPGRADE TO SUIT TOYOTA HILUX

**2015+ - (PAGE 280 & 284)**

	Front Axle Rating	Rear Axle Rating	Gross Vehicle Mass (GVM)	Gross Combined Mass (GCM)	Towing Capacity (Braked)
<b>Original Equipment (OE)</b>	1450kg	1700kg	3050kg	5850kg	3500kg
<b>Ironman 4x4 (3500kg)</b>	1510kg	2000kg	3500kg	5850kg	3500kg
<b>Ironman 4x4 (3510kg)</b>	1510kg	2000kg	3510kg	5850kg	3500kg

*These figures are presented as a guide only. Always refer to the owner's manual for load ratings specific to the vehicle*

**PRE REGISTRATION - 3500KG**
**Additional Payload**

Foam Cell - Temporary Load	up to 500kg	<b>TOY077CKF1GVM</b>	\$3220.81
Foam Cell - Permanent Load	up to 500kg	<b>TOY077DKF1GVM</b>	\$3220.81
Foam Cell Pro - Temporary Load	up to 500kg	<b>TOY077CKP1GVM</b>	\$3769.66
Foam Cell Pro - Permanent Load	up to 500kg	<b>TOY077DKP1GVM</b>	\$3769.66

**POST REGISTRATION - 3500KG**
**Additional Payload**

Foam Cell - Temporary Load	up to 500kg	<b>TOY077CKF1GVM1</b>	\$3220.81
Foam Cell - Permanent Load	up to 500kg	<b>TOY077DKF1GVM1</b>	\$3220.81
Foam Cell Pro - Temporary Load	up to 500kg	<b>TOY077CKP1GVM1</b>	\$3769.66
Foam Cell Pro - Permanent Load	up to 500kg	<b>TOY077DKP1GVM1</b>	\$3769.66

*Federal Approval CPA50749 - OE Approval No. 47341*

**PRE REGISTRATION - 3510KG**
**Additional Payload**

Foam Cell - Temporary Load	up to 510kg	<b>TOY077CKFGVM</b>	\$3312.14
Foam Cell - Permanent Load	up to 510kg	<b>TOY077DKFGVM</b>	\$3312.14
Foam Cell Pro - Temporary Load	up to 510kg	<b>TOY077CKPGVM</b>	\$3860.99
Foam Cell Pro - Permanent Load	up to 510kg	<b>TOY077DKPGVM</b>	\$3860.99

**POST REGISTRATION - 3510KG**
**Additional Payload**

Foam Cell - Temporary Load	up to 510kg	<b>TOY077CKFGVM1</b>	\$3312.14
Foam Cell - Permanent Load	up to 510kg	<b>TOY077DKFGVM1</b>	\$3312.14
Foam Cell Pro - Temporary Load	up to 510kg	<b>TOY077CKPGVM1</b>	\$3860.99
Foam Cell Pro - Permanent Load	up to 510kg	<b>TOY077DKPGVM1</b>	\$3860.99

*Federal Approval CPA48310 (3510kg GVM) - OE Approval No. 47341*

*Federal Approval CPA50749 (3500kg GVM) - OE Approval No. 47341*

- Only available through authorised Ironman 4x4 GVM upgrade installers
- Plus engineering sign off (Post Registration Only)
- Post Registration, State Approval - Vehicle must be inspected and approved by state authorised automotive engineer for issue of modification plate
- GVM orders must be submitted via the GVM Portal

### GVM UPGRADE KIT CONTENTS

Shock Absorbers	Leaf Springs	Greasable Shackles	Tyre Placard
Strut Shock Absorbers	U-Bolts	Non-Greasable Pin Kit	SSM Compliance Plate (pre reg. only)
Coil Springs	Polyurethane Spring Bushes	Cat. 6 Side Indicators (3510kg only)	GVM Stickers

# GVM Upgrades

Product Description

Part No.

Retail  
ea Inc GST

## GVM UPGRADE TO SUIT TOYOTA HILUX

### 2005 TO 2015 - (PAGE 287)

	Front Axle Rating	Rear Axle Rating	Gross Vehicle Mass (GVM)	Gross Combined Mass (GCM)	Towing Capacity (Braked)
<b>Original Equipment (OE)</b>	1240kg - 1340kg <sup>1</sup>	1520kg - 1600kg <sup>2</sup>	2850kg	4600kg - 4750kg <sup>3</sup>	3200kg
<b>Ironman 4x4</b>	1540kg	1810kg	3350kg	4600kg - 4750kg <sup>3</sup>	3200kg

<sup>1</sup> Front axle updated 4 times

<sup>2</sup> Single Cab and Double Cab 1600kg, Extra Cab 1520kg

<sup>3</sup> 1GR-FE 4750kg, 2TR-FE 4600kg

These figures are presented as a guide only. Always refer to the owner's manual for load ratings specific to the vehicle

#### POST REGISTRATION - 3350KG

#### Additional Payload

Foam Cell - Temporary Load	up to 500kg	<b>TOY057CKFGVM1</b>	\$3138.94
Foam Cell - Permanent Load	up to 500kg	<b>TOY057DKFGVM1</b>	\$3138.94
Foam Cell Pro - Temporary Load	up to 500kg	<b>TOY057CKPGVM1</b>	\$3648.59
Foam Cell Pro - Permanent Load	up to 500kg	<b>TOY057DKPGVM1</b>	\$3648.59

Federal Approval - CPA44780 - OE Approval No. 33886

- Only available through authorised Ironman 4x4 GVM upgrade installers
- Plus engineering sign off (Post Registration Only)
- Post Registration, State Approval - Vehicle must be inspected and approved by state authorised automotive engineer for issue of modification plate
- GVM orders must be submitted via the GVM Portal

#### GVM UPGRADE KIT CONTENTS

Shock Absorbers	Leaf Springs	Greasable Shackles and Pins
Strut Shock Absorbers	U-Bolts	Tyre Placard
Coil Springs	Polyurethane Spring Bushes	GVM Stickers

Product Description

Part No.

Retail  
ea Inc GST

## GVM UPGRADE TO SUIT TOYOTA LANDCRUISER

### 200 SERIES MC / NA 2007+ - (PAGE 296)

	Front Axle Rating	Rear Axle Rating	Gross Vehicle Mass (GVM)	Gross Combined Mass (GCM)	Towing Capacity (Braked)
<b>Original Equipment (OE)</b>	1630kg <sup>1</sup> 1700kg <sup>1</sup>	1950kg	3300kg <sup>2</sup> 3350kg <sup>2</sup>	6850kg	3500kg 3550kg
<b>Ironman 4x4</b>	1800kg	2250kg	3580kg 4000kg	6850kg	3500kg 3550kg

<sup>1</sup> Front axle upgraded January 2012

<sup>2</sup> GVM upgraded January 2012

These figures are presented as a guide only. Always refer to the owner's manual for load ratings specific to the vehicle

#### PRE REGISTRATION - 4000KG

#### Additional Payload

Foam Cell Pro - MC Compliance	up to 700kg	<b>TOY063CKPGVM-MC</b>	\$2859.28
Foam Cell Pro - NA Compliance	up to 700kg	<b>TOY063CKPGVM-NB1</b>	\$3040.78

Federal Approval - (MC) CPA50517 and (NB1) CPA50503 - OE Approval No. MC-38469 and NA-43656

#### POST REGISTRATION - 4000KG

#### Additional Payload

Foam Cell Pro - MC Compliance	up to 700kg	<b>TOY063CKPGVM1-MC</b>	\$2859.28
Foam Cell Pro - NA Compliance	up to 700kg	<b>TOY063CKPGVM1-NB1</b>	\$3040.78

Federal Approval - (MC) CPA50517 and (NB1) CPA50503 - OE Approval No. MC-38469 and NA-43656

#### POST REGISTRATION - 3580KG

#### Additional Payload

Foam Cell Pro - Temporary Load	up to 280kg	<b>TOY063BKPGVM1</b>	\$2599.35
--------------------------------	-------------	----------------------	-----------

• Only available through authorised Ironman 4x4 GVM upgrade installers

• Plus engineering sign off (Post Registration Only)

• Post Registration, State Approval - Vehicle must be inspected and approved by state authorised automotive engineer for issue of modification plate

• Upgrades NA vehicles to NB1 category (fitment of Cat. 6 side indicator lamps required)

• GVM orders must be submitted via the GVM Portal

### GVM UPGRADE KIT CONTENTS

Shock Absorbers	Coil Springs	Tyre Placard	GVM Stickers
Strut Shock Absorbers	Cat. 6 Side Indicators (NA-NB1 vehicles only)	SSM Compliance Plate (pre reg. only)	

# GVM Upgrades

Product Description

Part No.

Retail  
ea Inc GST

## GVM UPGRADE TO SUIT TOYOTA LANDCRUISER

### 79 SERIES SINGLE CAB 2007+ - (PAGE 309)

	Front Axle Rating	Rear Axle Rating	Gross Vehicle Mass (GVM)	Gross Combined Mass (GCM)	Towing Capacity (Braked)
<b>Original Equipment (OE)</b>	1480kg	2300kg	3400kg	6900kg	3500kg
<b>Ironman 4x4</b>	1550kg	2800kg	3900kg	6900kg	3500kg

*These figures are presented as a guide only. Always refer to the owner's manual for load ratings specific to the vehicle*

#### PRE REGISTRATION - 3900KG

#### Additional Payload

Foam Cell - Temporary Load	up to 600kg	<b>TOY047CKFGVM</b>	\$3648.59
Foam Cell - Frequent Load	up to 600kg	<b>TOY047DKFGVM</b>	\$3727.00
Foam Cell - Permanent Load	up to 600kg	<b>TOY047EKFGVM</b>	\$3753.13
Foam Cell Pro - Temporary Load	up to 600kg	<b>TOY047CKPGVM</b>	\$3791.03
Foam Cell Pro - Frequent Load	up to 600kg	<b>TOY047DKPGVM</b>	\$3869.44
Foam Cell Pro - Permanent Load	up to 600kg	<b>TOY047EKPGVM</b>	\$3895.58

#### POST REGISTRATION - 3900KG

#### Additional Payload

Foam Cell - Temporary Load	up to 600kg	<b>TOY047CKFGVM1</b>	\$3648.59
Foam Cell - Frequent Load	up to 600kg	<b>TOY047DKFGVM1</b>	\$3727.00
Foam Cell - Permanent Load	up to 600kg	<b>TOY047EKFGVM1</b>	\$3753.13
Foam Cell Pro - Temporary Load	up to 600kg	<b>TOY047CKPGVM1</b>	\$3791.03
Foam Cell Pro - Frequent Load	up to 600kg	<b>TOY047DKPGVM1</b>	\$3869.44
Foam Cell Pro - Permanent Load	up to 600kg	<b>TOY047EKPGVM1</b>	\$3895.58

*Federal Approval - CPA45466 - OE Approval No. 03477*

- Only available through authorised Ironman 4x4 GVM upgrade installers
- Plus engineering sign off (Post Registration Only)
- Post Registration, State Approval - Vehicle must be inspected and approved by state authorised automotive engineer for issue of modification plate
- GVM orders must be submitted via the GVM Portal

### GVM UPGRADE KIT CONTENTS

Shock Absorbers	U-Bolts	Extended Brake Hose	Tyre Placard
Coil Springs	Polyurethane Spring Bushes	C Washer to Suit Brake Hose	SSM Compliance Plate (pre reg. only)
Leaf Springs	Greasable Shackles and Pins	Cat. 6 Side Indicators	GVM Stickers



Product Description

Part No.

Retail  
ea Inc GST

## GVM UPGRADE TO SUIT TOYOTA LANDCRUISER

### 79 SERIES DUAL CAB 2012+ - (PAGE 312)

	Front Axle Rating	Rear Axle Rating	Gross Vehicle Mass (GVM)	Gross Combined Mass (GCM)	Towing Capacity (Braked)
<b>Original Equipment (OE)</b>	1480kg	2300kg	3300kg	6800kg	3500kg
<b>Ironman 4x4</b>	1550kg	2800kg	3900kg	6800kg	3500kg

*These figures are presented as a guide only. Always refer to the owner's manual for load ratings specific to the vehicle*

#### PRE REGISTRATION - 3900KG

#### Additional Payload

Foam Cell - Temporary Load	up to 600kg	<b>TOY047CKFGVM</b>	\$3648.59
Foam Cell - Frequent Load	up to 600kg	<b>TOY047DKFGVM</b>	\$3727.00
Foam Cell - Permanent Load	up to 600kg	<b>TOY047EKFGVM</b>	\$3753.13
Foam Cell Pro - Temporary Load	up to 600kg	<b>TOY047CKPGVM</b>	\$3791.03
Foam Cell Pro - Frequent Load	up to 600kg	<b>TOY047DKPGVM</b>	\$3869.44
Foam Cell Pro - Permanent Load	up to 600kg	<b>TOY047EKPGVM</b>	\$3895.58

#### POST REGISTRATION - 3900KG

#### Additional Payload

Foam Cell - Temporary Load	up to 600kg	<b>TOY047CKFGVM1</b>	\$3648.59
Foam Cell - Frequent Load	up to 600kg	<b>TOY047DKFGVM1</b>	\$3727.00
Foam Cell - Permanent Load	up to 600kg	<b>TOY047EKFGVM1</b>	\$3753.13
Foam Cell Pro - Temporary Load	up to 600kg	<b>TOY047CKPGVM1</b>	\$3791.03
Foam Cell Pro - Frequent Load	up to 600kg	<b>TOY047DKPGVM1</b>	\$3869.44
Foam Cell Pro - Permanent Load	up to 600kg	<b>TOY047EKPGVM1</b>	\$3895.58

*Federal Approval - CPA45466 - OE Approval No. 03477*

- Only available through authorised Ironman 4x4 GVM upgrade installers
- Plus engineering sign off (Post Registration Only)
- Post Registration, State Approval - Vehicle must be inspected and approved by state authorised automotive engineer for issue of modification plate
- GVM orders must be submitted via the GVM Portal

### GVM UPGRADE KIT CONTENTS

Shock Absorbers	U-Bolts	Extended Brake Hose	Tyre Placard
Coil Springs	Polyurethane Spring Bushes	C Washer to Suit Brake Hose	SSM Compliance Plate (pre reg. only)
Leaf Springs	Greasable Shackles and Pins	Cat. 6 Side Indicators	GVM Stickers

# GVM Upgrades

Product Description

Part No.

Retail  
ea Inc GST

## GVM UPGRADE TO SUIT TOYOTA LANDCRUISER

### 78 SERIES TROOP CARRIER 2007+ - (PAGE 316)

	Front Axle Rating	Rear Axle Rating	Gross Vehicle Mass (GVM)	Gross Combined Mass (GCM)	Towing Capacity (Braked)
<b>Original Equipment (OE)</b>	1480kg	2300kg	3300kg	6800kg	3500kg
<b>Ironman 4x4</b>	1550kg	2800kg	3900kg	6800kg	3500kg

*These figures are presented as a guide only. Always refer to the owner's manual for load ratings specific to the vehicle*

#### PRE REGISTRATION - 3900KG

#### Additional Payload

Foam Cell - Temporary Load	up to 600kg	<b>TOY047CKFGVM</b>	\$3648.59
Foam Cell - Frequent Load	up to 600kg	<b>TOY047DKFGVM</b>	\$3727.00
Foam Cell - Permanent Load	up to 600kg	<b>TOY047EKFGVM</b>	\$3753.13
Foam Cell Pro - Temporary Load	up to 600kg	<b>TOY047CKPGVM</b>	\$3791.03
Foam Cell Pro - Frequent Load	up to 600kg	<b>TOY047DKPGVM</b>	\$3869.44
Foam Cell Pro - Permanent Load	up to 600kg	<b>TOY047EKPGVM</b>	\$3895.58

#### POST REGISTRATION - 3900KG

#### Additional Payload

Foam Cell - Temporary Load	up to 600kg	<b>TOY047CKFGVM1</b>	\$3648.59
Foam Cell - Frequent Load	up to 600kg	<b>TOY047DKFGVM1</b>	\$3727.00
Foam Cell - Permanent Load	up to 600kg	<b>TOY047EKFGVM1</b>	\$3753.13
Foam Cell Pro - Temporary Load	up to 600kg	<b>TOY047CKPGVM1</b>	\$3791.03
Foam Cell Pro - Frequent Load	up to 600kg	<b>TOY047DKPGVM1</b>	\$3869.44
Foam Cell Pro - Permanent Load	up to 600kg	<b>TOY047EKPGVM1</b>	\$3895.58

*Federal Approval - CPA45466 - OE Approval No. 03477*

- Only available through authorised Ironman 4x4 GVM upgrade installers
- Plus engineering sign off (Post Registration Only)
- Post Registration, State Approval - Vehicle must be inspected and approved by state authorised automotive engineer for issue of modification plate
- GVM orders must be submitted via the GVM Portal

### GVM UPGRADE KIT CONTENTS

Shock Absorbers	U-Bolts	Extended Brake Hose	Tyre Placard
Coil Springs	Polyurethane Spring Bushes	C Washer to Suit Brake Hose	SSM Compliance Plate (pre reg. only)
Leaf Springs	Greasable Shackles and Pins	Cat. 6 Side Indicators	GVM Stickers

# ***Suspension Selection and Information***

*Effective 1 November 2021*



# Understanding Load

Suspension is not something you often see when you first look at a vehicle. But when you need it, suspension can be the single most important upgrade you make. Original equipment suspension is set up to support your vehicle for on-road conditions with a reasonable amount of weight.

When you start to add vehicle accessories, attach a trailer or caravan and increase your load, the way the suspension handles the load changes. Couple that with uneven surfaces and off-road conditions, the OEM suspension can no longer take the additional strain.

## LOAD DISTRIBUTION

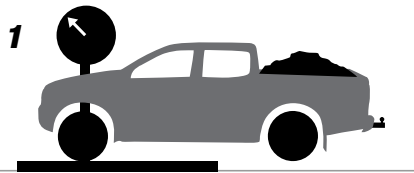

**1**  
Load placed over the front half of the vehicle determines front spring selection  
Ensure total weight does not exceed manufacturers axle load limit



**2**  
Load placed over the rear half of the vehicle determines rear spring selection  
Ensure total weight does not exceed manufacturers axle load limit



**3**  
 $1 + 2 =$  Total weight of vehicle  
Ensure total weight does not exceed manufacturers GVM (gross vehicle mass)

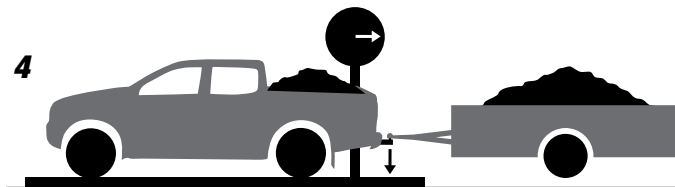

**4**  
Vehicle with trailer connected minus total weight of vehicle = Ball weight  
Ensure total weight of vehicle including ball weight does not exceed manufacturers GVM

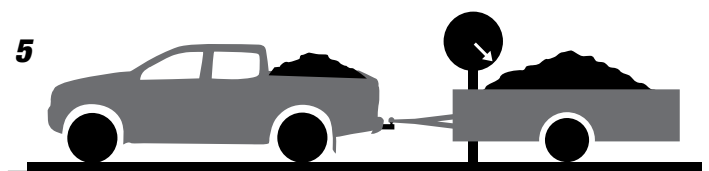

**5**  
Total weight of vehicle plus trailer weight = GCM (gross combined mass)  
Ensure total weight of vehicle and trailer does not exceed manufacturers GCM

Please note: Not all springs are available in green and some may be supplied in yellow. Please check before ordering.



# Determining Load

## STEP ONE LOAD?

When your load changes, so should your springs.

Any heavy accessories or towing load added to your vehicle, changes the handling and overall safety when driving. The vehicle's springs must be matched to the load for optimum ride height and body control. Ironman 4x4 offer a range of springs to match the additional loads whether they are constant or temporary.

When you start kitting out your vehicle, take into consideration the kerb weight and how much load you are adding, this will change what level of strength you need. Remember, you cannot exceed your GVM, but you might be able to upgrade it. (See page 363 for GVM upgrade information)

Ironman 4x4 offer a range of springs matched to cater for every load scenario. To identify your spring type, start by finding your kerb weight and add your load, permanent and temporary. How much load have you added to your vehicle?

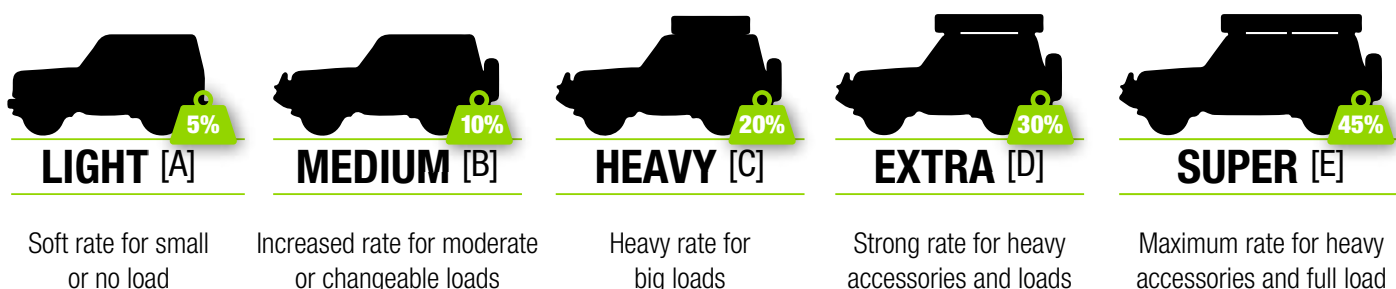

### PART NUMBER SUFFIX S - Standard Height (eg. TOY063S)

Available for selected applications to provide enhanced performance at original vehicle manufacturers ride height.

### PART NUMBER SUFFIX A - Light (eg. TOY047A)

Suitable for zero to light load applications, higher priority toward - Comfort with minimal increased ride height.

### PART NUMBER SUFFIX B - Medium (eg. TOY047B)

Suitable for use in zero to medium load applications, ideal for moderately accessorised vehicles or occasional load.

### PART NUMBER SUFFIX C - Heavy (eg. TOY047C)

Suitable for vehicles with permanent heavy accessories, higher priority towards load support, provides more control and firmer suspension.

### PART NUMBER SUFFIX D - Extra Heavy (eg. TOY047D)

Suited only to vehicles with permanent heavy accessories combined with heavy additional load.

### PART NUMBER SUFFIX E - Super Heavy (eg. TOY047E)

Maximum support for extra heavy loads typically commercial or mining use vehicles.

All lift heights quoted within this catalogue are general estimates only, relative to new vehicle ride height. Suggested lifts are based upon the lighter of the recommended additional load. The position of added weight can affect the result.



# Understanding Terrain

## STEP TWO TERRAIN?

The terrain you travel most, determines what type of shock absorber is right for you! Forces generated by a loaded vehicle in rough terrain versus a lightly loaded vehicle in smooth terrain differ greatly and can be considerably higher.

Creating safe and appropriate dynamic handling at higher than original weights requires careful consideration. The range of Ironman 4x4 shock absorbers are designed to cover all terrains and possess the correct amount of damping resistance to provide a safe and comfortable ride.

### Easy Terrain



**NITRO GAS**



#### Nitro Gas

The Nitro Gas shock is the best value for affordable performance in all common conditions.

Highly versatile, the shock is a big step up above OEM suspension in performance and control.

- 35mm piston
- 54mm body
- 16mm piston rod
- Twin tube construction
- Nitrogen gas pressurised

### Adventurous Terrain



**FOAM CELL**



#### Foam Cell

The Foam Cell shock will enhance your off-road durability and performance while still maintaining excellent on-road characteristics.

Excels in off-road conditions where heat build-up is a concern, the Foam Cell shock is larger in size and holds more oil, providing a better dissipation of heat and longer lasting performance in all terrains.

- 40mm piston
- 60mm body
- 18mm piston rod
- Twin tube construction
- Foam cell technology

### Demanding Terrain



**FOAM CELL PRO**



#### Foam Cell Pro

Foam Cell Pro shock, the premium shock, built to handle anything.

Originally designed to meet the demands of the armoured vehicle industry where reliability and durability are critical.

Foam Cell Pro is the ultimate shock when the going gets tough. Thicker and stronger than any other shock on the market, it's well suited to trades, fleet and serious off-roaders.

- 45mm piston
- 65-72mm body
- 20mm piston rod
- 3mm wall thickness
- Twin tube construction
- Foam cell technology



# Understanding Valving

## STEP THREE RIDE STYLE?

Your preferred ride style is important to know when selecting the level of valving resistance in your shock absorbers. Ironman 4x4 shock absorbers adapt to the velocity of the compression and rebound stroke which provides the right amount of control to suit your driving style.

### Comfort Valving

**GRC FEC FEC<sup>PRO</sup>**

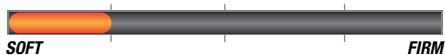
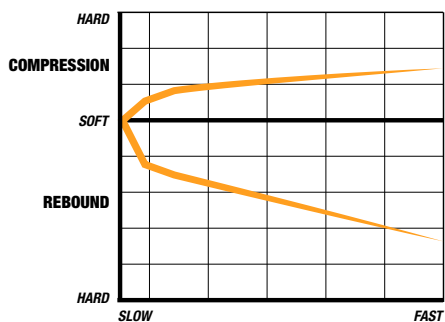

#### Soft Ride - Lightly Accessorised

The comfort range delivers smooth handling and less harshness for everyday use. Best suited to lighter vehicles without load, the shocks prioritise a soft comfortable ride, above all else.

### Performance Valving

**GR FE FE<sup>PRO</sup>**

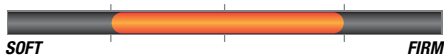
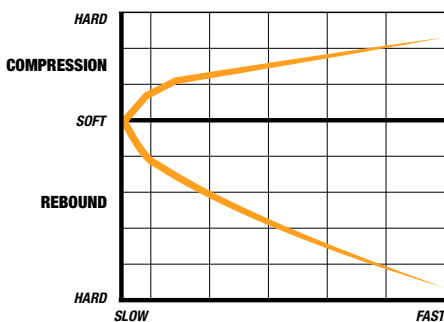

#### Versatile Ride - Moderately Accessorised

The performance range adapts to a wide range of driving styles. Best suited to moderately loaded vehicles with some accessories, the shocks provide a balanced comfortable ride with more control.

### Professional Valving

**GRP FEP FEP<sup>PRO</sup>**

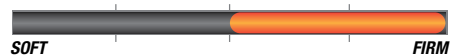
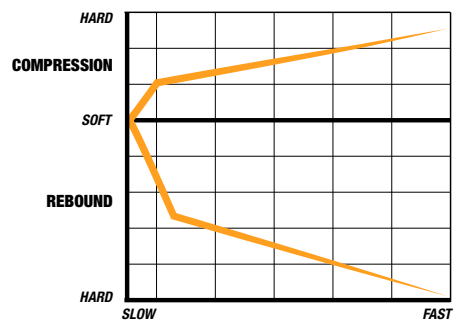

#### Strong Controlled Ride - Heavily Accessorised

The professional range controls body roll and reduces pitching while driving over all terrains. Best suited to heavily loaded vehicles with a higher centre of gravity, the shocks focus on maximising control and stability.



# Understanding GVM Upgrades

## GVM UPGRADE REQUIRED?

If loads exceed the axle limits or gross vehicle mass (GVM) stated by the original vehicle manufacturer, a certified increase in GVM will be required.





















Ironman 4x4 design and manufacture a range of approved GVM upgrades for a selection of vehicles, which comply with federal and state regulations (Australia and NZ Only). See pages 373 -386 of this catalogue.

Comprehensive testing is conducted by Ironman 4x4 and independent engineers to ensure maximum safety, performance and ADR compliance at the increased load carrying capacity.

Ironman 4x4 has obtained Second Stage Manufacturer (SSM) status through the Department of Infrastructure Regional Development and Cities in Canberra. GVM Upgrades are available through selected Ironman 4x4 Australian and NZ distributors only.

## ADDITIONAL LOAD

Use the below guide to estimate the additional load in the vehicle. Calculate the load separated over each axle to determine the nearest spring selection based on the recommendations given within the vehicle application pages. Please Note: Weights quoted below are supplied as an approximate guide only.

<b>Bull Bar</b> Aluminium  <b>+40kg</b>	<b>Fuel Tank</b> Extended Capacity  <b>+90kg</b>
<b>Bull Bar</b> Steel  <b>+60kg</b>	<b>Roof Rack</b> Steel 2200mm Tent Rack  <b>+45kg</b>
<b>Winch</b> With Synthetic Rope  <b>+25kg</b>	<b>Rooftop Tent</b> Including bedding  <b>+65kg</b>
<b>Winch</b> With Steel Cable  <b>+45kg</b>	<b>Water Tank</b> 100 Litres  <b>+100kg</b>
<b>Spare Wheel</b> Additional  <b>+50kg</b>	<b>Tray -100kg</b> Aluminium  <b>-100kg</b>
<b>Rear Bar</b> Steel  <b>+65kg</b>	<b>Tray</b> Steel  <b>+400kg</b>
<b>Canopy</b> ABS Plastic  <b>+80kg</b>	<b>Tool Box</b> Average  <b>+100kg</b>
<b>Drawer System</b> 1300mm Twin Drawers  <b>+90kg</b>	<b>Passenger</b> Average  <b>+80kg</b>
<b>Battery</b> Additional  <b>+25kg</b>	<b>Luggage</b>  <b>+100-300kg</b>
<b>Fridge</b> 50 Litre  <b>+30kg</b>	<b>Towing</b>  <b>+100-300kg</b>
	<b>Large Overhang</b> <b>+30%</b>

Vehicles with large rear overhang such as tray or service bodies may amplify loads by approximately 30%.

# Suspension Kits and Correct Selection

Ironman 4x4 suspension kits are a simplified way to select the appropriate components for a vehicle. Many vehicles have different suspension requirements according to added load, terrain and driver preferences.

To establish the correct suspension kit, we ask the following questions:

- 1) What is the primary usage of the vehicle?
- 2) What accessories are on the vehicle?
- 3) What additional loads are within the vehicle and how often are the loads present?
- 4) What is the primary driving terrain?

The Ironman 4x4 suspension kit part numbering system is designed to be read as follows:

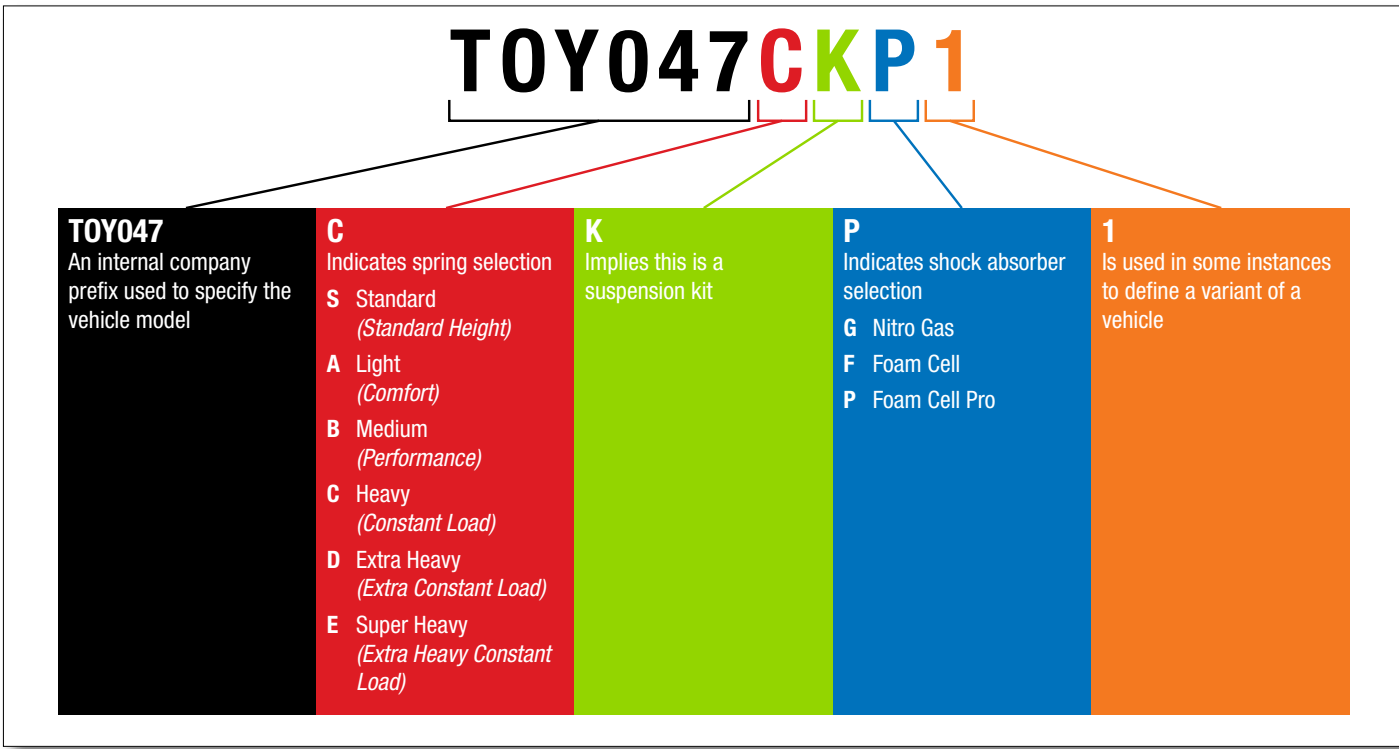

Generally, as no two vehicles are alike, customising a suspension kit is recommended and can be discussed with the Ironman 4x4 team.

For example, a vehicle with heavy load over the rear axle only, does not require constant load front springs, in this case a lighter front spring and heavier rear spring is the best choice.

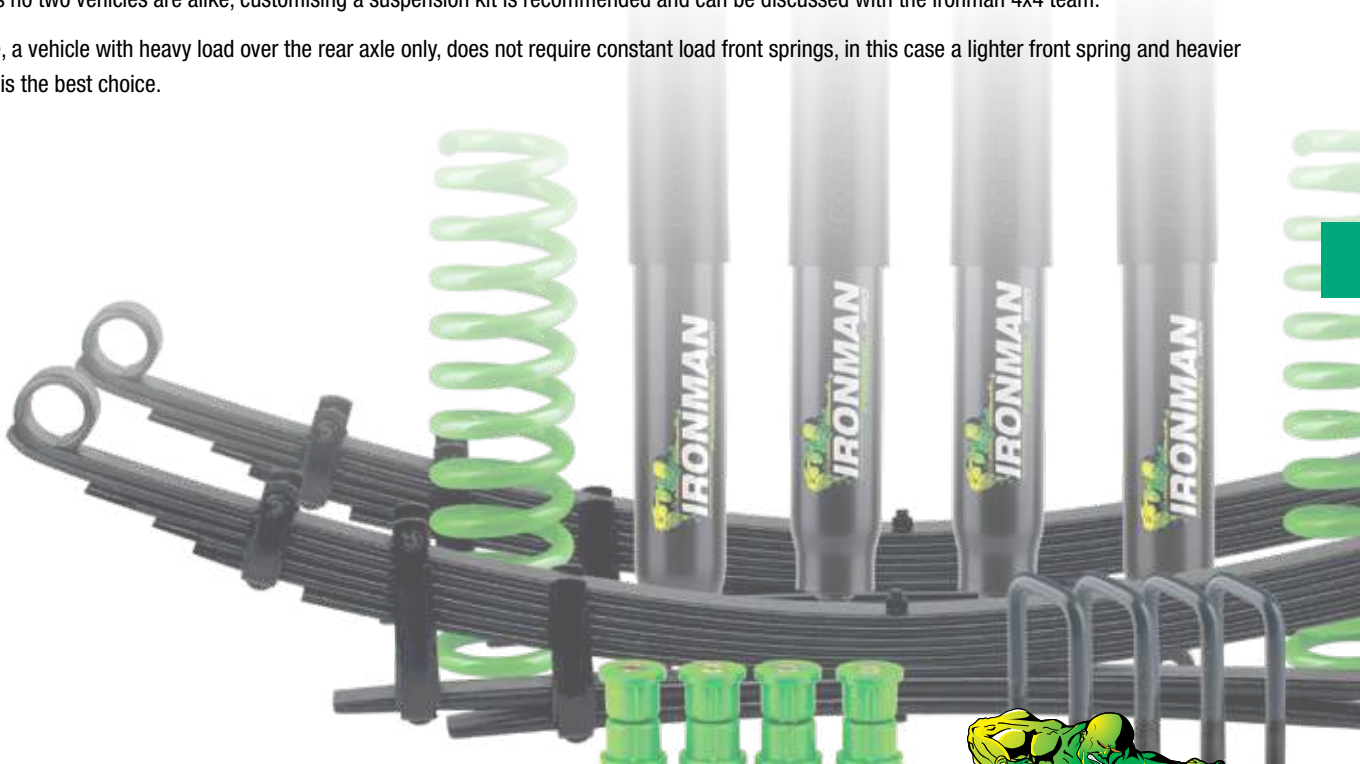



# Application Guide - Shock Absorbers To Suit

To Suit Make	To Suit Model	Year	Nitro Gas		Foam Cell		Foam Cell Pro	
			Front	Rear	Front	Rear	Front	Rear
<b>TO SUIT FIAT</b>	Fullback	2016+	12715GR	12729GR /C /P	24715FE	24729FE /C /P		
<b>TO SUIT FORD</b>	Courier / Ranger	1985 - 2011	12667GR	12095GR /C	24667FE	24095FE /C /P	45667FE	45095FE /C /P
	Ranger T6 PX / PXII	2011 - 6/2018	12727GR	12095GR /C	24727FE	24095FE /C /P	45727FE	45095FE /C /P
	Ranger PXIII (Not US Model)	7/2018+	12827GR	12095GR /C	24827FE	24095FE /C /P	45827FE	45095FE /C /P
	Everest UA	2015 - 6/2018	12727GR	12732GR	24727FE	24732FE	45727FE	45732FE
	Everest UA II	7/2018+	12827GR	12732GR	24827FE	24732FE	45827FE	45732FE
<b>TO SUIT GMC</b>	Suburban, Tahoe, Sierra, Yukon, Avalanche, Silverado	2007 - 2013	12807GR	12808GR				
	Suburban, Escalade, Tahoe, Sierra, Yukon, Silverado	2014 - 2016	12809GR	12810GR				
<b>TO SUIT HAVAL</b>	H9 Wagon	8/2017+	12710GR	12804GR	24710FE	24804FE		
<b>TO SUIT HOLDEN / GM</b>	Frontera	1995 - 1/1999	12667GR	12644GR	24667FE	24644FE		
	Rodeo KB - TF	1983 - 1988	12087GR	12636GR /C /P	24087FE	24636FE /C /P		
	Rodeo KB - TFS	1988 - 3/2003	12643GR	12636GR /C /P		24636FE /C /P		
	Rodeo / Colorado / RA / RA7 / RC	2003 - 2012	12667GR	12636GR /C /P	24667FE	24636FE /C /P		
	Colorado	2012 - 2020	12745GR	12636GR /C /P	24745FE	24636FE /C /P	45745FE	45636FE /C /P
	Colorado 7 / Trailblazer	2012+	12745GR	12746GR /C	24745FE	24746GR /C	45745FE	45746FE /C
	Jackaroo	Pre 1986	12087GR	12636GR /C	24087FE	24636FE /C		
	Jackaroo	11/1986 - 1991	12087GR	12671GR	24087FE			
	Jackaroo / Bighorn / Monterey	1992+	12643GR	12644GR	24643FE	24644FE		
<b>TO SUIT HYUNDAI</b>	Terracan	2001+	12087GR	12637GR /C	24087FE			
<b>TO SUIT ISUZU</b>	D-Max	2003 - 2012	12667GR	12636GR /C /P	24667FE	24636FE /C /P		
	D-Max Low Ride 2WD	2012+	12797GR	12636GR /C /P		24636FE /C /P		
	D-Max	6/2012 - 7/2019	12745GR	12636GR /C /P	24745FE	24636FE /C /P	45745FE	45636FE /C /P
	D-Max	8/2019+	12845GR	12698GR /C /P	24845FE	24698FE /C /P	45845FE	45698FE /C /P
	MU-X	2013+	12745GR	12746GR /C	24745FE	24746GR /C	45745FE	45746FE /C
	Trooper	Pre 1986	12087GR	12636GR /C	24087FE	24636FE /C		
	Trooper	11/1986 - 1991	12087GR	12671GR	24087FE			
	Monterey	1992+	12643GR	12644GR	24643FE	24644FE		
<b>TO SUIT JEEP</b>	Cherokee XJ	1984+	12665GR	12666GR	24665FE	24666FE		
	Cherokee Liberty KJ / KK	2001 - 2012	12711GR	12712GR				
	Gladiator	5/2020+	12851GR /C				45851FE /C	45854FE /C
	Grand Cherokee ZJ / ZG	1993 - 1998	12665GR	12670GR	24665FE			
	Grand Cherokee WJ / WG	1999 - 6/2005	12774GR	12775GR				
	Grand Cherokee WK2	2011-2016	12735GR					
	Grand Cherokee WK2	2016+	12738GR LH 12738GR RH					
	Wrangler TJ	1996 - 2/2007	12665GR	12669GR	24665FE			
	Wrangler JK	2006+	12751GR	12752GR			45751FE	45752FE
	Wrangler JK 4" Lift	2006+	12751LGR	12752LGR			45751LFE	45752LFE
	Wrangler JL	2018+	12851GR /C	12852GR /C			45851FE /C	45852FE /C
<b>TO SUIT JMC</b>	Vigus	2014+	12710GR	12650GR /C	24710FE	24650FE /C /P	45710FE	45650FE /C /P

/C = Comfort option available. /P = Professional option available. <sup>1</sup> Bundera / Wrangler LHS <sup>2</sup> Bundera / Wrangler RHS <sup>3</sup> 45780FE, Must use Ironman coil springs TOY063





# Application Guide - Shock Absorbers To Suit

To Suit Make	To Suit Model	Year	Nitro Gas		Foam Cell		Foam Cell Pro	
			Front	Rear	Front	Rear	Front	Rear
<b>TO SUIT LAND ROVER</b>	Defender 90 / 110 / 130 Series		12080GR	12640GR	24080FE	24640FE	45080FE	45640FE
	Range Rover (Coil Springs)	1971 - 1995	12080GR	12640GR	24080FE	24640FE	45080FE	45640FE
	Discovery Series 1	1989 - 1998	12080GR	12640GR	24080FE	24640FE	45080FE	45640FE
	Discovery Series 2 (Coil Springs)	1999 - 2005	12776GR	12777GR	24776FE	24777FE		
<b>TO SUIT LDV</b>	T60	2017+	12745GR	12636GR /C /P	24745FE	24636FE /C /P	45745FE	45636FE /C /P
<b>TO SUIT MAHINDRA</b>	Scorpio Getaway Pik-Up / Wagon	2002 - 2012	12087GR	12749GR				
	Scorpio Getaway Pik-Up	2012 +	12087GR	12731GR				
<b>TO SUIT MAZDA</b>	B Series Bravo / BT50	1987 - 2011	12667GR	12095GR /C	24667FE	24095FE /C /P	45667FE	45095FE /C /P
	BT50	2011 - 5/2020	12727GR	12095GR /C	24727FE	24095FE /C /P	45727FE	45095FE /C /P
	BT50	6/2020+	12845GR	12698GR /C /P	24845FE	24698FE /C /P	45845FE	45698FE /C /P
<b>TO SUIT MERCEDES-BENZ</b>	G-Wagen W460, W461, W463	1979+	12811GR	12812GR	24811FE	24812FE		
	G-Wagen G55 AMG				24788FE	24789FE		
	Unimog (6 Bolt Axle)						45803FE	45803FE
	Unimog (10 Bolt Axle)						45802FE	45802FE
	X-Class	2017 - 5/2020	12716GR	12728GR	24716FE	24728FE /P	45716FE	45728FE /C /P
<b>TO SUIT MITSUBISHI</b>	Triton / L200	Pre 1993	12082GR	12636GR /C /P	24082FE	24636FE /C /P		
	Triton ME-MJ / L200	1993 - 1996	12082GR	12636GR /C /P	24082FE	24636FE /C /P		
	Triton MK / L200	1996 - 2006	12087GR	12698GR /C /P	24087FE	24698FE /C /P		
	Triton ML-MN / L200	2006 - 2015	12715GR	12636GR /C /P	24715FE	24636FE /C /P		
	Triton MQ-MR / L200	2015 - 10/2018	12715GR	12729GR /C /P	24715FE	24729FE /C /P		
	Pajero / Montero NA-NG (Leaf)	Pre 1991	12082GR	12636GR /C /P	24082FE	24636FE /C /P		
	Pajero / Montero NA-NG (Coil)	1988 - 1991	12082GR	12645GR /C	24082FE	24645FE /C		
	Pajero / Montero NH-NL (Leaf)	1991 - 1999	12087GR	12636GR /C /P	24087FE	24636FE /C /P		
	Pajero / Montero NH-NL (Coil)	6/1991 - 2000	12087GR	12646GR	24087FE	24646FE		
	Pajero / Montero NM-NX	2000+	12713GR	12714GR	24713FE			
	Challenger / Montero Sport PA (Leaf)	1998 - 2006	12087GR	12636GR /C /P	24087FE	24636FE /C /P		
	Challenger / Montero Sport PA (Coil)	1998 - 2008	12087GR	12645GR /C	24087FE	24645FE /C		
	Challenger / Pajero Sport / Montero Sport / Dakar PB	2009 - 2015	12715GR	12645GRS	24715FE	24645FES		
	Pajero Sport / Montero Sport	2015+	12715GR	12645GRS	24715FE	24645FES		
	Delica L400 Without ECS	1994+	12667GR	12698GR	24667FE			
	Delica L400 With ECS	1994+	12667GR	12671GR	24667FE			
<b>TO SUIT NISSAN</b>	Patrol MQ / MK G160	Pre 1988	12075GR	12076GR				
	Patrol GQ / GU SWB & LWB Wagon	1988 - 1998	12091GR	12094GR	24091FE	24094FE /P	45091FE /P	45094FE /P
	Patrol GQ / GU SWB & LWB Wagon 4" Lift				24091LFE	24094LFE /P	45091LFE /P	45094LFE /P
	Patrol GQ / GU SWB & LWB Wagon 6" Lift				24091LFE1	24094LFE1	45091LFE1	45094LFE1
	Patrol GQ Y60 Cab Chassis (Leaf)		12661GR	12648GR	24661FE	24648FE	45661FE	45648FE
	Patrol GU Y61 Cab Chassis (Leaf)		12091GR	12648GR	24091FE	24648FE	45091FE /P	45648FE
	Patrol GU Y61 Cab Chassis (Coil)		12091GR	12094GR	24091FE	24094FE /P	45091FE /P	45094FE /P
	Patrol GU Y61 Cab Chassis (Coil) 4" Lift				24091LFE	24094LFE /P	45091LFE /P	45094LFE /P
	Patrol GU Y61 Cab Chassis (Coil) 6" Lift				24091LFE1	24094LFE1	45091LFE1	45094LFE1

/C = Comfort option available. /P = Professional option available. <sup>1</sup> Bundera / Wrangler LHS <sup>2</sup> Bundera / Wrangler RHS <sup>3</sup> 45780FE, Must use Ironman coil springs TOY063



# Application Guide - Shock Absorbers To Suit

To Suit Make	To Suit Model	Year	Nitro Gas		Foam Cell		Foam Cell Pro	
			Front	Rear	Front	Rear	Front	Rear
<b>TO SUIT NISSAN</b>	Patrol Y62	2009+	12740GR	12742GR	24740FE	24742FE	45740FE	45742FE
	Pathfinder / Terrano / II / R20 / WD21	Pre 1995	12667GR	12636GR /C /P	24667FE	24636FE /C /P		
	Pathfinder R51	7/2005+	12716GR	12718GR	24716FE	24718FE		
	Navara D21	1985 - 1996	12087GR	12636GR /C /P	24087FE	24636FE /C /P		
	Navara D22 / NP300 (Torsion Bar)	1997+	12791GR	12636GR /C /P				
	Navara D40 / Xterra	2005+	12716GR	12717GR	24716FE	24717FE /P	45716FE	45717FE /P
	Navara NP300 (Leaf)	2014+	12716GR	12698GR /C	24716FE	24698FE /C /P	45716FE	45698FE /C /P
	Navara NP300 (Coil)	2015+	12716GR	12728GR	24716FE	24728FE /P	45716FE	45728FE /C /P
	Paladin	Pre 2005	12791GR	12698GR /C		24698FE /C /P		
<b>TO SUIT RAM</b>	1500 DS	2014+					45855FE	45856FE /C
	1500 DT	6/2018+					45860FE	45862FE /C
<b>TO SUIT RENAULT / DACIA</b>	Duster	2010+	12747GR	12748GR				
	Alaskan	2017+	12716GR	12728GR	24716FE	24728FE /P	45716FE	45728FE /C /P
<b>TO SUIT SSANGYONG</b>	Musso Q200 SWB	10/2018+	12823GR	12824GR				
	Musso Q201 LWB (Coil)	10/2018+	12823GR	12825GR				
	Musso Q201 / Q205 LWB (Leaf)	10/2018+	12823GR	12826GR				
	Musso / Korando	1996 - 2006	12667GR	12661GRS	24667FE	24661FES		
	Rexton Y400	2018+	12823GR	12828GR				
<b>TO SUIT SUBARU</b>	Forester - See pages 238 / 239 for listing							
	Outback - See page 240 for listing							
	XV - See page 241 for listing							
<b>TO SUIT SUZUKI</b>	Jimny SN413 / GJ	1998+	12759GR	12760GR				
	Sierra / Samurai LJ / SJ (Leaf)	1981+	12085GR	12086GR				
	Vitara SWB	1988+	12083GR	12089GR				
	Vitara LWB	1988+	12083GR	12658GR				
	Grand Vitara SWB	1988 - 7/2005	12083GR	12089GR				
	Grand Vitara LWB	1988 - 7/2005	12083GR	12658GR				
	Grand Vitara	8/2005 - 2015	12721GR	12722GR				
<b>TO SUIT TOYOTA</b>	4Runner Gen 1, N60 (Leaf)	1988 - 1997	12088GR	12650GR /C	24088FE	24650FE /C /P		
	4Runner / Surf Gen 2, N130 V6 (Coil)	1990 - 1997	12088GR	12637GR /C	24088FE	24637FE /C		
	4Runner Gen 3, N180-N185	1996 - 2002	12691GR	12661GR	24691FE	24661FE	45691FE	45661FE
	4Runner Gen 4 & 5, N210-N280	2003+	12710GR	12682GR /C /P	24710FE	24682FEC /P	45710FE	45682FEC /P
	FJ Cruiser	2006+	12710GR	12682GR /C /P	24710FE	24682FE /C /P	45710FE	45682FE /C /P
	Fortuner	2004 - 2015	12710GR	12743GR /C	24710FE	24743FE /C	45710FE	45743FE /C
	Fortuner	2015+	12730GR	12743GR /C	24730FE	24743FE /C	45730FE	45743FE /C
	Hiace Series 200	2005 - 2019	12667GR	12805GR	24667FE	24805FE		
	Hiace Series 300	2019+			24840FE	24842FE /C		
	Hilux Solid Front Axle	1979 - 10/1983	12639GR /C	12636GR /C /P	24639FE	24636FE /C /P		
	Hilux Solid Front Axle	11/1983 - 11/1997	12639GR /C	12650GR /C	24639FE	24650FE /C /P		
	Hilux / Tiger / 107 / 108 / 110 / 111 / 167	1997 - 2005	12088GR	12081GR /C	24088FE	24081FE /C /P		

/C = Comfort option available. /P = Professional option available. <sup>1</sup> Bundera / Wrangler LHS <sup>2</sup> Bundera / Wrangler RHS <sup>3</sup> 45780FE, Must use Ironman coil springs TOY063



# Application Guide - Shock Absorbers To Suit

To Suit Make	To Suit Model	Year	Nitro Gas		Foam Cell		Foam Cell Pro	
			Front	Rear	Front	Rear	Front	Rear
<b>TO SUIT TOYOTA</b>	Hilux Low Ride 2WD	2005+	12764GR	12650GR/C	24650FE/C/P			
	Hilux / Vigo	2005 - 2015	12710GR	12650GR/C	24710FE	24650FE/C	45710FE	45650FE/C
	Hilux / Vigo Long Travel	2005 - 2015	12710GR	12081GR/C	24710FE	24081FE/C/P	45710FE	45081FE/C/P
	Hilux / Revo	2015+	12730GR	12081GR/C	24730FE	24081FE/C/P	45730FE	45081FE/C/P
	Landcruiser 40 / 42 / 45 / 46 / 47 Series	1960 - 1980	12635GR/C	12636GR/C/P	24635FE/C	24636FE/C/P	45635FE	45636FE/C/P
	Landcruiser 60 Series	Pre 1986	12637GR/C	12636GR/C/P	24637FE/C	24636FE/C/P	45637FE/C	45636FE/C/P
	Landcruiser 60 Series	1986+	12637GR/C	12650GR/C	24637FE/C	24650FE/C/P	45637FE/C	45650FE/C/P
	Landcruiser 70 / 73 / 74 Series (Leaf/Leaf)	1984 - 1988	12637GR/C	12650GR/C	24637FE/C	24650FE/C/P	45637FE/C	45650FE/C/P
	Bundera	1984 - 1989	12091GR	12639GRS <sup>1</sup> 12650GR <sup>2</sup>	24091FE	24639FES <sup>1</sup> 24650FE <sup>2</sup>		
	Landcruiser II / Prado 70 / 73 / 78 Series	1990 - 1996	12696GR	12697GR	24696FE	24697FE		
	Landcruiser 71 Series (Coil/Leaf)	1991+	12091GR	12081GR/C	24091FE	24081FE/C/P	45091FE/P	45081FE/C/P
	Landcruiser 75 Series	1984 - 1999	12637GR/C	12081GR/C	24637FE/C	24081FE/C/P	45637FE/C	45081FE/C/P
	Landcruiser 76 / 78 / 79 / 70 & D/Cab	2007+	12091GR	12094GR/C	24091FE	24094FE/C/P	45091FE/P	45094FE/C/P
	Landcruiser 76 / 78 / 79 / 70 & D/Cab Long Travel	2007+			24091FE	24094LFE/P	45091FE/P	45094LFE/P
	Landcruiser 80 / 105 Series	1990+	12683GR	12682GR	24683FE	24682FE	45683FE	45682FE
	Landcruiser 80 / 105 Series 4" Lift	1990+			24683LFE	24682LFE	45683LFE	45682LFE
	Landcruiser 80 / 105 Series 6" Lift	1990+			24683LFE1	24682LFE1	45683LFE1	45682LFE1
	Landcruiser 100 Series IFS	1998+	12795GR	12796GR	24795FE	24796FE	45795FE	45796FE/P
	Landcruiser 200 Series	2007+	12720GR	12796GR	24720FE	24796FE	45720FE	45796FE/P
	Prado 90 / 95 Series	1996 - 10/2002	12691GR	12661GR	24691FE	24661FE	45691FE	45661FE
	Prado 120 Series (except Grande)	4/2003 - 10/2009	12710GR	12682GR/C/P	24710FE	24682FEC/P	45710FE	45682FEC/P
	Prado 150 Series (except Kakadu)	2009-11/2017	12750GR	12682GR/C/P	24750FE	24682FEC/P	45750FE	45682FEC/P
	Prado 150 Series (except Kakadu)	12/2017+	12710GR	12682GR/C/P	24710FE	24682FEC/P	45710FE	45682FEC/P
	Tacoma	2005+	12710GR	12744GR	24710FE	24744FE	45710FE	45744FE
	Tundra	2006 - 2021			24780FE	24781FE	45780FE <sup>3</sup>	45781FE
<b>TO SUIT TROLLER</b>	T4	1997 - 6/2014	12765GR	12765GR				
	T4	7/2014+	12755GR	12755GR				
<b>TO SUIT UAZ</b>	Hunter		12652GR	12698GR	24652FE	24698FE		
	Patriot		12637GRS	12698GR	24637FES	24698FE		
<b>TO SUIT VOLKSWAGEN</b>	Amarok	2010+	12725GR	12726GR				

/C = Comfort option available. /P = Professional option available. <sup>1</sup> Bundera / Wrangler LHS <sup>2</sup> Bundera / Wrangler RHS <sup>3</sup> 45780FE, Must use Ironman coil springs TOY063



# Features and Benefits

## NITRO GAS SHOCK ABSORBERS

*Gas Pressurised shock absorber boosts performance and adapts to a wide range of driving styles*

**NITROGEN GAS PRESSURISED** - Low pressure nitrogen gas dramatically reduces the likelihood of oil aeration and shock fade.

**35mm TEFLON BANDED PISTON** - Precision shim-stack piston specifically valved by Ironman suspension engineers, banded with teflon for smooth long life operation.

**54mm TWIN TUBE BODY** - Increased oil volume for improved cooling and endurance, Twin tube construction protects internal components from rock damage.

**16mm – 18mm HARD CHROME PISTON ROD** - Hardened and polished, volumetrically balanced to piston size.

**FLEXIBLE RUBBER BUSHES** - Offers quieter operation and reduces damaging side loads from shock absorber.

**TRIPLE-LIP HIGH PRESSURE NOK SEAL** - Maximum gas and oil retention ability to withstand high displacement offroad use.

**SUPPLEMENTARY WELDED MOUNTS** - Fusion welded and supplementary welded for maximum strength and reliability.

**SINGLE PIECE BILLET EYE RINGS AND STEMS** - Ultra robust design prevents breakage or bending of mounts.

**VEHICLE SPECIFIC VALVING** - Every part number is specially valved for each vehicle application, this ensures the best possible ride and handling as intended by Ironman suspension engineers.

**LONG TRAVEL** - Suitable for standard and raised height vehicles, additional length increases wheel articulation.

**IMPACT RESISTANT STONE SHIELD** - Steel or Polyethylene dust shield protects piston rod from impacts and road debris.



**SUPPLEMENTARY WELDED MOUNTS** - Fusion welded then supplementary welded for higher strength and reliability.

**360° WELDED MOUNTS** - Fusion welded then fully welded around mounting for maximum strength and reliability.

**SINGLE PIECE BILLET EYE RINGS AND STEMS** - Ultra robust design prevents breakage or bending of mounts.

**VEHICLE SPECIFIC VALVING** - Every part number is specially valved for each vehicle application, this ensures the best possible ride and handling as intended by Ironman suspension engineers.

**LONG TRAVEL** - Suitable for standard and raised height vehicles, additional length increases wheel articulation.

**IMPACT RESISTANT STONE SHIELD** - Steel or Polyethylene dust shield protects piston rod from impacts and road debris.

## COIL SPRINGS

*Available in a wide range of load ratings to maintain optimum ride height*

**COLD COILED** - CNC cold coiling ensures perfect consistency and accuracy, less heat during manufacture maintains material properties resulting in longer life.

**BAR PEELED** - Bar peeling is the process of forming the material to an exact size before coiling, this ensures the diameter remains constant and free of flaws along its entire length.

**SHOT PEENED** - Manipulates material surface tension to reduce stress, greatly enhances spring life.

**TRIPLE SCRAGGED** - Each coil is fully compressed to a solid state 3 times to minimise coil settling.

**PROGRESSIVE AND LINEAR RATE** - Used in accordance to original vehicle manufacturers preference, progressive springs increase rate as the spring compresses, linear springs maintain a consistent rate throughout its range.

**POWDERCOATED** - All springs are electro-static powdercoated for a durable finish.



## FOAM CELL SHOCK ABSORBERS

*Premium shock absorber for superior endurance in all conditions*

**FOAM CELL TECHNOLOGY** - Micro-Cellular closed cell foam insert maximises cooling efficiency by occupying less internal space than gas within a pressurised shock absorber. Greater oil capacity and more surface area maintains lower operating temperatures.

**40-45mm TEFLON BANDED PISTON** - Precision shim-stack piston specifically valved by Ironman suspension engineers, banded with teflon for smooth long life operation.

**60-72mm TWIN TUBE BODY** - 50%-100% more oil volume than a gas shock absorber for superior cooling and endurance. Twin tube construction protects internal components from rock damage.

**18-20mm HARD CHROME PISTON ROD** - Hardened and polished, volumetrically balanced to piston size.

**FLEXIBLE RUBBER BUSHES** - Offers quieter operation and reduces damaging side loads from shock absorber.

**TRIPLE-LIP HIGH PRESSURE NOK SEAL** - Maximum oil retention ability to withstand high displacement offroad use.



## LEAF SPRINGS

*Available in a wide range of load ratings to maintain optimum ride height*

**INTER LEAF LINERS** - Used in some applications to lower friction between leaves reducing noise and improving - Comfort.

**LINED BOLT CLAMPS** - All Ironman springs feature bolted guide clamps for greater flex, the addition of anti-friction liners ensures noise free smooth operation.

**SHOT PEENED** - Manipulates tension side of material to reduce stress, greatly enhances spring life.

**DIAMOND CUT LEAVES** - Distributes load at the leaf tip and reduces interleaf friction.

**MILITARY WRAP** - Where applicable, an additional wrap around the leaf eye protects from failure in case of damage.



# Features and Benefits

## TORSION BARS

*Higher spring rate to support extra weight from additional vehicle accessories*

**UP-SET FORGED ENDS** - Stronger than machining alone, forging manipulates steel grain for superior strength and durability.

**PREMIUM MICRO-ALLOY STEEL** - Exceeds OEM steel grade for ultra long life and less sag.

**INCREASED BAR DIAMETER** - Higher spring rate better supports added accessories and balances front and rear suspension performance.

**X-RAY EXAMINED** - Each and every Ironman Torsion Bar is X-Ray tested to eliminate risk of breakage due to material flaw.

**DIRECTIONAL PRE-SETTING** - Torsion Bars are rotationally pre-set in their direction of installation to reduce spring settling. Each bar is marked for left or right fitment.

## POLYURETHANE BUSHES

*Provide precise spring location and enables lubrication to increase suspension flex and - Comfort*

**INJECTION MOULDED POLYURETHANE** - High density injection moulded polyurethane material ensures precise location and a durable bearing surface for your leaf springs, making them very durable in hot temperatures whilst providing a soft - Comfortable vehicle ride.

**GREASABLE** - Polyurethane bushes are greasable to aid in longer life and ensure smooth ride and quiet operation.

**SPIRAL BORE AND FLANGES** - To distribute lubricating grease evenly throughout the bushing surface when combined with greasable shackles and pins.

**SPLINES** - Allows the bush to conform to irregularities and grip to the eye surface.



## GREASABLE SHACKLES AND PINS

*Enables easy re-greasing of polyurethane spring bushes*

**QUAD-OUTLET GREASABLE** - Greasable shackles provide an easy method of re-lubricating polyurethane bushes. Chamfered Quad-Outlet ports distribute grease liberally along the bush surface.

**SERVICEABLE** - All Ironman shackles and pins feature a serviceable bolt together construction.

**ANTI-INVERSION SHACKLE** - On selected models, a third pin is positioned on the shackle to protect the spring in the case of inversion.



## CASTER CORRECTION PLATES

*Used to correct caster angle after raising suspension beyond 100mm (4")*

**PRE-CONFIGURED CASTER CORRECTION** - Fixed 5 degree offset models suit 100mm (4") to 150mm (6") lifted suspension.



## STEERING DAMPER

*Reduce unwanted vibration and feedback through steering system in rough conditions*

**FOAM CELL TECHNOLOGY** - Micro-Cellular closed cell foam insert allows for the horizontal mounting orientation required by a steering damper.

**35mm TEFLON BANDED PISTON** - Precision shim-stack piston specifically valved by Ironman suspension engineers, banded with Teflon for smooth long life operation.

**54mm TWIN TUBE BODY** - Increased oil volume improves cooling and endurance, twin tube construction protects internal components from impact damage.

**SUPPLEMENTARY WELDED MOUNTS** - Fusion welded and supplementary welded for maximum strength and reliability.

**SINGLE PIECE BILLET EYE RINGS AND STEMS** - Ultra robust design prevents breakage or bending of mounts.

**VEHICLE SPECIFIC VALVING** - Every part number is specially valved for each vehicle application, this ensures the steering operation is smooth and unhindered by the effects of rough road driving.



## CASTER CORRECTION BUSHES

*Available in adjustable or fixed offset designs, used to correct caster angle after raising suspension under 100mm (4")*

**PRE-CONFIGURED CASTER CORRECTION** - Fixed 2 degree offset models suit 50mm (2") lifted suspension.

**ADJUSTABLE CASTER CORRECTION** - Adjustable offset suit a wide range of lift heights up to 100mm (4")

**HIGH DENSITY MATERIALS** - Vehicle specific rubber or polyurethane material.



## ADJUSTABLE PANHARD RODS

*Used to correct axle shift after raising suspension. Adjustable as required to re-centralise axle to vehicle*

**COMPETITION SPEC** - 32mm solid rod used throughout.

**FINE THREAD ADJUSTMENT** - M32 x 2mm thread ensures precision adjustment for greater accuracy.

**OEM STYLE RUBBER BUSHES** - Maximum flex and durability. Replaceable OEM style bushes.



## EXTENDED SWAY BAR LINKS

*Recalibrates sway bar index after raising suspension.*

**VEHICLE SPECIFIC BOLT ON DESIGN** - Easy fitment, utilises OEM mounting locations.

**ADJUSTABLE LENGTH** - Adjustable extension where possible depending on vehicle model.

**PRACTICAL DESIGN** - Strongest construction up-spec materials to avoid bending and breaking. Rubber bushes and aircraft grade spherical bearings used where possible depending on vehicle model.





# Features and Benefits

## POLYURETHANE COIL SPRINGS SPACERS / TRIM PACKERS

Available individually to adjust "side to side" or "front to back" vehicle lean due to uneven load placement



**INJECTION MOULDED POLYURETHANE** - High density injection moulded polyurethane material ensures precise location and a durable seat with the spring.

**PRE-CONFIGURED THICKNESSES** - Varied thicknesses allow correct selection according to the amount of lean. Provides 1:1 ratio suspension lift on solid axle vehicles.

**SELF LOCATING DESIGN** - Raised profile locating flanges prevent packer from becoming dislodged or falling out.

## STRUT TRIM PACKERS

For use only with Ironman 4x4 struts, available individually to adjust "side to side" or "front to back" vehicle lean due to uneven load placement.



**PRECISE RIDE HEIGHT TUNING** - Basic steel collar design fits over Ironman 4x4 struts to adjust spring seat height.

**PRE-CONFIGURED THICKNESSES** - Varied thicknesses allow correct selection according to the amount of adjustment required. Usually provides 1:2 ratio suspension lift on independent suspension vehicles.

## EXTENDED BRAKE HOSES

Longer brake hose used with suspension lifts over 100mm (4").



**DOT SAE J1401 STANDARDS APPROVED CONSTRUCTION** - OEM style reinforced rubber hose for safety.

**EXTENDED LENGTH** - Extended length allows for greater suspension travel.

## ADJUSTABLE TRAILING ARMS

Used to correct rear axle tilt and location after raising suspension.



**COMPETITION SPEC** - 32mm solid rod used throughout.

**FINE THREAD ON-VEHICLE ADJUSTMENT** - M32 x 2mm thread ensures precision adjustment for greater accuracy.

**OEM STYLE RUBBER BUSHES** - Maximum flex and durability. Replaceable OEM compatible bushes.

## CASTER WEDGES

Adjusts the caster angle within solid axle vehicles, or changes pinion angle to remove unwanted driveline vibration.



**SUITS** - 60-70mm wide leaf springs. Breakaway side section can be removed for narrower springs.

**AVAILABLE IN** - 1, 2, 3 and 4 degree increments.

## SWAY BARS

Enhanced performance direct replacement sway bars featuring maximum bar diameter with factory compatible fitment.



**SHORE A 70 DURO NR** - Bushes maximum flex and durability.

## ADJUSTABLE STEERING RODS

Adjustable length rod to centralise steering wheel after suspension lift.



**ADJUSTABLE LENGTH** - Compatible with all suspension ride heights.

**STRONGER CONSTRUCTION** - Reduces likelihood of failure due to impact.

**BOLT ON STEERING DAMPER MOUNTS** - Steering damper mounts can be positioned freely as required to suit suspension lift.

## STRUT MOUNTS

Direct replacement for the OEM mounts. Facilitates the pre-assembly of complete new struts without disassembly of old unit.



**FULLY OEM COMPATIBLE** - Easy Installation.

**SHORE A 80 DURO NR BUSHES & INSULATORS** - Extended durability and precise location accuracy.

**HEAVY DUTY WASHERS** - Resists deformation in extreme use.

## ADD-A-LEAF

Additional universal tapered leaf to upgrade existing leaf springs.



Eliminates suspension sag and supports additional load.

Improves - Comfort and handling.

Increases load carrying capability and ride height.

## RUBBER BUSHES

Direct replacement for the OEM bushes, compatible with OEM and Ironman 4x4 suspension arms.



**OEM STYLE RUBBER BUSHES** - Easy press in replacement bushes, retains factory ride quality.

**SHORE A 70 DURO NR** - Maximum flex and durability.

## PRO-FORGE CONTROL ARMS

Provides corrected wheel alignment and greater operating clearance, allows for the installation of larger tyres and further increases ride height.



**HIGH STRENGTH FORGED ALLOY** - Stronger and more durable than a cast, machined or fabricated arm.

**BUSHES AND BALL JOINT** - Replaceable with OEM compatible or genuine components.

# Features and Benefits



## SUSPENSION KITS

*Fully integrated suspension kits containing all required components to achieve a safe and balanced suspension performance.*

**ALL LEAF SPRINGS KITS CONTAIN:** Springs, Shock Absorbers, U-bolts and Bushes.

**ALL COIL SPRINGS KITS CONTAIN:** Springs and Shock Absorbers.

Ironman 4x4 also offer various optional components further enhancing suspension performance or geometry correction purposes, see vehicle listings for model specific details.

Such components include Greasable Shackles & Pins, Steering Damper, Caster Correction, Trim Packers, Suspension Arms.



LEAF / LEAF (LL) SUSPENSION KIT



STRUT / LEAF (SL) SUSPENSION KIT



COIL / COIL (CC) SUSPENSION KIT



STRUT / COIL (SC) SUSPENSION KIT



TORSION BAR / LEAF (TL) SUSPENSION KIT



TORSION BAR / COIL (TC) SUSPENSION KIT

Please note: Not all coil springs are available in green and some may be supplied in yellow. Please check before ordering.



# Load Plus Helper Springs



**Without  
Load Plus**



**With  
Load Plus**

- ✓ **Maximise vehicle payload**
- ✓ **Improve safety and stability**
- ✓ **Reduce tyre, brake and suspension wear**

- ✓ **Reduce sway by up to 40%**
- ✓ **Reduce brake pitch by up to 20%**
- ✓ **Improve ride by up to 35%**
- ✓ **Reduce rear end sag by up to 20%**



# Load Plus Helper Springs - Application Guide

TO SUIT CHRYSLER / DODGE / PLYMOUTH		Part No
B1500, B2500, B3500 - Vans	All	LP7
Caravan, T & C Van & Voyager	All	LP7
	All	LP4
D50 & Ram 50	All	LP4
D100, D150, D200 & D250	All	LP4
Dakota	All	LP4
Durango	All	LP4
R1500 & R2500	w/ 2.5" Leaf	LP4
R1500 & R2500	w/ 3.0" Leaf	LP7
Raider	All	LP4
Ramcharger & Trailduster	All	LP4
W100, W150, W200 & W250	All	LP4
TO SUIT DAIHATSU		
Feroza F300, F310	88-99	LP1
Feroza II	All	LP4
Rocky	All	LP1
TO SUIT FIAT		
Fullback	All	LP3
TO SUIT FORD / LINCOLN / MERCURY		
Bronco	w/ 2.5" Leaf	LP4
	w/ 3.0" Leaf	LP7
Bronco II	w/ 2.5" Leaf	LP4
	w/ 3.0" Leaf	LP7
Courier / Ranger (Not USA model)	All	LP3
Econovan & Spectron	All	LP1
E Series Vans	w/ 2.5" Leaf	LP4
	w/ 3.0" Leaf	LP7
Excursion	All	LP7
Explorer	w/ Leaf	LP4
Falcon Sedan XR-XD	All	LP4
Falcon Panel Van XR-XH	All	LP4
Falcon Utility 1 Tonne XR - On	All	LP4
F Series	w/ 2.5" Leaf	LP4
	w/ 3.0" Leaf	LP7
Mountainer & Aviator	All	LP4
Ranger (USA model only)	All	LP4
* Not suitable for Falcon wagon, except dedicated LPG		
TO SUIT GENERAL MOTORS / CHEVROLET / HOLDEN		
Commodore 1 Tonne	All	LP1
Jackaroo	All	LP3
Rodeo / Colorado / D-Max*	81-03	LP3
Shuttle	All	LP3
Utility and Van HQ-WB	All	LP4
Astro & Safari Van	w/ Leaf	LP4
C, K, R & V Series 1/2 & 3/4 Ton	w/ 2.5" Leaf	LP4
	w/ 3.0" Leaf	LP7
Denali & Escalade	All	LP7
G Series, Express 1/2 3/4 & 1 Ton	w/ 2.5" Leaf	LP4
	w/ 3.0" Leaf	LP7
Savannah Vans 1/2 3/4 & 1 Ton	w/ 2.5" Leaf	LP4
	w/ 3.0" Leaf	LP7
LUV	All	LP3
S10 Blazer & T10	All	LP4
S15 Jimmy, T15 & Sonoma	All	LP4
Suburban 1/2 3/4 Ton	w/ 2.5" Leaf	LP4
	w/ 3.0" Leaf	LP7
Tahoe & Yukon	w/ 2.5" Leaf	LP4
	w/ 3.0" Leaf	LP7
Silverado	All	LP7
*Not suitable for Rodeo / Colorado / D-Max 2003+ Models with interleaf liners		
TO SUIT HONDA		
Passport	w/ Leaf	LP3
TO SUIT INTERNATIONAL		
Scout	All	LP3

TO SUIT ISUZU		
Amigo	All	LP3
Hombre	All	LP3
Pickup, P'up	All	LP3
Rodeo	w/ Leaf	LP3
Trooper II	w/ Leaf	LP3
TO SUIT JEEP		
Cherokee & Wagoneer	All	LP4
CJ5, CJ6 & CJ7	All	LP4
Comanche Pickup	All	LP4
Gladiator Pickup	All	LP4
J10 & J20 Series	All	LP4
Wrangler YJ	All	LP4
TO SUIT KIA		
Pregio	All	LP4
TO SUIT LDV		
T60	All	LP2
TO SUIT MAZDA		
Navaho	All	LP4
Pickups	All	LP3
Bravo / BT50	All	LP3
B1800 / B2000 4x2	All	LP3
B2200 / B2600 4x2 4x4	All	LP1
E1400	All	LP1
E1800	All	LP1
E2000	All	LP1
E2200	All	LP1
TO SUIT MERCEDES BENZ		
MB100	99-02	LP4
MB140	99-02	LP4
Sprinter	98 On	LP4
TO SUIT MITSUBISHI		
Pickup	All	LP4
Pajero / Montero	w/ Leaf	LP4
Triton ME-MN L200	All	LP4
Triton MQ L200	All	LP3
L200 / L300 Van	All	LP4
Starwagon / Express Van	All	LP4
TO SUIT NISSAN		
Frontier	All	LP2
X-Terra	All	LP2
Titan	All	LP2
Navara D21 D22	All	LP3
Navara D40	All	LP2
Navara NP300 (leaf)	All	LP2
Urvan	All	LP3
Patrol GQ / GU Cab / Chassis	All	LP4
Patrol MQ / MK, G160, Y260	All	LP3
TO SUIT SUZUKI		
Sierra / Samurai	All	LP5
TO SUIT TOYOTA		
To Suit Pickups	All	LP2
To Suit T100	All	LP4
To Suit Tundra	All	LP3
To Suit Hiace	All	LP3
To Suit Hilux / 4Runner	All	LP2
To Suit Landcruiser FJ40 / BJ40-42	60-84	LP4
To Suit Landcruiser FJ / HJ60 / 61 / 62	80-90	LP4
To Suit Landcruiser HJ / HZJ 75*	84-99	LP4
To Suit Landcruiser HZJ 78 / 79*	All	LP9
To Suit Landcruiser 76*	All	LP4
To Suit Tacoma	All	LP2
To Suit Townace	All	LP1
* Suits Landcruiser drum brake rear models only		
TO SUIT VOLKSWAGEN		
Amarok	All	LP4



# DRIVE LIKE A PRO

Suspension kits built for  
*Comfort - Performance - Constant Load*



**FOAMCELL<sup>PRO</sup>**  
Suspension Kit

The ultimate upgrade with the most  
robust design suitable for all conditions

Colours and styles may vary between models. Prices do not include freight or fitting and are subject to change without notice.

[www.ironman4x4.com](http://www.ironman4x4.com)





# *Suspension Specifications*

*Effective 1 November 2021*



# Recommended Installation Times

Average installation times are based on one experienced fitter with all the necessary tools and equipment

## SUSPENSION KITS

<b>COIL SPRINGS</b> Front	<b>LEAF SPRINGS</b> Rear	<b>3 Hours</b>
<b>STRUT</b> Front	<b>COIL SPRINGS</b> Rear	<b>3 Hours</b>
<b>STRUT</b> Front	<b>LEAF SPRINGS</b> Rear	<b>4 Hours</b>
<b>TORSION BAR</b> Front	<b>COIL SPRINGS</b> Rear	<b>3 Hours</b>
<b>TORSION BAR</b> Front	<b>LEAF SPRINGS</b> Rear	<b>4 Hours</b>
<b>COIL SPRINGS</b> Front and Rear		<b>2 Hours</b>

<b>LEAF SPRINGS</b> Front and Rear	<b>5 Hours</b>
<b>STRUT</b> Front and Rear	<b>4 Hours</b>
<b>LAND ROVER MODELS</b>	<b>3 Hours</b>
<b>VOLKSWAGEN AMAROK</b>	<b>5 Hours</b>
<b>MITSUBISHI PAJERO</b> 2000 +	<b>4 Hours</b>
<b>MITSUBISHI TRITON</b> 2005 +	<b>5 Hours</b>

## SUSPENSION COMPONENTS

<b>COIL SPRINGS</b> Pair	<b>1 Hour</b>
<b>COIL SPRINGS</b> Pair Independent Suspension	<b>2 Hours</b>
<b>COIL SPRINGS</b> Pair with Existing Airbags	<b>2 Hours</b>
<b>LEAF SPRINGS</b> Pair	<b>2 Hours</b>
<b>LEAF SPRINGS</b> Pair with Existing Airbags	<b>2.5 Hours</b>

<b>TORSION BARS</b> Pair	<b>2 Hours</b>
<b>STRUT SHOCK ABSORBERS</b> Pair	<b>2 Hours</b>
<b>SHOCK ABSORBERS</b> Pair	<b>1 Hour</b>
<b>STEERING DAMPER</b>	<b>0.5 Hour</b>
<b>CASTER CORRECTION BUSHES</b>	<b>2 Hours</b>

All times to be used as a guide only, times may vary depending on experience and equipment. Pre existing modifications or accessories may also increase installation times. Always allow extra time for unforeseen issues or rusted components. Always use Ironman 4x4 Suspension Installation Form to record ride height before and after, vehicle and owner details.

## WHEEL ALIGNMENT

<b>SOLID AXLE</b> Wheel Alignment	<b>0.5 Hour</b>
--------------------------------------	-----------------

<b>INDEPENDENT SUSPENSION</b> Wheel Alignment	<b>1 Hour</b>
--	---------------

Ironman 4x4 recommend a wheel alignment be performed after installation or within 1 week, always ensure suspension is fully settled before wheel alignment.

As a minimum, toe settings will require adjustment after raising suspension. Camber and Caster settings are an important aspect and should be maintained close to manufacturers specifications.

Consideration to road crown should be given.

It is advisable to induce slightly more (positive caster) and (negative camber) on the kerb side wheel to help maintain directional stability.

As a general rule of thumb it is recommended to adjust as follows: (Unless tyre wear dictates otherwise).

**Independent Front Suspension** vehicles will generally result in increased toe-in when raised.

*Total Toe:* +1mm to -1mm.

**Solid Front Axle** vehicles generally only allow toe adjustment.

*Total Toe* +1mm to -1mm

**4 Wheel Independent Suspension** vehicles will require a 4 wheel alignment to ensure front and rear wheels are true to the geometric centreline of the vehicle.

*Rear Total Toe:* +1mm to +3.5mm (Do not set with Toe Out)

*Front Total Toe:* +1 to -1mm

Optimal wheel alignment settings can vary between vehicles, the above is to be used as a guide only, different ride heights may require different settings. Always monitor tyre wear and pressures and adjust accordingly.



# Installation Form



## SUSPENSION INSTALLATION FORM IRONMAN 4X4

Please copy and complete this form at the time of installation.  
Keep in a safe place for future reference.

Always ensure you have all the correct parts before beginning installation.

Installing suspension often requires special tools and expert knowledge. All fitment should be performed by a qualified and experienced fitter. Always tighten bushed components after the vehicle is let down onto the ground at normal ride height, otherwise damage from torsional stresses can occur.

Ironman 4x4 recommends a wheel alignment after fitment of new suspension, consideration to natural spring settling should be taken into account before alignment is done. Always adhere to vehicle manufacturers torque specification when tightening fasteners.

Always grease polyurethane bushes prior to fitment, Ironman 4x4 recommends a molybdenum based grease or grease specified for polyurethane.

**If necessary, brake proportioning valve should only be adjusted and tested by a qualified brake specialist.  
Further ADAS or TSS safety systems may need to be recalibrated by a qualified service technician.**

### OWNER DETAILS

NAME: ..... PHONE: .....  
ADDRESS: .....

### VEHICLE DETAILS

MAKE: ..... MODEL: ..... VIN / REG NO: .....  
ODOMETER: ..... ENGINE TYPE: ..... BODY TYPE: .....  
PRE EXISTING MODIFICATIONS OR WEIGHTED ACCESSORIES: .....

### PART NUMBERS INSTALLED

PART # .....	BATCH# .....	PART # .....	BATCH# .....
PART # .....	BATCH# .....	PART # .....	BATCH# .....
PART # .....	BATCH# .....	PART # .....	BATCH# .....
PART # .....	BATCH# .....	PART # .....	BATCH# .....
PART # .....	BATCH# .....	PART # .....	BATCH# .....

### SUSPENSION MEASUREMENTS

VEHICLE HEIGHT  
LOWER OF WHEEL RIM TO GUARD

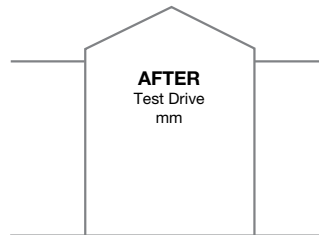
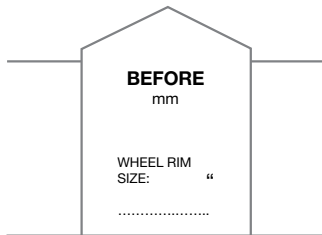

### SUSPENSION MEASUREMENTS

ACTUAL MEASUREMENT OF NEW SPRINGS  
PRIOR TO INSTALLATION

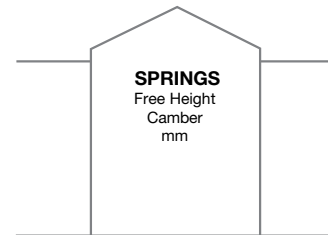

### NOTES AND COMMENTS

NOTES: .....

### POST INSTALLATION INSPECTION

All fitting, fasteners and wheels have been tensioned to the correct manufacturers specifications and marked with a paint pen where appropriate.

INSTALLERS NAME: ..... PRINT NAME .....  
SIGNATURE: .....  
DATE OF INSPECTION: .....

All measurements to be taken prior to installation, immediately after initial test drive and again at 500km check.  
All vehicle height measurements to be taken from lower of wheel rim to guard unless otherwise stated. Up to 10mm height reduction in springs can be considered normal settling over time. All measurements are metric except wheel rim size.  
Suspension product warranty period is 3 years or 60,000km, GVM warranty period is 2 years or 40,000km unless otherwise stated.

SIF/24/0920 Rev.2



# Coil Springs

## COIL SPRING MEASUREMENT REFERENCE

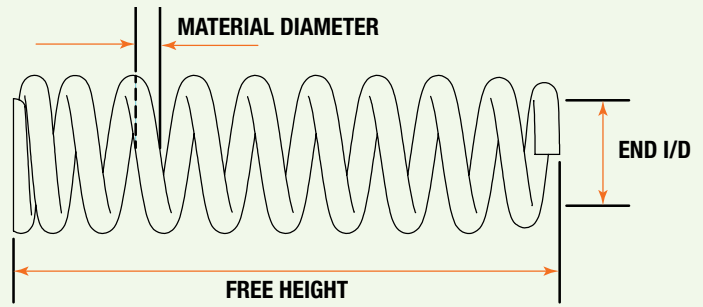

Part Number	Material	Free Height	End I/D	Spring Rate N/mm	Spring Rate lb/in
FOR001A	17	372	81	115	656
FOR001B	17.5	375	81	124	708
FOR001C	18	373	81	136	776
FOR001S	17.5	355	81	124	708
FOR003B	18	505	90/135	40-56	228-320
FOR003C	18	515/520	90/135	56	320
FOR003S	18	475	90/135	40-56	228-320
FOR005A	17.5	381	81	118	673
FOR005B	18	381	81	126	719
FOR005C	18	387	81	132	753
FOR005S	18	365	81	126	719
HOLD008B	16.4	425	104	43	246
HOLD008C	17	420	106	48	274
HOLD020A	16.5	382	66/76	100	571
HOLD020B	17	375	66/76	110	628
HOLD020C	18	370	66/76	127	725
HOLD020S	17	362	66/76	100	571
HOLD022A	15	400	66	40	228
HOLD022B	16	410	65	47	269
HOLD022C	17	415	65	58	331
HOLD022S	15	380/375	65	40	228
HOND001B	13	360/355	61/70	52	297
HOND002B	13.5	420	72/79	40	229
HYUND003B	17	407	148	33	189
IMAZ001B	16	395	102	49	280
JEEP003B	15	432/436	65/100	37	211
JEEP006B	14	380/375	62/102	32	183
JEEP007B	15	440/435	66/100	36	206
JEEP008B	16	345/335	72	35	200
JEEP012B	15	420/410	98	39	223
JEEP012C	15	440/430	98	38	217
JEEP013B	16	370/360	75	43	246
JEEP014B	16.5	375	82	78	446
JEEP014C	16.5	382	82	78	446
JEEP015B	17	323	85/115	38	217
JEEP016B	15.5	468	70/102	38	217
JEEP017B	15	460/450	73.5/103	32	183

Part Number	Material	Free Height	End I/D	Spring Rate N/mm	Spring Rate lb/in
JEEP017C	15.5	460/450	73.5/103	36	206
JEEP018A	15.5	388	52/103	40	229
JEEP018B	16	388	52/103	45	257
JEEP019B	15	500	73/103	32	183
JEEP020B	16	417	56/103	43	246
JEEP021EA	17	420	58.5/95	61	349
JEEP025B	15.5	448	65/88	57	326
JEEP025C	15.5	463	65/88	57	326
JEEP026B	20	368	55/90	114	650
JEEP026C	21	365	55/90	154	879
JEEP029A	14	443	74/102	27	154
JEEP029B	14	455/450	74/102	27	154
JEEP029C	14	475/480	74/102	27	154
JEEP030A	15	388/393	71/78	28	160
JEEP030C	16	415/420	71/78	36	206
JEEP031B	15	505	74/102	27	154
JEEP032B	16	520	65/130	29	166
JEEP032C	17	525	65/130	36	206
JEEP032D	19	520	65/130	44	251
JEEP030B	16	395/400	71/78	31	177
KIA007B	16	387	79/129	35	201
LADA001B	16	285	92	89	509
LADA002B	14	435	100	32	183
LAND005B	17	400	118	41.1	535
LAND006B	20	405	134	81	462
LAND006C	21	440	134	81.9	468
LAND007B	16	390/382	118	41	234
LAND008B	17	440	134	36.6	209
LAND009B	16	405/395	117	36	206
LAND011B	17	425/420	117	46-53	262-302
LAND011C	18	425/420	118	56-64	319-365
LAND014B	15	410/390	117	30	171
LAND019B	17	415	90	83	474
LAND019C	17	427	90	83	474
LAND020B	21	402	80/100	82	469
LAND020C	21	415	80/100	88	503
MAH003B	15	405	97	46	263

# Coil Springs

Part Number	Material	Free Height	End I/D	Spring Rate N/mm	Spring Rate lb/in
MERC015B	14.5	495/485	110	28	160
MERC016B	18	445/433	140	28-44	159-251
MERC020B	15	498	111	30.2	172
MERC021B	12, 15, 16 & 18	470	140	20-40	114-228
MITS020B	17	405/400	145	34	194
MITS020C	18	420	148	39	223
MITS022B	16	410/400	145	27	154
MITS025B	17	390	124	45	257
MITS034B	16	367	140	35	200
MITS035B	14	315/305	120	40	229
MITS038B	19	323	72/93	141	806
MITS038C	19	336	72/93	141	806
MITS039A	21	330/320	113	136	777
MITS039B	21	350/340	113	136-166	777-948
MITS039C	22	335	113.5	162-196	925-1119
MITS040A	17	325	64/93	105	600
MITS040B	18	325	64/92	110	628
MITS040C	18	330	64/92	110	628
MITS040S	18	310	64/93	118	674
MITS042A	17	380	145	32	183
MITS042B	17	403	145	32	183
MITS042C	18	360	146	50	286
MITS042S	17	360	145	32	183
MITS045B	18	335	92/67	110	628
NISS007B	16	415/400	89/122	36.9	211
NISS008B	17	490/480	139	33	189
NISS009B	17	410/387	87/122	46	263
NISS009C	18	415/398	89/122	58	331
NISS010B	19	468/448	139	50	286
NISS010C	19	488/470	139	46	263
NISS018B	14	427	106	34	194
NISS020B	19	490/480	139	50	286
NISS020C	20	475/458	139	60	343
NISS020D	22	475/453	139	85	486
NISS024B	17	425/410	87/122	46	263
NISS026B	18	484/469	87/122	48	274
NISS027B	20	535/521	139	52	297
NISS027C	21	552/540	139	70	400
NISS034B	16	400	119/146.5	28	160
NISS035B	15	370	126	29	166
NISS038B	15	325	134/146	36	206
NISS039B	15	325	114/146	36	206
NISS040A	16	375	81	89	508
NISS040B	17	370	81	97	554
NISS040C	17	380	81	97	554
NISS040D	17.5	380	81	96.7	552
NISS042B	19	443	119	75	429
NISS042C	20	443	119	90	514

Part Number	Material	Free Height	End I/D	Spring Rate N/mm	Spring Rate lb/in
NISS043B	19	525/510	87/122	48	274
NISS044B	21	590/575	139	49	280
NISS044C	22/18	585/570	139/132	74	422
NISS045A	20	373	101	135	771
NISS045B	20	385	101	135	771
NISS045C	20	390	101	135	771
NISS045EA	21	385	101	154	878
NISS045EA2	21	380	100	176	105
NISS046A	21	515	119	90	514
NISS046B	21	522	119	90	514
NISS046C	21.5	528	119	99	566
NISS046EA	22	525	121	97	556
NISS046EA1	23	533	121	119	679
NISS046EA2	23	528	119	140	800
NISS058A	16	445	84/121.5	35-45	200-256
NISS058B	16	445	84/121.5	35-60	200-342
NISS058C	18	445	84/121	57	325
NISS058D	18.5	445	85/122	74	423
RAM015A	19	405	70/85	103	588
RAM015B	19	410	70/85	105	599
RAM015C	19	410	70/85	113	645
RAM016A	16	485	65/111.6	37	211
RAM016B	17	495	65/112	44	251
RAM016C	19	505	65/112	63	359
REN001B	13.5	410	99.5/117.5	30	171
REN002B	14	395	99/117	35	200
SSANG002B	16	410	116	41	234
SSANG003B	17	312	60/99	91	519
SSANG003C	17	319	60/99	93	531
SSANG004B	15	375	114.1	42	239
SSANG004C	16	375	114	50	285
SSANG006B	15	395	114.1	42	239
SSANG006C	16	395	114	50	285
SSANG010B	17	298	65/88	123	702
SUB001B	15	350	121/143	31	177
SUB002B	15.5	345/340	128	38.28	219
SUB003B	15.5	355	123/144	30	171
SUB004B	15	365	99/135	39	223
SUB005B	16	298	124/144	53	301
SUB006B	13.5	343	84	50	284
SUB014B	13	390	83.6/77.6	35	199
SUZ003B	16	280	70/80	102	582
SUZ004B	12	345	70/82	25.4	145
SUZ005B	16	290	80.5/70.5	103	589
SUZ006B	13	340	72/82	33	189
SUZ008B	11	325/320	70/82	27	154
SUZ009B	12	372	75/82.5	27	154
SUZ009C	12	387	75.5/82	27	154



# Coil Springs

Part Number	Material	Free Height	End I/D	Spring Rate N/mm	Spring Rate lb/in
SUZ010B	12	340/320	75/84	30.9	176
SUZ010C	12.5	363/343	75/84	36	205
SUZ011B	12	335	75/84	30.9	176
SUZ011C	12.5	350	75/84	36	205
SUZ013B	12.5	345	62/80	33	189
SUZ015B	16	320	72/82	86	491
SUZ016B	12.5	360	62/80	33	189
SUZ017B	16	340	72/82	86	491
SUZ018B	14	360	63/96	35	200
SUZ019B	16	381	125	42	240
SUZ019C	16	395	125	42	240
SUZ020A	16.5	363	72	72	440
SUZ020B	17	368	72	88	503
SUZ020C	17	378	72	88	503
TOY012C	19	515/520	84/119	49	280
TOY013B	18	485/495	108/140	40	229
TOY013C	20	490/497	108/140	57	326
TOY013D	21	490/495	108/140	72	411
TOY017A	16	470	90	54-60	308-342
TOY017B	16	463	90	59	337
TOY017EA	18	450	90	88.9	507-619
TOY017S	16	455	90	54-60	308-342
TOY018B	14	395/380	86/100	35	200
TOY019B	16	420/405	86/125	38.2	218
TOY023B	16	395/390	103/133	31	177
TOY023C	17	375/370	103/134	38.2	218
TOY024B	17	480/485	81/116	41	234
TOY024C	17	500/505	82/117	41	234
TOY025B	18	473/483	108/139	40	229
TOY025C	19	460/475	107/139	48	274
TOY025D	22	470/478	108/140	70	400
TOY038B	16	348/357	67/76	108	617
TOY038C	17	357	67/76	133	760
TOY039A	15	398	74/114	31-36	177-205
TOY039B	15	410	74/114	31-36	177-206
TOY039C	17	385	74/114	45-51	256-291
TOY046A	16	470	86/100	50	286
TOY046B	17	463	86/100	57	325
TOY046C	17.5	465	85.5/100	60	342
TOY046D	18	455	85/100	71	405
TOY046EA	19	500	100/85	76	434
TOY046EA1	20	490	99/84	93	532
TOY048B	14	438	100	34	194
TOY048C	14.5	428	100	39	223
TOY049B	17	450	87/125	34	194
TOY049C	18	440	87/125	44	251
TOY055A	16.5	380	66/76	106	606

Part Number	Material	Free Height	End I/D	Spring Rate N/mm	Spring Rate lb/in
TOY055B	17	380	66/76	117	669
TOY055C	18	373	66/76	143	817
TOY055EA	19	365	66/76	171	975
TOY055EA1	19	365	66/76	171	975
TOY056A	16.5	400	83.5/130.5	41	234
TOY056B	17	395	83/130	49	280
TOY056C	18	392	85/129	62	354
TOY060B	20	614/622	84/119	44	251
TOY061B	21	627/637	108/140	43	246
TOY061C	22	565/572	108/140	68	388
TOY063A	19	455/445	74/89	102	583
TOY063B	19	475/465	74/89	102	583
TOY063C	19	485/475	74/89	102	583
TOY063EA	20	445/435	89/73	117	668
TOY063EA1	21	435	74/89	136	775
TOY063EA2	22	430	87/73	186	1064
TOY063S	19	425/415	74/89	113	645
TOY064A	19	440/425	108/144	47	269
TOY064B	19	470/455	108/144	47	269
TOY064C	21	465/475	108/144	65	371
TOY064D	22	465	107/144	80	456
TOY064EA	20	475/465	108/144	50	286
TOY064EA1	24	427	105/144	113	645
TOY064EA2	25	435	108/140	126	718
TOY064S	18	457/442	108/144	42	240
TOY065A	18	390	66/76	126	720
TOY065B	18	382	66/76	145	827
TOY065C	18	380	66/76	145	827
TOY067B	18	300	82/122	90	514
TOY069B	17	420	83/130	48	274
TOY070B	19.5	430	66/89	132	754
TOY070C	19.5	437	66/89	132	754
TOY070EA	22	390	63/88	189	1079
TOY072B	18	365	135/107	59	336
TOY072EA	19	380	107/135	69	393
TOY076C	18	388	140	58	331
TOY079B	17.5	525	101/86	54	308
TOY080A	15	415	114	30	171
TOY082A	15	442	94	96	548
TROL001B	15.5	390	94	58	331
TROL002B	15.5	430	102	39	223
TROL003B	15.5	395	95	52	297
TROL004B	15	435	99	38	216
VOLKS001B	17.5	330	65.5/90	119	679
VOLKS001C	18	330	65.5/90	137	783
VOLKS001D	18	335	65.5/90	137	783

# Leaf Springs

## LEAF SPRING MEASUREMENT REFERENCE

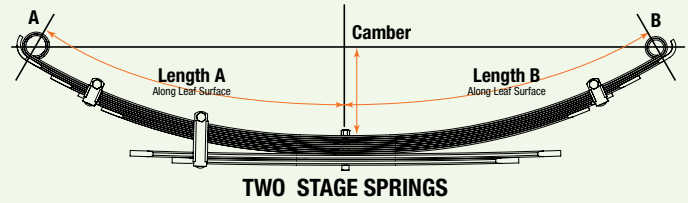
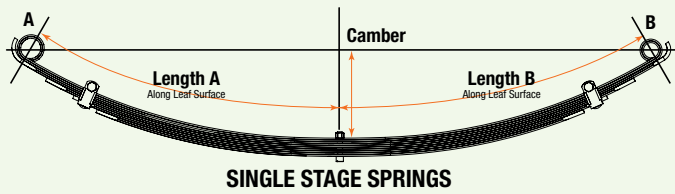

Part Number	Length A	Length B	Camber	Leaves	Width	Eye A	Eye B
FOR002A	585	735	120	5+2	60	55	32
FOR002B	585	735	130	5+2	60	55	32
FOR002C	585	735	145	6+2	60	55	32
HOLD004A	555	650	240/230	5+1	60	40	30
HOLD004B	555	650	250/240	5+1	60	40	30
HOLD004C	555	650	250/240	6+1	60	40	30
HOLD006A	608	602	205	4+1	60	40	30
HOLD006B	608	602	205	5+1	60	40	30
HOLD006C	608	602	205	6+2	60	40	30
HOLD006D	608	602	205	6+2	60	40	30
HOLD021A	607	763	145	5+2	60	40	30
HOLD021B	607	763	155	5+2	60	40	30
HOLD021C	607	763	160	6+2	60	40	30
HOLD021D	607	758	160	6+2	60	40	30
HOLD023B	650	650	175	5+2	60	40	30
HOLD023C	650	650	175	6+2	60	40	30
IMAZ002B	650	700	165	8	60	42	32
ISL6010	270	270	48	1	60		
JEEP004B	585	725	195/175	5+2	63	64.5	44.3
JMC002B	610	690	150	5+2	60	40	30
JMC002C	610	690	130	5+2	60	40	30
MAH002B	612	610	185	5+2	70	35	35
MAZDA006A	530	670	165	5+1	60	32	32
MAZDA006B	530	670	150	6+2	60	32	32
MAZDA006C	530	670	165	6+2	60	32	32
MAZDA006D	530	670	150	7+2	60	32	32
MAZDA041A	590	730	140	4+2	60	40	32
MAZDA041B	590	730	140	4+2	60	40	32
MAZDA041C	590	720	140	5+2	60	40	32
MAZDA041D	590	720	130	6+2	60	40	32
MTS018A	520	685	200	4+1	70	32	28
MTS018B	515	685	195	4+1	70	32	28
MTS018C	515	685	190	5+1	70	32	28
MTS041A	515	685	140	4+1	70	32	28

Part Number	Length A	Length B	Camber	Leaves	Width	Eye A	Eye B
MTS041B	515	685	145	4+1	70	32	28
MTS041C	515	685	155	5+1	70	32	28
MTS047A	550	775	140	5+1	60	40	28
MTS047B	550	775	140	5+1	60	40	28
MTS047C	550	775	140	5+2	60	40	28
NISS003B	560	550	185/170	6	60	22	33
NISS004B	605	835	250/235	8	60	33	33
NISS005B	560	550	185/170	6	60	40	33
NISS011C	550	550	180/170	7	70	40	35
NISS012C	595	825	217/200	7+2	70	35	35
NISS012D	600	830	240/225	7+3	70	35	35
NISS014A	565	635	145/135	4+2	60	40	33
NISS014B	565	635	130/120	4+1	60	40	33
NISS014C	565	635	130/120	5+1	60	40	33
NISS021B	650	580	200	8	60	33	40
NISS041B	670	735	195	5+1	60	40	33
NISS041C	670	730	190	6+1	60	40	33
NISS041D	670	730	180	7+2	60	40	33
NISS047B	635	715	195	7+1	60	40	33
NISS049B	700	650	230	5+1	60	40	33
NISS057B	670	605	175	5+2	60	40	33
NISS057C	670	605	175	6+2	60	40	33
SSANG005B	710	720	200	5+1	70	56	28
SSANG005C	710	720	200	6+1	70	56	28
SUZ001B	480	470	120/110	5	50	30	40
SUZ002B	510	520	175/155	4+1	50	40	30
TOY001B	510	610	160	7	70	25	25
TOY002B	510	620	180	7	70	25	25
TOY003C	660	660	230	7+3	70	30	30
TOY004B	510	610	160	7	70	35	35
TOY004C	502	603	155	8	70	35	35
TOY005C	655	675	230	7+3	70	35	35
TOY006B	555	555	150	7	70	35	35
TOY006C	555	555	175	8	70	35	35

# Leaf Springs

Part Number	Length A	Length B	Camber	Leaves	Width	Eye A	Eye B
TOY006D	550	550	175	9	70	35	35
TOY007A	570	655	230/220	7	70	35	35
TOY007B	570	645	220/205	6+1	70	35	35
TOY007C	565	655	230/220	7+1	70	35	35
TOY008B	555	590	180	7	70	35	35
TOY008C	555	590	180	8	70	35	35
TOY009B	610	730	210	6+2	70	40	40
TOY009C	610	720	210	7+2	70	40	40
TOY009D	605	720	215	8+2	70	40	40
TOY009E	610	720	220	9+2	70	40	40
TOY010B	575	575	135/115	5	60	30	30
TOY010C	575	575	130/110	6	60	30	30
TOY011B	530	670	200	4+2	60	30	30
TOY011C	530	670	210	5+2	60	30	30
TOY027A	560	740	200	6+2	60	40	30
TOY027B	560	740	200	4+2	60	40	30
TOY027C	560	740	200	5+2	60	40	30
TOY034B	505	630	205	7	70	35	35
TOY044C	535	670	150	4+2	60	40	40
TOY047A	695	815	245	7+2	70	40	40
TOY047B	698	815	235	8+2	70	40	40
TOY047C	698	815	235	9+2	70	40	40
TOY047D	698	815	235	9+2	70	40	40

Part Number	Length A	Length B	Camber	Leaves	Width	Eye A	Eye B
TOY047E	698	815	250	9+2	70	40	40
TOY057A	610	690	170	6+2	60	40	30
TOY057B	610	690	190	4+2	60	40	30
TOY057C	610	690	190	5+2	60	40	30
TOY057D	610	690	200	6+2	60	40	30
TOY062B	620	785	245	7+2	70	40	40
TOY062C	620	785	245	8+2	70	40	40
TOY062D	625	785	250	10+2	70	40	40
TOY066B	705	705	185/175	5+2	60	40	40
TOY066C	705	705	185/180	6+2	60	40	40
TOY068B	590	685	200	4+2	60	40	30
TOY068C	590	685	190	6+2	60	40	30
TOY071B	800	815	200	4+2	60	40	40
TOY071C	800	815	200	5+2	60	40	40
TOY073B	655	755	130	3	70	70	60
TOY073C	655	755	130	4	70	70	60
TOY077A	700	700	170	5+2	60	40	30
TOY077B	700	700	170	5+2	60	40	30
TOY077C	700	700	170	6+2	60	40	30
TOY077D	700	700	170	6+2	60	40	30
VOLKS002B	750	760	245	5+2	70	60	46
VOLKS002C	750	760	255	6+2	70	60	46

**LEAF SPRING SPARE PARTS**

099	3/8" x 4" Centre Bolt
098	5/16" x 4" Centre Bolt
635	3/8" x 4" Centre Bolt - Extended Head
CLINER001	Plastic Clip Liner
AFPAD001	Plastic Anti-Friction Pad (Oval Locator)
AFPAD002	Plastic Anti-Friction Pad (Round Locator)
IWEDGE04	1 Degree Wedge Kit
IWEDGE08	2 Degree Wedge Kit
IWEDGE10	3 Degree Wedge Kit
IWEDGE12	4 Degree Wedge Kit

# Torsion and Sway Bars

## TORSION AND SWAY BAR MEASUREMENT REFERENCE

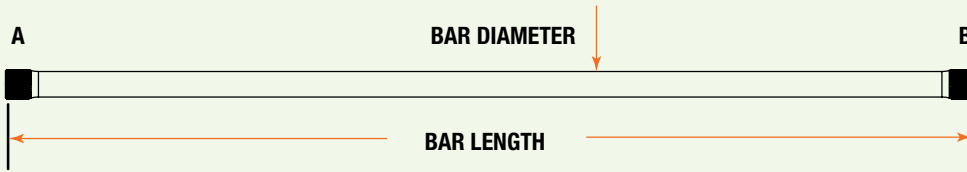

Part Number	Length	Diameter	A End Spline Count	B End Spline Count
HOLD005A	1000	26	43	43
HOLD007	1000	26	47	47
HOLD009	1220	30	47	47
HOLD010	1144	30	47	47
HYUND004	1275	29	43	43
MAZDA005	924	26	40	40
MAZDA014	1025	27	40	40
MAH001	1063	28	43	43
MITSO13	1278	26	39	40
MITSO15C	1370	28	39	40
MITSO19	1308	28	39	40
MITSO31	1165	24	40	40

Part Number	Length	Diameter	A End Spline Count	B End Spline Count
NISS013	1203	26	39	39
NISS017	1232	26	39	39
NISS025	894	26	39	39
NISS048	866	26	39	39
SSANG001	1040	26	40	40
TOY026	1063	26	43	40
TOY042	1212	27	40	40
TOY050	1160	32	46	46
TOY051	1210	32	46	46

SWAY BAR SPARE PARTS	SWAY BAR	REPLACEMENT BUSH	
To Suit Toyota Landcruiser 200 Front	<b>ISB200F</b>	<b>ISBB20038R</b>	Rubber Sway Bar Chassis Bush 38mm
To Suit Toyota Landcruiser 200 Rear	<b>ISB200R</b>	<b>ISBB20033R</b>	Rubber Sway Bar Axle Mounting Bush 33mm
		<b>ISBB200REB</b>	Rubber Sway Bar End Bush
To Suit Nissan Patrol Y62 Front	<b>ISB600F</b>	<b>ISBB60036R</b>	Rubber Sway Bar Chassis Bush 36mm
To Suit Nissan Patrol Y62 Rear	<b>ISB600R</b>	<b>ISBB60027R</b>	Rubber Sway Bar Axle Mounting Bush 27mm
To Suit Toyota Landcruiser 70 Front Diesel	<b>ISB789FW</b>	<b>ISBB78933R</b>	Rubber Sway Bar Chassis Bush 33mm
		<b>ISBB789REB</b>	Rubber Sway Bar End Bush
		<b>ISBB789DB</b>	Chassis Mounting D Bracket
To Suit Toyota Landcruiser 70 Front Petrol	<b>ISB789FWP</b>	<b>ISBB78933R</b>	Rubber Sway Bar Chassis Bush 33mm
		<b>ISBB789REB</b>	Rubber Sway Bar End Bush
		<b>ISBB789DB</b>	Chassis Mounting D Bracket
To Suit Toyota Landcruiser 70 Rear	<b>ISB789RW</b>	<b>ISBB78930R</b>	Rubber Sway Bar Axle Mounting Bush 30mm
		<b>ISBB789REB</b>	Rubber Sway Bar End Bush
		<b>ISBB789DB</b>	Axle Mounting D Bracket
		<b>ISBB789RBK</b>	Chassis Mounting Bracket Set
To Suit Toyota Hilux 2015+ Front	<b>ISB80F</b>	<b>ISBB8033R</b>	Rubber Sway Bar Chassis Bush 33mm

# Shock Absorbers



## SHOCK ABSORBER MEASUREMENT REFERENCE

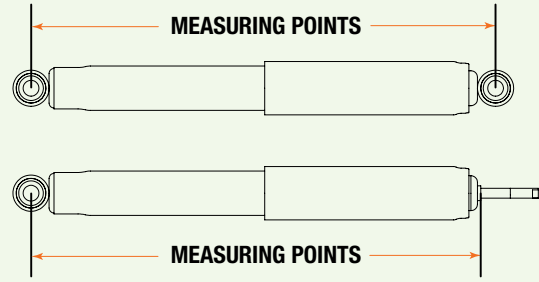

Part Number	Extended (mm)	Compressed (mm)	Upper Mount Type	Upper Replacement	Lower Mount Type	Lower Replacement	Part Number	Extended (mm)	Compressed (mm)	Upper Mount Type	Upper Replacement	Lower Mount Type	Lower Replacement
12075GR	487	296	ST1	2244K	ST1	2244K	12658GR	510	320	ST1	2244K	ET83	-
12076GR	583	347	B1	632RF	ST1	2244K	12661GR	535	329	ST1	2244K	B2	635RK
12080GR	552	332	ST38	656RK	ST38	656RK	12665GR	565	345	ST1	2244AK	CB7	CB7
12081GR	631	388	B2	635RK	B2	635RK	12666GR	560	348	CB20	CB20	B5	-
12082GR	342	232	ST1	2244K	CB7	CB7	12667GR	381	250	ST1	2244K	ET17	ET17
12083GR	505	310	STEM 57 X M14	-	CLEVIS	-	12669GR	560	348	CB20	CB20	ET24	-
12085GR	485	298	ST1	2244K	B1	632RF	12670GR	562	351	B5	-	ET24	-
12086GR	500	313	B1	632RF	B1	632RF	12671GR	627	372	ST1	2244K	B1	632RF
12087GR	350	236	ST1	2244K	ET17	ET17	12682GR	618	373	ST38	656RK	B2	635RK
12088GR	368	245	ST1	2244K	ET113	ET113	12682GRC	618	373	ST38-1	ST38-1	ET38	ET38
12089GR	510	320	ST1	2244K	ET83	-	12682GRP	618	373	ST38-1	ST38-1	ET38	ET38
12091GR	510	310	ST38	656RK	ST38	656RK	12683GR	615	365	ST38	656RK	ST38	656RK
12094GR	655	402	B2	635RK	B2	635RK	12691GR	462	343	ST38	656RK	ET153	ET153
12095GR	631	382	ET104	ET104	ET69	ET69	12696GR	570	347	ET161	-	ST38	656RK
12635GR	485	307	B1	632RF	B1	632RF	12697GR	520	322	B2	635RK	ST38	656RK
12636GR	588	357	B1	632RF	B1	632RF	12698GR	624	381	B1	632RF	B1	632RF
12636GRP	588	362	B1	632RF	B1	632RF	12710GR	564	432	STEM 95 X M12	ST710RK	ET153-1	ET153-1
12637GR	577	348	ST1	2244K	B2	635RK	12711GR	318	206	STEM 68 X M10	-	-	-
12639GR	484	298	ST1	2244K	ET17	ET17	12712GR	570	357	ET19	-	ET141	-
12640GR	564	343	B2	635RK	ST38	656RK	12712LGR	700	416	ET19	-	ET141	-
12643GR	412	261	ST6	2244AK	ET17	ET17	12713GR	470	325	STEM 86 X M10	-	ET158	ET158
12644GR	510	320	ET153	-	ET36	-	12714GR	575	351	ST1	ST714RK	ET159	-
12645GR	531	333	B1	632RF	ET142	-	12715GR	423	305	STEM 71 X M10	-	ET158-1	ET158-1
12645GRS	520	328	B1	632RF	ET142	-	12716GR	389	284	STEM 85 X M12	656R	ET153-2	ET153-2
12646GR	495	310	ST1	2244K	ET113	ET113	12717GR	575	352	B1	632RF	ET34	ET34
12648GR	640	385	B2	635RK	ST1	2244K	12718GR	380	265	ET159	-	ET159	-
12650GR	593	364	B2	635RK	B2	635RK	12720GR	600	435	STEM 69 X M14	ST720RK	ET113-1	ET113-1
12652GR	540	333	B1	632RF	B1	632RF	12721GR	607	382	STEM 28 X M14	-	CLEVIS	-



Part Number	Extended (mm)	Compressed (mm)	Upper Mount Type	Upper Replacement	Lower Mount Type	Lower Replacement	Part Number	Extended (mm)	Compressed (mm)	Upper Mount Type	Upper Replacement	Lower Mount Type	Lower Replacement
12722GR	545	343	ET83	-	ET83	-	12757GR	650	390	CB34	-	ET34	-
12725GR	615	460	STEM 56 X M12	-	FORK	-	12759GR	440	277	ST1	2244K	ET17	ET17
12726GR	602	365	ET69	ET69	ET69	ET69	12760GR	495	310	ET177	ET177	ET177	ET177
12727GR	512	378	STEM 65 X M12	ST727RK	ET154	ET154	12764GR	440	307	STEM 70 X M12	-	ET153	ET153
12728GR	608	369	B1	632RF	ET34	ET34	12765GR	625	380	ET163	-	ET163	-
12729GR	550	339	B1	632RF	B1	632RF	12774GR	550	336	ST6	2244AK	CB7	CB7
12729GRP	550	343	B1	632RF	B1	632RF	12775GR	575	357	ET61	-	ET65	-
12730GR	560	425	STEM 68 X M12	ST710RK	ET153-1	ET153-1	12776GR	587	362	ET172	-	CB34	-
12731GR	540	333	ET69	ET69	ET69	ET69	12777GR	587	362	ET172	-	ET172	-
12732GR	580	380	STEM 33 X M12	-	ET162	-	12780GR	613	450	STEM 68 X M12	ST710RK	ET113-1	ET113-1
12735GR	830	667	STEM 35 X M12	-	CLEVIS	-	12781GR	650	384	ST38	ST21RK	ET38-2	ET38-2
12738GR	830	667	STEM 35 X M12	-	CLEVIS	-	12791GR	310	217	ST1	2244K	ET17	ET17
12740GR	452	299	STEM 81 X M12	-	ET158-2	ET158-2	12795GR	447	290	ST21	ST21RK	ET153	-
12742GR	564	356	ST42	-	ET160	ET160	12796GR	619	369	ST21	ST21RK	B2	635RK
12743GR	600	362	ST10	ST10RK	ET38	ET38	12797GR	415	295	STEM 64 X M12	ST710RK	ET153-1	ET153-1
12744GR	609	361	ST10	ST10RK	ET17	ET17	12804GR	535	345	CB159	-	ET38	ET38
12745GR	495	359	STEM 64 X M12	ST710RK	ET153-1	ET153-1	12805GR	570	351	B1	632RF	B2	635RK
12746GR	605	360	ST1	2244K	ET17	ET17	12807GR	451	344	STEM 48 X M10	-	CB160	-
12747GR	625	400	STEM 45 X M14	-	CLEVIS	-	12808GR	673	404	ET164	-	ET164	-
12748GR	711	450	STEM 45 X M14	-	CLEVIS	-	12809GR	461	354	STEM 55 X M10	-	CB160	-
12749GR	530	325	ET69	ET69	B1	632RF	12810GR	605	375	ET164	-	ET164	-
12750GR	562	425	STEM 68 X M12	ST710RK	ET153-3	ET153-3	12811GR	630	390	ET113	-	ST39	ST39
12751GR	575	325	ST38	656RK	ET69	632RF	12812GR	597	375	ST39	-	ET174	ET174
12751LGR	650	382	ST38	656RK	ET69	632RF	12823GR	478	360	STEM 28 X M10	-	ET174	ET174
12752GR	617	374	CB35	CB35	ET69	632RF	12824GR	525	320	STEM 90 X M10	-	ET175	ET175
12752LGR	665	396	CB35	CB35	ET69	632RF	12825GR	545	330	STEM 90 X M10	-	ET175	ET175
12755GR	625	381	ET113	-	ET113	-	12826GR	580	365	ET176	ET176	ET176	ET176
12756GR	432	293	ET173	-	ET173	-	12827GR	496	376	STEM 65 X M12	-	ET155	ET155

# Shock Absorbers



Part Number	Extended (mm)	Compressed (mm)	Upper Mount Type	Upper Replacement	Lower Mount Type	Lower Replacement
24080FE	552	332	ST38	656RK	ST38	656RK
24081FE	631	388	B2	635RK	B2	635RK
24081FEP	631	388	B2	635RK	B2	635RK
24082FE	342	230	ST1	2244K	CB7	CB7
24087FE	349	235	ST1	2244K	ET17	ET17
24088FE	368	246	ST1	2244K	ET113	ET113
24091FE	510	310	ST38	656RK	ST38	656RK
24091FEP	510	310	ST38	656RK	ST38	656RK
24091LFE	557	354	ST38	656RK	ST38	656RK
24091LFE1	597	353	ST38	656RK	ST38	656RK
24091LFEP	557	354	ST38	656RK	ST38	656RK
24094FE	658	402	B2	635RK	B2	635RK
24094LFE	718	429	B2	635RK	B2	635RK
24094LFE1	760	450	B2	635RK	B2	635RK
24094LFEC	718	429	B2	635RK	B2	635RK
24094LFEP	718	429	B2	635RK	B2	635RK
24095FE	630	385	ET104	ET104	ET69	ET69
24635FE	485	310	B1	632RF	B1	632RF
24636FE	587	361	B1	632RF	B1	632RF
24636FEP	587	361	B1	632RF	B1	632RF
24637FE	577	350	ST1	2244K	B2	635RK
24639FE	484	303	ST1	2244K	ET17	ET17
24640FE	564	343	B2	635RK	ST38	656RK
24643FE	412	266	ST6	2244AK	ET17	ET17
24644FE	510	325	ET153	-	ET36	-
24645FE	531	333	B1	632RF	ET142	-
24645FEC	531	333	B1	632RF	ET142	-
24645FES	520	328	B1	632RF	ET142	-
24646FE	495	310	ST1	2244K	ET113	ET113
24648FE	640	385	B2	635RK	ST1	2244K
24650FE	592	366	B2	635RK	B2	635RK
24650FEP	592	366	B2	635RK	B2	635RK
24652FE	540	337	B1	632RF	B1	632RF
24661FE	533	331.5	ST1	2244K	B2	635RK
24665FE	564	346	ST1	2244K	CB7	CB7
24666FE	565	346	CB20	CB20	B5	-
24667FE	382	251	ST1	2244AK	ET17S	ET17S
24682FE	618	373	ST38	656RK	B2	635RK
24682FEC	618	373	ST38-1	ST38-1	ET38	ET38
24682FEP	618	373	ST38-1	ST38-1	ET38	ET38
24682LFE	670	398	ST38	656RK	B2	635RK
24682LFE1	730	428	ST38	656RK	B2	635RK
24683FE	615	365	ST38	656RK	ST38	656RK
24683LFE	670	390	ST38	656RK	ST38	656RK
24683LFE1	730	420	ST38	656RK	ST38	656RK
24691FE	462	343	ST38	656RK	ET153	ET153
24696FE	570	347	ET161	-	ST38	656RK

Part Number	Extended (mm)	Compressed (mm)	Upper Mount Type	Upper Replacement	Lower Mount Type	Lower Replacement
24697FE	520	322	B2	635RK	ST38	656RK
24698FE	626	381	B1	632RF	B1	632RF
24698FEC	626	381	B1	632RF	B1	632RF
24698FEP	626	381	B1	632RF	B1	632RF
24710FE	540	408	STEM 95 X M12	ST710RK	ET153-1	ET153-1
24713FE	470	325	STEM 86 X M10	-	ET158	ET158
24715FE	423	305	STEM 71 X M10	-	ET158-1	ET158-1
24716FE	389	284	STEM 85 X M12	656R	ET153-2	ET153-2
24717FE	577	356	B1	632RF	ET34	ET34
24717FEC	577	356	B1	632RF	ET34	ET34
24717FEP	575	356	B1	632RF	ET34	ET34
24718FE	380	265	ET159	-	ET159	-
24720FE	600	435	STEM 69 X M14	ST720RK	ET113-1	ET113-1
24727FE	512	378	STEM 65 x M12	ST727RK	ET154	ET154
24728FE	608	373	B1	632RF	ET34	ET34
24728FEP	608	373	B1	632RF	ET34	ET34
24729FE	550	348	B1	632RF	B1	632RF
24729FEP	550	348	B1	632RF	B1	632RF
24730FE	560	425	STEM 68 X M12	ST710RK	ET153-1	ET153-1
24732FE	580	374	STEM 33 X M12	-	ET162	-
24740FE	452	299	STEM 81 X M12	-	ET158-2	ET158-2
24742FE	564	356	ST42	-	ET160	ET160
24743FE	600	365	ST10	ST10RK	B2	635RK
24744FE	610	365	ST10	ST10RK	ET17	ET17
24745FE	495	359	STEM 64 x M12	ST710RK	ET153-1	ET153-1
24746FE	605	366	ST1	2244K	ET17	ET17
24750FE	562	425	STEM 68 X M12	ST710RK	ET153-3	ET153-3
24776FE	587	367	ET172	-	CB34	-
24777FE	587	367	ET172	-	ET172	-
24780FE	613	450	STEM 68 x M12	ST710RK	ET113-1	ET113-1
24781FE	650	387	ST38	ST21RK	ET38-2	ET38-2
24788FE	560	341	ET113	-	ST39	ST39
24789FE	576	349	ST39	ST39	ET174	ET174
24795FE	447	290	ST21	ST21RK	ET153	-
24796FE	615	369	ST21	ST21RK	B2	635RK
24804FE	535	345	CB159	-	ET38	ET38
24805FE	570	355	B1	632RF	B2	635RK
24811FE	630	390	ET113	-	ST39	ST39
24812FE	597	375	ST39	ST39	ET174	ET174
24827FE	496	376	STEM 65 XM12	-	ET155	ET155
24840FE	635	450	STEM 31 x M14	-	CLEVIS	-
24842FE	570	375	B2	635RK	B2	635RK
24842FEC	570	375	B2	635RK	B2	635RK
24845FE	517	359	STEM 64 x M12	ST710RK	ET153-1	ET153-1
24851FE	640	456	ET180	-	ET181	-
24852FE	480	491	ET180	-	ET181	-

Part Number	Extended (mm)	Compressed (mm)	Upper Mount Type	Upper Replacement	Lower Mount Type	Lower Replacement	Seal Service Kit	Seat Insulator	Adjusting Rings
45080FE	552	358	ST38	656RK	ST38	656RK	45SK7220		
45081FE	631	400	B2	635RK	B2	635RK	45SK7220		
45081FEC	631	400	B2	635RK	B2	635RK	45SK7220		
45091FE	510	318	ST38	656RK	ST38	656RK	45SK7220		
45091FEP	510	318	ST38	656RK	ST38	656RK	45SK7220		
45091LFE	557	341	ST38	656RK	ST38	656RK	45SK7220		
45091LFE1	597	361	ST38	656RK	ST38	656RK	45SK7220		
45091LFE3	860	492	ST38	656RK	ST38	656RK	45SK7220		
45091LFEP	557	341	ST38	656RK	ST38	656RK	45SK7220		
45094FE	658	416	B2	635RK	ET38	ET38	45SK7220		
45094FEC	658	416	B2	635RK	ET38	ET38	45SK7220		
45094LFE	718	446	B2	635RK	ET38	ET38	45SK7220		
45094LFE1	760	467	B2	635RK	ET38	ET38	45SK7220		
45094LFE3	860	516	B2	635RK	ET38	ET38	45SK7220		
45095FE	630	398	ET104	ET104	ET69	ET69	45SK7220		
45095FEC	630	398	ET104	ET104	ET69	ET69	45SK7220		
45635FE	485	323	B1	632RF	B1	632RF	45SK7220		
45636FE	587	375	B1	632RF	B1	632RF	45SK7220		
45636FEC	587	375	B1	632RF	B1	632RF	45SK7220		
45637FE	577	363	ST1	2244K	B2	635R	45SK7220		
45640FE	564	357	ET38	ET38	ST38	656RK	45SK7220		
45648FE	640	395	B2	635RK	ST1	2244K	45SK7220		
45650FE	592	380	B2	635RK	B2	635RK	45SK7220		
45650FEC	592	380	B2	635RK	B2	635RK	45SK7220		
45650FEP	592	380	B2	635RK	B2	635RK	45SK7220		
45652FE	540	354	B1	632RF	B1	632RF	45SK7220		
45652FEC	540	354	B1	632RF	B1	632RF	45SK7220		
45661FE	533	343	ST1	2244K	ET38	ET38	45SK7220		
45667FE	382	257	ST1	2244K	ET17	ET17	45SK6520		
45682FE	618	383	ST38	656RK	ET38	ET38	45SK7220		
45682FEC	618	383	ST38-1	ST38-1	ET38	ET38	45SK7220		
45682FEP	618	383	ST38-1	ST38-1	ET38	ET38	45SK7220		
45682LFE	670	409	ST38	656RK	ET38	ET38	45SK7220		
45682LFE1	730	439	ST38	656RK	ET38	ET38	45SK7220		
45682LFE3	860	504	ST38	656RK	ET38	ET38	45SK7220		
45683FE	615	370	ST38	656RK	ST38	656RK	45SK7220		
45683LFE	670	397	ST38	656RK	ST38	656RK	45SK7220		
45683LFE1	730	427	ST38	656RK	ST38	656RK	45SK7220		
45691FE	462	342	ST38	656RK	ET153	ET153	45SK6520	45RSS001	45STAR001
45698FE	626	394	B1	632RF	B1	632RF	45SK7220		
45698FEC	626	394	B1	632RF	B1	632RF	45SK7220		
45710FE	540	408	STEM 95 x M12	ST710RK	ET153-1	ET153-1	45SK6520	45RSS001	45STAR001
45715FE	442	315	STEM 71 X M10	-	ET158-1	ET158-1	45SK6520	45RSS001	45STAR001
45716FE	389	283	STEM 86 x M12	656RK	ET153-2	ET153-2	45SK7220	45RSS004	45STAR002
45716LFE	402	287	STEM 86 x M12	656RK	ET153-2	ET153-2	45SK7220	45RSS004	45STAR002

# Shock Absorbers



Part Number	Extended (mm)	Compressed (mm)	Upper Mount Type	Upper Replacement	Lower Mount Type	Lower Replacement	Seal Service Kit	Seat Insulator	Adjusting Rings
45717FE	572	373	B1	632RF	ET34	ET34	45SK7220		
45717FEC	572	373	B1	632RF	ET34	ET34	45SK7220		
45720FE	600	435	STEM 71 x M14	ST720RK	ET113-1	ET113-1	45SK7218	45RSS002	45TAR002
45727FE	512	378	STEM 65 x M12	ST727RK	ET154	ET154	45SK7220	45RSS005	45TAR002
45728FE	608	389	B1	632RF	ET34	ET34	45SK7220		
45728FEC	608	389	B1	632RF	ET34	ET34	45SK7220		
45729FE	445	372	B1	632RF	B1	632RF			
45729FEC	445	372	B1	632RF	B1	632RF			
45729FEP	445	372	B1	632RF	B1	632RF			
45730FE	560	425	STEM 68 X M12	ST710RK	ET153-1	ET153-1	45SK6520	45RSS001	45TAR001
45732FE	580	380	STEM 33 X M12	-	ET162	-	45SK7218		
45732FEC	580	380	STEM 33 X M12	-	ET162	-	45SK7218		
45740FE	452	302	STEM 81 x M12	-	ET158-2	ET158-2	45SK7220	45RSS003	45TAR002
45742FE	564	357	ST42	-	ET160	ET160	45SK7220		
45743FE	600	376	ST10	ST10RK	ET38	ET38	45SK7220		
45744FE	610	379	ST10	ST10RK	ET17	ET17	45SK7220		
45745FE	495	359	STEM 64 x M12	ST710RK	ET153-1	ET153-1	45SK6520	45RSS001	45TAR001
45746FE	605	397	ST1	2244K	ET17	ET17	45SK6520		
45746FEC	605	397	ST1	2244K	ET17	ET17	45SK6520		
45750FE	562	425	STEM 68 x M12	ST710RK	ET153-3	ET153-3	45SK6520	45RSS001	45TAR001
45751FE	575	361	ST38	656RK	B1	632RF	45SK7220		
45751LFE	650	399	ST38	656RK	B1	632RF	45SK7220		
45752FE	617	393	CB35	CB35	B1	632RF	45SK7220		
45752LFE	665	417	CB35	CB35	B1	632RF	45SK7220		
45780FE	613	450	STEM 68 X M12	ST710RK	ET113-1	ET113-1	45SK7218	45RSS002	45TAR002
45781FE	650	401	ST21	ST21RK	ET38-2	ET38-2	45SK7220		
45795FE	447	295	ST21	ST21RK	ET38-1	ET38-1	45SK7220		
45796FE	615	401	ST21	ST21RK	ET38	ET38	45SK7220		
45796FEP	615	401	ST21	ST21RK	ET38	ET38	45SK7220		
45802FE	755	471	ET165	-	ET165	-	45SK7220		
45802LFE	860	524	ET165	-	ET165	-	45SK7220		
45803FE	710	449	ET165	-	ET165	-	45SK7220		
45827FE	496	376	STEM 65 X M12	-	ET155	ET155	45SK7218	45RSS005	45TAR002
45845FE	517	359	STEM 64 x M12	ST710RK	ET153-1	ET153-1	45SK6520	45RSS001	45TAR001
45851FE	640	456	ET180	-	ET181	-	45SK6520		
45851FEC	640	456	ET180	-	ET181	-	45SK6520		
45852FEC	640	498	ET180	-	ET181	-	45SK6520		
45854FE	678	446	ET153-1	-	ET153-1	-	45SK7220		
45854FEC	678	446	ET153-1	-	ET153-1	-	45SK7220		
45854FEP	678	446	ET153-1	-	ET153-1	-	45SK7220		
45855FE	542	389	STEM x 30 x M12	-	CLEVIS 72.5 x 16.5	-	45SK6520		
45855LFE	558	389	STEM x 30 x M12	-	CLEVIS 72.5 x 16.5	-	45SK6520		
45856FE	678	446	ET153-2	ET153-2	ET153-3	-	45SK7220		
45856FEC	678	446	ET153-2	ET153-2	ET153-3	-	45SK7220		
45856LFE	700	457	ET153-2	ET153-2	ET153-3	-	45SK7220		
45856LFEC	700	457	ET153-2	ET153-2	ET153-3	-	45SK7220		



Make	To Suit Model	Part No.	OEM Spring Seat Height
To Suit Ford	To Suit Ranger PX, PX II	<b>45727FE</b>	190mm
	To Suit Ranger PX III	<b>45827FE</b>	166mm
To Suit Holden	To Suit Colorado / Trailblazer	<b>45745FE</b>	190mm
To Suit Isuzu	To Suit D-Max	<b>45745FE</b>	190mm
	To Suit D-Max	<b>45845FE</b>	195mm
To Suit Mazda	To Suit BT50	<b>45727FE</b>	190mm
To Suit Mercedes	To Suit X-Class	<b>45716FE</b>	105mm
To Suit Mitsubishi	To Suit Triton	<b>45715FE</b>	210mm
To Suit Nissan	To Suit Navara D40	<b>45716FE</b>	105mm
	To Suit Navara NP300	<b>45716FE</b>	105mm
	To Suit Patrol Y62	<b>45740FE</b>	130mm

Make	To Suit Model	Part No.	OEM Spring Seat Height
To Suit RAM	To Suit RAM 1500 DS	<b>45855FE</b>	185mm
To Suit Renault	To Suit Alaskan	<b>45716FE</b>	105mm
To Suit Toyota	To Suit Prado 90 / 95	<b>45691FE</b>	163mm
	To Suit Hilux / Fortuner 2005-2014	<b>45710FE</b>	229mm
	To Suit Hilux / Fortuner 2015+	<b>45730FE</b>	224mm
	To Suit Prado 120	<b>45710FE</b>	214mm
	To Suit Prado 150 2009-10/2017	<b>45750FE</b>	214mm
	To Suit Prado 150 11/2017+	<b>45710FE</b>	214mm
	To Suit FJ Cruiser / Tacoma	<b>45710FE</b>	214mm
	To Suit Landcruiser 200	<b>45720FE</b>	220mm
	To Suit Tundra	<b>45780FE</b>	245mm with TOY063 Coil

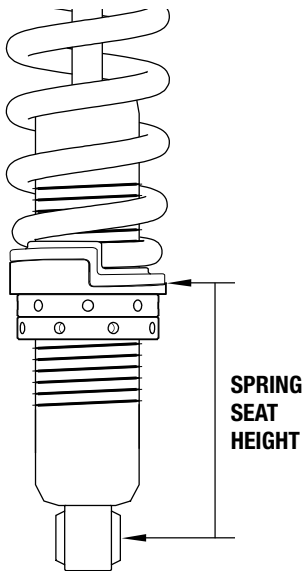

Foam Cell Pro Struts feature a threaded body for ride height adjustment. Use Ironman 4x4, P/N# ISHOCKTOOL001 wrench when making adjustments. It may be necessary to unload the spring tension before making adjustments.

When setting ride height use the OEM shock absorber as a reference for spring seat height, or refer table above.

Many independent suspension systems incorporating struts operate at a 2:1 motion ratio. For every 1mm of movement (compression or extension) at the strut, equates to 2mm movement when measured at the wheel. This **MUST** be considered when adjusting seat height. For example a 10mm seat height adjustment will provide 20mm change in ride height.

Independent suspension **MUST** maintain at least 60mm downward travel from ride height. Raising ride height too high can damage the suspension components, impair suspension operation and safety.



*ISHOCKTOOL001 Multi-tool for shock absorber service and strut ride height adjustment*



# Steering Dampers

## STEERING DAMPER MEASUREMENT REFERENCE

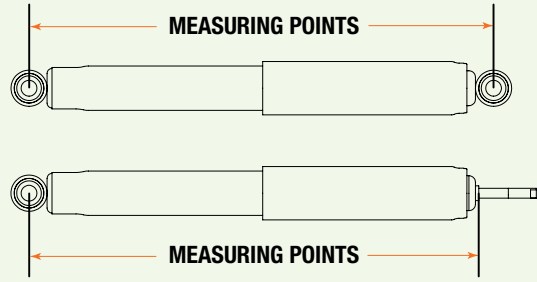

Part Number	Extended (mm)	Compressed (mm)	Upper Mount Type	Upper Replacement	Lower Mount Type	Lower Replacement
3501	550	345	B9	B9MK	B9	B9MK
3502	655	394	ET65	-	ET65	-
3511	525	310	ST1	2244K	ST1	2244K
3517	609	368	B6	-	B6	-
3521	540	340	ST1	2244K	B9	B9MK
3521S	487	293	ST1	2244K	ST1	2244K
3522	541	331	B1	632RF	B1	632RF
3523	458	322	B9	B9MK	B9	B9MK
3524	648	423	B9	B9MK	B9	B9MK
3525	748	443	B9	B9MK	B9	B9MK

Part Number	Extended (mm)	Compressed (mm)	Upper Mount Type	Upper Replacement	Lower Mount Type	Lower Replacement
3530	445	290	ET17	ET17	ET17	ET17
3532	677	439	ST1	2244K	ET57	-
3533	613	368	ET109	-	B9	B9MK
3534	577	350	ET17	ET17	B1	632RF
3536	487	292	ST1	2244K	ST1	2244K
3540	480	298	B1	632RF	ET65	-
3541	528	332	ET65	-	ET65	-
3542	622	419	ET17	-	B1	-
3543	725	520	ET65	-	ET65	-
3544	535	338	ET65	-	ET65	-

# Shock Absorber Mount Types

## SHOCK ABSORBER MOUNTS MEASUREMENT REFERENCES

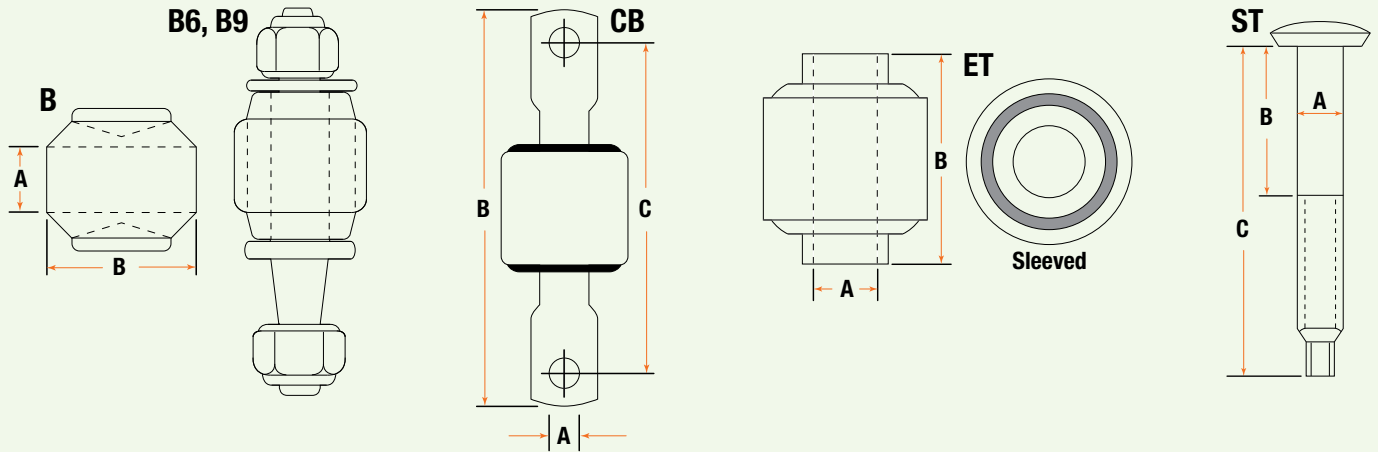

Type	A Diameter	B Length	
B1	16	36	
B2	19	43.5	
B5	15.5	33	
B6	16	36	Adaptor
B9	16	36	Adaptor
<b>CB</b>			
CB20	13	95	77
CB34	11	97	75
CB35	10	90	80
CB7	11.5	78	62
CB159	10	116	95.5
CB160	11.5	128	100
<b>ET</b>			
ET104	20	43	
ET109	10	24.1	
ET113	16	38.5	
ET113-1	16	38.5	Sleeved
ET141	12	41	
ET142	16	36.5	
ET153	14	40	Sleeved
ET153-1	14	40	Sleeved
ET153-2	14	41.5	Sleeved
ET153-3	14	41.5	Sleeved
ET154	16	38	Sleeved
ET155	20	49.5	Sleeved
ET158	14	50	Sleeved
ET158-1	14	50	Sleeved
ET158-2	14	50	Sleeved
ET159	14	48	Sleeved
ET160	14	53	Sleeved
ET161	16	70	
ET162	14	61.5	Sleeved

Type	A Diameter	B Length	
ET163	16	32.5	Sleeved
ET164	14.5	43	
ET165	20	55	
ET17	12	31.5	
ET172	12.4	43.5	
ET173	13	42.5	
ET174	12	38	Sleeved
ET175	12.2	38	Sleeved
ET176	16	38	
ET177	12	32	Sleeved
ET180	13	70	
ET181	13	40	
ET19	12	46	
ET24	12.5	36	
ET34	14	41.5	
ET36	19	44	
ET38	19	45.5	
ET38-1	14	38	
ET38-2	12	39	
ET57	10	26.1	
ET61	12	46	
ET65	12	36	Sleeved
ET69	12	40	Sleeved
ET83	12	37.5	Sleeved
<b>ST</b>			
ST1	10	26	60
ST10	12	39	64
ST21	17	59	84
ST38	14	43	70
ST38-1	14	43	70
ST42	Rectangle M12	44	80
ST6	11	34	65

# Trim Packers

## TRIM PACKER MEASUREMENT REFERENCE

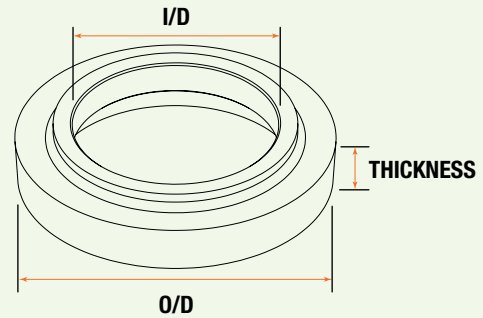

Part Number	O/D	I/D	Thickness	Material
HILFR05	63	54.5	5	Steel
HILFR05F	63	60.5	5	Steel
HILFR10	63	54.5	10	Steel
HILFR10F	63	60.5	10	Steel
HILFR15	63	54.5	15	Steel
HILFR15F	63	60.5	15	Steel
LC70F30	138	86	30	Polyurethane
LCF20	160	114.5	20	Polyurethane
LCF30	160	114.5	30	Polyurethane

Part Number	O/D	I/D	Thickness	Material
LCPR20	168	108	20	Polyurethane
LCPR25	168	108	25	Polyurethane
LCR15	187	133.5	15	Polyurethane
LCR30	187	133.5	30	Polyurethane
PATF15	172	116	15	Polyurethane
PATF30	172	116	30	Polyurethane
PATR15	180	120	15	Polyurethane
PATR30	180	120	30	Polyurethane

# U-Bolts and Load Plus Helper Springs

## U-BOLTS MEASUREMENT REFERENCE

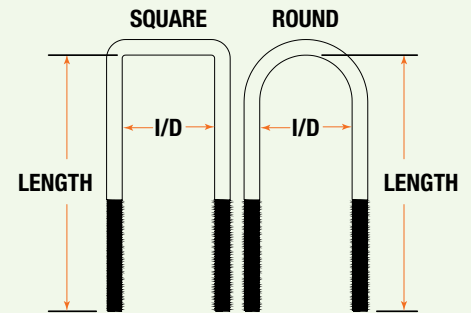

Part Number	Type	Length	I/D	Thread	Tension Nm
415UBK	Round	215	83	M14 X 1.5 X 100	125
416UBK	Round	230	83	M14 X 1.5 X 100	125
416UBKL	Round	250	83	M14 X 1.5 X 100	125
417UBK	Round	220	88	M14 X 1.5 X 80	125
436UBK	Square	230	73	M14 X 1.5 X 100	125
437UBK	Square	175	62	M14 X 1.5 X 100	125
437UBKL	Square	190	62	M14 X 1.5 X 100	125
449UBK	Square	230	83	M14 X 1.5 X 100	125
451UBK	Round	190	75	M12 X 1.5 X 75	75
452UBK	Square	120	63	M12 X 1.5 X 75	75
453UBK	Round	230	97	M14 X 1.5 X 100	125
512UBK	Round	160	70	M12 X 1.5 X 65	75
654UBK	Round	165	82	M12 X 1.5 X 75	75

Part Number	Type	Length	I/D	Thread	Tension Nm
655UBK	Round	140	70	M12 X 1.5 X 65	75
668UBK	Square	230	73	M14 X 1.5 X 100	125
669UBK	Square	230	73	M14 X 1.5 X 100	125
670UBK	Round	230	95	M14 X 1.5 X 100	125
678UBK	Square	200	62	M14 X 1.5 X 70	125
788UBK	Square	190	63	M12 X 1.25 X 65	75
1100UBK	Round	230	110	M14 X 1.5 X 100	125
1100UBKL	Round	265	110	M14 X 1.5 X 100	125
1102UBK	Square	155	72	M12 X 1.5 X 65	75
1103UBK	Round	185	72	M14 X 1.5 X 100	125
1104UBK	Round	200	83	M14 X 1.5 X 100	125
1106UBK	Square	205	92	M14 X 1.5 X 75	125

## LOAD PLUS HELPER SPRINGS

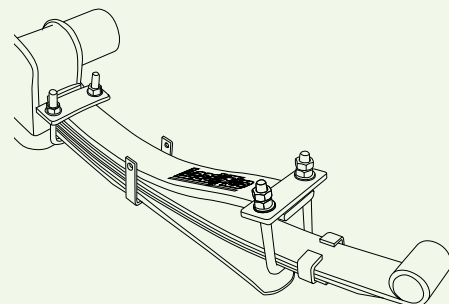

Part Number	Width	Thickness	Length	Mounting Kit	U-Bolt
LP1	60	12	425	LP3-1	LP3-2
LP2	60	12	420	LP3-1	LP3-2
LP3	60	12	442	LP3-1	LP3-2
LP4	70	12	442	LP4-1	LP4-2

Part Number	Width	Thickness	Length	Mounting Kit	U-Bolt
LP5	50	8	310	LP5-1	LP5-2
LP7	75	12	438	LP7-1	LP7-2
LP9	70	16	435	LP9-1	LP9-2

# Suspension Arm Rubber Bush Kits

## WITH STANDARD RADIUS ARM BUSHES

Model	Part Number	Contents	Position	Qty Per Kit
TO SUIT NISSAN PATROL Y60 GQ 1989 - On TO SUIT NISSAN PATROL Y61 GU WAGON Pre 2/2000	<b>839RK</b>	<b>832RT</b>	Radius Arm - Diff	4
		<b>833R</b>	Radius Arm Chassis	4
		<b>836RT</b>	Trailing Arm	8
		<b>834RT</b>	Panhard Rod - Chassis	2
		<b>840RT</b>	Panhard Rod - Diff	2
TO SUIT NISSAN PATROL Y61 GU WAGON 2/2000 - On	<b>848RK</b>	<b>832RT</b>	Radius Arm - Diff	4
		<b>833R</b>	Radius Arm Chassis	4
		<b>836RT</b>	Trailing Arm	8
		<b>848RT</b>	Panhard Rod - Chassis	2
		<b>840RT</b>	Panhard Rod - Diff	2
TO SUIT TOYOTA LANDCRUISER 80/105	<b>847RK</b>	<b>832RT</b>	Radius Arm - Diff	4
		<b>846RT</b>	Radius Arm Chassis	2
		<b>844RT</b>	Trailing Arm Upper	4
		<b>843RT</b>	Trailing Arm Lower	4
		<b>841RT</b>	Front Panhard Rod	2
		<b>845RT</b>	Rear Panhard Rod	2

## WITH 2° OFFSET RADIUS ARM BUSHES

Model	Part Number	Contents	Position	Qty Per Kit
TO SUIT NISSAN PATROL Y60 GQ 1989 - On TO SUIT NISSAN PATROL Y61 GU WAGON Pre 2/2000	<b>839CRK</b>	<b>1144R</b>	Radius Arm - Diff Offset	4
		<b>833R</b>	Radius Arm Chassis	4
		<b>836RT</b>	Trailing Arm	8
		<b>834RT</b>	Panhard Rod - Chassis	2
		<b>840RT</b>	Panhard Rod - Diff	2
TO SUIT NISSAN PATROL Y61 GU WAGON 2/2000 - On	<b>848CRK</b>	<b>1144R</b>	Radius Arm - Diff Offset	4
		<b>833R</b>	Radius Arm Chassis	4
		<b>836RT</b>	Trailing Arm	8
		<b>848RT</b>	Panhard Rod - Chassis	2
		<b>840RT</b>	Panhard Rod - Diff	2
TO SUIT TOYOTA LANDCRUISER 80/105	<b>847CRK</b>	<b>1144R</b>	Radius Arm - Diff Offset	4
		<b>846RT</b>	Radius Arm Chassis	2
		<b>844RT</b>	Trailing Arm Upper	4
		<b>843RT</b>	Trailing Arm Lower	4
		<b>841RT</b>	Front Panhard Rod	2
		<b>845RT</b>	Rear Panhard Rod	2



# STRUT COMPRESSOR

Part No. IBSC7600

## Ironman 4x4 Strut Compressor

by **Branick**

*Ironman 4x4 have teamed with Branick to bring you the industry leading 7600 model strut compressor. The 7600 is the top of the line strut compressor and provides a safe and efficient way to assemble and disassemble struts.*

### Key Features:

- *Increases workshop profitability*
- *Safer and easier than alternate methods*
- *Handles the heaviest 4WD struts*
- *Has long handles for extra torque*
- *Multi-position spring hooks*
- *Has a long compression stroke*
- *Does not require adapters*
- *Heavy duty acme thread*
- *Versatile mounting options*
- *All-steel construction*
- *Increase productivity*
- *Made in USA*



**SAFER, STRONGER, SMARTER**

+61 3 9532 1111  
[www.ironman4x4.com](http://www.ironman4x4.com)

# FAQ / Troubleshooting

## Can I assemble struts at home?

In most cases, no. Ironman 4x4 recommend strut assembly be performed only by a qualified automotive mechanic using specialised strut compressor equipment.

Assembled struts store large amounts of sprung energy. Only mechanics with necessary tools and equipment should attempt to disassemble or assemble a strut. Mishandling of strut assemblies can result in severe injury or death.

Never loosen or remove strut centre top nut until all spring energy is retained within a high quality strut compressor.

## The shock absorber appears to be leaking.

Upon initial use, there may be an oily residue or a small amount of oil originating from the rod seal and surrounding parts, this is referred to as manufacturing overflow.

Oil can be trapped in the seal during assembly and released during transport or initial operation. This is considered normal and should be wiped clean prior to installation or after first use. If oil continues to appear, the shock absorber may be leaking and it should be replaced.

## The shock absorber does not self-extend with gas pressure.

Ironman 4x4 Nitro Gas shock absorbers will self-extend due to pressurised nitrogen gas contained within, the rate of gas extension offers little relevance in determining the health or performance of the shock absorber.

Ironman 4x4 Foam Cell shock absorbers will NOT self-extend like a gas pressurised shock absorber as they do not contain gas pressure - A Foam Cell shock absorber will generally feel firmer to extend than it will to compress.

If a gas shock absorber fails to self-extend, this may not indicate a problem, it may simply be due to a dry or dirty piston rod, firm valving resistance or due to low gas pressure design. This does not adversely affect performance.

Avoid removing the thin film of oil from the piston rod, it is required for smooth seal operation and lubrication. A light oil may be used to rejuvenate the seal if a squeak is present.

## The shock absorber appears damaged.

All Ironman 4x4 shock absorbers are twin tube construction, this means they are very resilient to damage from rocks and debris. The outer tube can tolerate dents providing no puncture exists, the shock absorber will still function as intended.

Do not allow mud or debris to accumulate for extended periods around suspension components, clean and rinse as soon as practical.

Dust shields or rubber protective boots are provided by Ironman 4x4 to protect the piston rod from rock and debris damage.

Spare parts such as bushes, boots and dust shields are often available as spare parts if required.

## The lower strut bushes have perished.

This is most likely as a result of the bushes being tightened without neutralisation.

Never tighten shock absorber bushes until the vehicle is lowered to the ground.

Leave eye ring mounts finger tight ONLY, until the vehicle is lowered to the ground at normal ride height, failure to do this can damage the rubber bond due to twisting resulting in premature bush wear.

This is particularly important for load bearing lower strut bush applications.

Once the vehicle is lowered to the ground, only then tighten to specified tensions.

## Can I re-use my original rubber spring bushes?

Ironman 4x4 always recommends to renew leaf spring bushes with polyurethane when new springs are fitted. The extended range of travel provided by Ironman leaf springs and longer shock absorbers can over-rotate and damage the rubber material. In all cases when a silent block press fit bush is used, it cannot be transferred to an Ironman 4x4 leaf spring.

Original two-piece rubber bushes will fit Ironman 4x4 leaf springs, however it is not recommended. When greased, polyurethane allows greater rotational freedom on the shackles pins when compared to rubber.

## Does polyurethane require re-greasing?

Yes, polyurethane bushes should be re-greased as part of a regular maintenance schedule.

Ironman 4x4 recommend a Molybdenum Disulphide based grease or other grease specified for use with polyurethane.

## Can I use Ironman 4x4 shock absorbers with original springs?

Yes, in all cases. (Except those specified for racing or offroad only applications such as 4" or 6" lift). Ironman 4x4 design all suspension components to be compatible with OEM suspension components.

For optimal performance, Ironman 4x4 do recommend Ironman 4x4 shock absorbers are fitted as part of an integrated suspension system comprising Ironman 4x4 springs.

## Can I use Ironman 4x4 springs with original shock absorbers?

Yes, in all cases. (Except those specified for racing or offroad only applications such as 4" or 6" lift). Ironman 4x4 design all suspension components to be compatible with OEM suspension components.

For optimal performance, Ironman 4x4 do recommend Ironman 4x4 springs are fitted as part of an integrated suspension system comprising Ironman 4x4 shock absorbers.

## The springs appear to be sagging.

Refer to completed installation form to measure and compare with new ride height.

Ironman 4x4 design an array of different springs to suit different load applications. It is imperative the correct spring is selected for the expected loads.

Installing a spring which is too soft for the load will result in loss of expected ride height. Installing a spring which is too strong for the load will result in excessive ride height.

To properly determine whether a spring has sagged or is under-specified, the spring must be removed from the vehicle and free height checked against the original specification found in suspension catalogue.

Depending on spring size and rate, a loss of up to 10mm due to natural steel relaxation is considered normal.

Natural settling is expected within the first 2-3 months, after which the springs are expected to maintain height.

If a spring has lost more than 10mm free height from new, they may require replacement.



## FAQ / Troubleshooting

**The vehicle is leaning to one side.**

Refer to completed installation form to measure and compare with new ride height.

If a vehicle is leaning down on one corner, firstly ensure the vehicle is on level ground and then assess the weight distribution to ensure even placement of load and accessories.

Many vehicle models exhibit an uneven weight distribution from factory, Ironman 4x4 adjust the spring height accordingly to level the vehicle.

Check if springs are designated for Drivers Side (D/S) or Passengers Side (N/S) and ensure they are installed to the correct location.

Typically the taller coils should be fitted to the heavier side of the vehicle.

**The vehicle is leaning towards front or back.**

Refer to completed installation form to measure and compare with new ride height.

Typically if the vehicle is level from side to side, but down at front or back, indicates incorrect spring selection. Check springs are correctly specified to match the load and accessories.

Vehicles which feature independent suspension are generally subject to a 2:1 motion ratio, meaning that for every 1mm of movement at the spring, the ride height is affected 2mm.

This is particularly important when assessing spring settling or sag. Natural settling of 10mm at the spring will result in 20mm setting of ride height. Settling of new rubbers and bushes should also be factored as they will contribute a few additional mm.

**The shock absorber feels too soft or inconsistent when compressed.**

Prime the shock absorber by fully pumping it upright 2-3 times, ensuring the pressure chambers are fully purged of gas or air bubbles.

The shock absorber will generally feel firmer to extend than it will to compress.

**The ride height is too high or banging over bumps.**

Independent suspension operates with limited wheel travel. Ironman 4x4 design springs to increase the ride height a prescribed amount within the safe limits of the original vehicles design.

If incorrectly specified springs or additional spacers are fitted, the ride height may be excessive causing the strut to reach its upper limit "top out" during motion.

As a general rule, Ironman 4x4 recommend a MINIMUM of 60mm downward travel available in the suspension, otherwise referred to as "droop".

To establish ride height in relation to maximum height, a droop measurement will be required.

**DROOP MEASUREMENT**

- 1) Measure and record the vertical rim to guard distance with the vehicle on flat level ground.
- 2) Raise and support the vehicle with front or rear wheels hanging.
- 3) Measure and record the vertical rim to guard distance with the wheels fully hanging.

The difference between the two measurements is the amount of downward droop the suspension has available to it.

The minimum droop distance should be no less than 60mm fully settled.

If droop is less than 60mm, a reduction in handling performance will be experienced, possibility of damage to suspension, driveline and tyre wear can be a factor. In this case the ride height must be lowered.

**There is a squeak coming from the suspension.**

A squeak can originate from any number of sources or for many reasons. The most effective method to diagnose and resolve a squeak is to perform a systematic approach to locating the source. Make note of what conditions cause the squeak, ie. large bumps, small bumps, wet weather, cornering etc. Also note the type of noise whether it appears to be from a soft rubber / plastic origin or hard steel origin.

Attempt should be made to simulate the condition, such as bouncing the vehicle whilst listening to locate the source, it may be required to enlist a second person to bounce the vehicle whilst another accesses the underneath of the vehicle closely to pin point the exact location.

**Typical sources for noise include:**

Dry or broken bushes  
Loose or misaligned components  
Bent or damaged components  
Steel to Steel friction  
Under-tensioned bolts

**The suspension appears to be rusty.**

In many cases, damage to spring or shock absorber coating is unavoidable due to impacts with stones and debris. In some instances light surface rusting may appear on exposed steel if coating becomes damaged. This will not affect the performance of the product however may be unsightly. Take care when using a high pressure washer or strong chemicals during cleaning as this can further compromise the coating leading to greater exposure.

Care should be taken during installation to ensure components are not scratched or damaged which may result in exposure of the underlying steel.

Vehicles operating in salty environments may experience further accelerated surface rusting.

**There is a vibration after fitting the suspension.**

This is a known issue in some vehicles after ride height has been raised. It is caused by the change in angle within the driveline, most commonly in vehicles with 2 piece driveshafts.

In many cases where vibration is a common factor, Ironman 4x4 offer a solution such as a driveline spacer kit to adjust the angles of the driveshaft. The spacer kits are used to adjust the location of the centre bearing with view to reduce the vibration to a satisfactory level.

Each vehicle can vary in severity, some may not be fully rectified after the re-alignment. In such cases axle wedges or a reduction in ride height may be required.

**Can I adjust the strut seat height?**

Ironman 4x4 struts feature an adjustable height spring seat. 12xxx & 24xxx series struts utilise a trim packer system, 45xxx series struts utilise a threaded strut body.

Seat height cannot be adjusted whilst in vehicle, strut must be removed from vehicle with spring tension unloaded to enable adjustment.

The purpose of this adjustment feature is to allow recalibration of ride height following the installation of heavy accessories or to compensate spring settling.

Not to be used as a variable ride height system.

An increase in seat height beyond OEM specifications may result in excessive lift and non-compliance to state or federal laws.

A minimum 60mm suspension droop must be available at all times.

**SLIDE AWAY**



WEATHERPROOF

REMOTE CONTROLLED

SECURE STORAGE



for a full range of 4x4 accessories visit our website

[www.ironman4x4.com](http://www.ironman4x4.com)



# ***Accessories Selection and Information***

***Effective 1 November 2021***





# Features and Benefits

## COMMERCIAL BULL BAR



Australian Designed and Engineered.

Styled around the contours of the vehicle.

Tested in Australia and complies to ADRs and airbag compatibility.

Designed to ensure maximum strength, protection and improved approach angle.

Winch compatible on separate winch cradle removing excess weight off the bar and reducing weight on the front suspension.

An improved level of occupant safety from animal strikes.

Made using the highest quality SPHC oil and pickled steel.

Robot welded together for ultimate strength and accuracy.

### **Bar comprises of the following features**

A-Frame 50mm triple loop design, integrated LED parker and indicator, high lift jack points, aerial tab. Driving light mounting locations. Reinforced front centre and side wing for protection.

The Ironman 4x4 commercial bar is perfect for the customer who wants maximum protection without the option of fog lights. Perfect for the avid 4wder, daily driver or fleet buyer.

## COMMERCIAL DELUXE BULL BAR



Australian Designed and Engineered.

Styled around the contours of the vehicle.

Tested in Australia and complies to ADRs and airbag compatibility

Designed to ensure maximum strength, protection and improved approach angle.

Winch compatible on separate winch cradle removing excess weight off the bar and reducing weight on the front suspension.

An improved level of occupant safety from animal strikes.

Made using the highest quality SPHC oil and pickled steel.

Robot welded together for ultimate strength and accuracy.

### **Bar comprises of the following features**

A-Frame 50mm triple loop design, integrated LED parker and indicator, fog light and loom, high lift jack points, aerial tab. Driving light mounting locations. Reinforced front centre and side wing for protection.

The Ironman 4x4 commercial deluxe bar is perfect for the customer who wants maximum protection with the option of a fog lights. Perfect for owner wanting a more styled protective option whilst maintaining or adding fog lights.

## PROTECTOR BULL BAR



Australian Designed and Engineered.

Styled around the contours of the vehicle.

Tested in Australia and complies to ADRs and airbag compatibility.

Designed to ensure maximum strength, protection and improved approach angle.

Winch compatible on separate winch cradle removing excess weight off the bar and reducing weight on the front suspension.

An improved level of occupant safety from animal strikes.

Made using the highest quality SPHC oil and pickled steel.

Robot welded together for ultimate strength and accuracy.

Bolt on 304 stainless steel loops.

### **Bar comprises of the following features**

Bolt on triple loops 75mm centre and 50mm outer loops, integrated LED parker and indicator, fog light and loom, high lift jack points, aerial tab. Driving light mounting locations. Reinforced front centre and side wing for protection.

The Ironman 4x4 protector bar is perfect for the customer who wants maximum protection with the option of a fog lights and with the shine of stainless steel loops. Perfect for owner wanting a to match the chrome highlights on their vehicle whilst maintaining protection.

## PROGUARD NO LOOP BULL BAR



Australian Designed and Engineered.

Styled around the contours of the vehicle.

Tested in Australia and complies to ADRs and airbag compatibility

Designed to ensure maximum strength, protection and improved approach angle.

Winch compatible on separate winch cradle removing excess weight off the bar and reducing weight on the front suspension.

An improved level of occupant safety from animal strikes.

Made using the highest quality SPHC oil and pickled steel.

Robot welded together for ultimate strength and accuracy.

Features no loops for a bumper replacement look.

### **Bar comprises of the following features**

Lower bull bar section only, integrated LED parker and indicator, fog light and loom, high lift jack points, Driving light mounting locations. Reinforced front centre and side wing for protection.

The Ironman 4x4 proguard bar is perfect for the customer who wants some protection with the option of a fog lights but without the addition of full loops. Single or triple stainless-steel loops can be added for increased protection. Perfect for owner wanting a look of a bumper replacement bar but with the option to add to the bar with different loops.

# Features and Benefits

## PREMIUM COMMERCIAL DELUXE BULL BAR



Australian Designed and Engineered.

Styled around the contours of the vehicle.

Tested in Australia and complies to ADRs and airbag compatibility.

Designed to ensure maximum strength, protection and improved approach angle.

Winch compatible on separate winch cradle removing excess weight off the bar and reducing weight on the front suspension.

An improved level of occupant safety from animal strikes.

Made using the highest quality SPHC oil and pickled steel.

Robot welded together for ultimate strength and accuracy.

Designed for the larger 4wds.

### Bar comprises of the following features

A-Frame 60mm triple loop design, integrated LED parker and indicator, metal fog light surround with fog lights and loom, high lift jack points, 3 aerial tabs. Driving light mounting locations. Reinforced front centre and side wing for protection.

The Ironman 4x4 Premium deluxe bar is perfect for the customer who wants maximum protection with the option of a fog lights. Perfect for owner of a larger 4wd wanting a more protection coverage and a larger tube size.

## POLISHED ALLOY BULL BAR



Australian Designed and Engineered.

35% less weight than steel bull bar.

Styled around the contours of the vehicle.

Tested in Australia and complies to ADRs and airbag compatibility

Designed to ensure maximum strength, protection and improved approach angle.

Winch compatible on separate winch cradle removing excess weight off the bar and reducing weight on the front suspension.

An improved level of occupant safety from animal strikes.

Made using the highest quality 5052 Aluminium.

Welded together for ultimate strength and accuracy.

### Bar comprises of the following features

Triple loops 75mm centre and 50mm outer loops, integrated LED parker and indicator, fog lights and loom, 2 aerial tabs. Driving light mounting locations. Reinforced front centre and side wing for protection.

The Ironman 4x4 Polished alloy bar is perfect for the customer who wants maximum protection with advantage of less weight. The Polished alloy bar weighs 35% less when compared to steel bars.

## PROGUARD SINGLE OR TRIPLE LOOP



Add to the Proguard no loop bull bar for increased protection, style and for aesthetics.

75mm 304 stainless steel tubing centre loop can be added for added styling to complement any vehicle and increase protection in the centre of the vehicle.

The triple loop design is made up of 75mm centre loops with 50mm outer loops out of 304 stainless steel. The triple loops can be added for added styling to complement any vehicle and increase protection across the full front of the vehicle.

### Includes

Centre loop bar and overriders.

## RECOVERY POINTS



A rated recovery point is an essential accessory for any 4wd. Designed in Australia tested and approved to ensure the safest connection point on the vehicle for a recovery.

Designed using 12mm steel with elongated hole to allow a rated shackle or soft shackle to pass through, allowing the strap to be on the correct angle.

Powder coated Red for quick and easy identification with safety instructions on each point. Rated at 5000kgs, the rated recovery points can be used with an equalisation strap allowing load distribution across both points.

## SIDE STEPS



Side steps provide a stronger step option that bolt to the chassis and not the body. The steel steps Allows for easy access to vehicle.

Premium Steel Construction - Made from the highest quality SPHC oil and pickled steel for maximum strength and resistance to rust.

Heavy duty black powder coated checkerplate tread is not only stylish, but practical and durable.

Newer Hybrid Design - Allows for the addition of side rails at a later point

Can be colour coded to match vehicle paint colour.

## SIDE RAILS



Designed to be added to the Ironman 4x4 side step range for complete sill, door and panel protection.

Premium Steel Construction - Made from the highest quality SPHC oil and pickled steel for maximum strength and resistance to rust.

Heavy duty black powder coating is practical and durable, or can be colour coded to match vehicle paint colour. Easily attach to Ironman 4x4 hybrid side steps and most bull bars on the market.

# Features and Benefits

## SNORKELS

Snorkels provide cleaner, dryer and cooler air to the vehicles engine. By raising the height of the vehicles air intake, this also allows for safer water crossings. The ram head forces air into the airbox and deflects any rain, forcing the rain to the outer edges, allowing the rain to exit at the head level and not enter the airbox.



Heavy Duty Construction - Made from the highest quality LLPE and has the highest UV rating for harsh outback environments.

3D Scanned and Designed - Ensures the snorkel complements the contour lines of your vehicle.

## CANVAS SEAT COVERS

Tailored - Comfort canvas seat covers to suit most off-road vehicles



Highest quality manufacturing - Made from 12oz, 100% cotton natural fibre canvas that is water, mud and fire resistant

Cushioning Foam - Adds an extra level of - Comfort with the added extra layer of cushioning foam whilst providing an air gap to keep cooler

100% Airbag Deploy Safe - Employs the use of a special thread and controlled stitching process to ensure compliance.

Built-in - Map pockets and lumbar support control access.

## WINCHES

Australian engineer, designed and tested.

Designed to suit all Ironman 4x4 Bull Bars as well as most winch compatible bull bars on the market.

9,500lb or 12,000lb options, available with synthetic rope or steel cable.

High speed balanced motor with sealed bearings and fully sealed style solenoid. Repositionable clutch handle. IP68 rated with external remote breather. Integrated anti-tamper power cut off and an all in one wireless/plug in controller with LED torch.



## LED LIGHTS

Available in a range of Driving Light or Light Bar styles to suit most end user requirements.

See page 23-26 for different styles, or page 434-435 for technical specifications and product comparison.



## DC TO DC BATTERY CHARGERS

Made in Australia, the 40 amp DC to DC charger is suitable for 12 volt vehicle and trailer systems. The DC to DC unit also works with standard or variable/smart alternators. 3-stage 12V booster charger. Remote charge status LED indicator. Very low standby current <3mA.



Optional start assist kit, assists to start the car when the main battery is flat and also can boost charge amperage output to 80Amp max.

## ELECTRIC BRAKE CONTROLLER

Easily adjust the strength of the brakes on your trailer when towing.

Easy adjustment dashboard dial. Remote hideaway control box. Mountable at any angle. Push button override function. Dual axle capability.

Compatible with ESC, single and dual axle trailers

Alko Approved unit.



## REAR TOW BARS

Australian Designed and developed to suit 4x4 vehicles with factory bumpers.

Dynamic and static testing to 3500kg. Comes complete with tow hitch, pin and 3500kg rated 50mm tow ball.



## REAR PROTECTION TOW BARS

Designed for complete vehicle rear protection.

Meets ADR and Australian towing standards. Side rear quarter protection. 4mm steel construction with 8mm tow bar sub frame. Protected location for anderson and trailer plug. LED numberplate lights. Dynamic and static testing to 3500kg. Comes complete with tow hitch, pin and 3500kg rated 50mm tow ball.



## ABS CANOPIES

Heavy duty 9mm smooth finish ABS Plastic construction with an in-built metal supporting frame.

Marine carpet lined. Colour coded options or can be matched to suit vehicle colour. Rear LED stop light on some models. Plug and play wiring loom. Internal clamps. Internal light and front sliding window. Lockable tinted lift up windows with gas struts. Central locking available for some models.





# Features and Benefits

## PINNACLE CANOPIES

Heavy duty smooth finish vinyl ester fiberglass construction with a reinforced structural frame.



Colour coded options or can be matched to suit vehicle colour. Roof rails. Internal battery operated light. Internal front sliding window. Lockable tinted lift up windows with gas struts. Central locking.

## SINGLE AND TWIN DRAWER SYSTEMS

Available as a single or double drawer option. Wing kits available to suit twin drawer systems.



Comes fully assembled. 100kg rating per drawer. Galvanised steel construction lined with marine grade carpet. T-Lock lockable handles.

## LONG RANGE FUEL TANKS

Designs to suit a wide range of models, with capacities of up to 160L.



2mm aluminised steel with a black powdercoat finish. 5 day pressure tested. Internal baffles.

## ICE CUBE FRIDGE / FREEZERS

SECOP Compressor. Electronically controlled. Low energy consumption. 3 year components warranty. 5 year compressor warranty. Fridge or freezer functionality (65L has both).



## ROOFTOP TENTS

### Soft Rooftop Tent

Premium 280gsm Ripstop poly cotton canvas. Insect mesh, internal covers and heavy duty 1000D waterproof cover.



Add on Annex options are available for this model (sold separately).

### Swift 1400 Rooftop Tent

Premium 280gsm Ripstop poly cotton canvas. Insect mesh, internal covers, 80mm high density foam mattress, roof rails and all enclosed in a heavy duty aluminium hard top and base.

### Nomad 1300 Rooftop Tent

Premium 280gsm Ripstop poly cotton canvas and 420D Oxford flysheet. Insect mesh, 80mm high density foam mattress and all enclosed in a heavy duty ABS top and base.

Front extension awning kit are available for this model (sold separately).

## AWNINGS

Available in a range of widths and lengths and styles. Please see page 24-26 for details and other add on options that are also available.



Premium 280gsm Ripstop UV50+ rated poly cotton canvas. Twist lock aluminium poles. Reflective guy ropes. 1000D PVC cover. Room enclosures available as an add on.

## STEEL ROOF RACKS

Available in a range of styles and sizes, please see page 38 for variations.



Strong steel construction.

Spare wheel mount on Cage and Trade style racks.

Durable black powdercoated finish. Heavy duty reinforced mesh flooring. Wind noise reducing air deflector plate.

Roof rack mounting kits also available, sold separately.

## ALLOY ROOF RACKS

Available in a range of styles and sizes, please see page 37 for variations.



Up to 60% lighter than steel roof racks.

Lightweight but strong alloy construction.

Durable gunmetal grey powdercoated finish. Heavy duty reinforced aluminium mesh flooring. Wind noise reducing air deflector plate.

Roof rack mounting kits also available, sold separately.

## UNDERBODY PROTECTION

Safeguard against off-road damage from rocks, stumps and ground strikes. Available in IUP or UBP series.



See vehicle listings to see options available for each vehicle.

### IUP Series

2.5-3mm pressed and folded steel.

Easy bolt-on installation.

Semi-gloss black powdercoated finish.

### UBP Series

4mm fabricated steel.

Recessed hardware and integrated framework.

5 x impact resistance.

Airflow ventilation channels and service inspection holes.

Textured black powdercoated finish and anti-corrosion coating.



If you can dream it, you can do it!



for a full range of accessories visit our website

[www.ironman4x4.com](http://www.ironman4x4.com)





# ***Accessories Specifications***

***Effective 1 November 2021***



# Winches and Bull Bars

## MONSTER WINCHES

Part Number	Capacity	Description	Weight
WWB9500	9500lb	With Steel Cable and Wireless Plug in Controller	N.W 42kg (90lb)
WWB12000	12000lb	With Steel Cable and Wireless Plug in Controller	N.W 44kg (98lb)
WWB9500SR	9500lb	With Synthetic Rope and Wireless Plug in Controller	N.W 28kg (62lb)
WWB12000SR	12000lb	With Synthetic Rope and Wireless Plug in Controller	N.W 29kg (64lb)

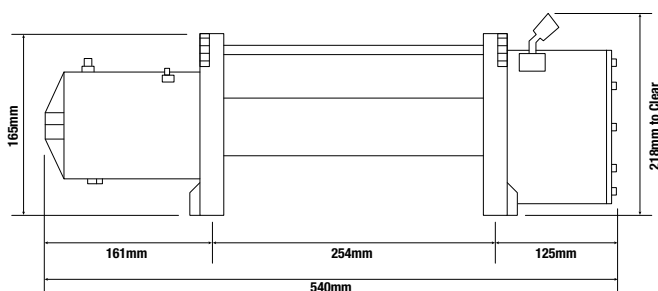

**SIDE VIEW**

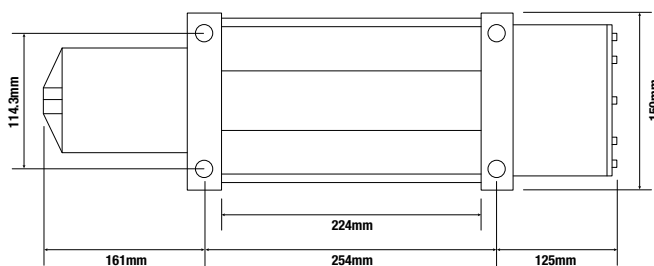

**BOLTING PATTERN**

## BULL BARS

**IMPORTANT: IRONMAN 4X4 BULL BARS CONFORM TO AUSTRALIAN STANDARDS AS47861.1/2002**

- Scanned in 3D to ensure a correct and accurate fit with a stylish, but dependable design
- Ironman 4x4 bull bars are tested for ADR, Airbag compliance and compatibility with vehicle safety systems
- Made from the highest quality of SPHC oil and pickled steel (not mild steel) for maximum strength and highest resistance to rust
- Ironman 4x4 bull bars are CNC laser cut, bent and robot welded for optimum accuracy and finish
- Ironman 4x4 designed and engineered to ensure Airbag compatibility
- Winch compatible and use a unique mounting cradle to remove excess weight from the bull bar
- Black powdercoating using AKZO NOBEL powder (YN100G) allows a thicker, smoother and more durable coating
- Ironman 4x4 designed aerial mount for quick installation and removal of an aerial
- Integrated spot light or light bar mounts



**360° ROBOT WELDS**



**FOG LIGHTS**



**LED PARKER / INDICATOR LIGHTS**



**SPOT OR LIGHT BAR MOUNTS**



**AERIAL MOUNT**

### COMMERCIAL

- ADR 69, 73 compliant
- Air bag tested and certified
- Winch compatible
- Aerial mount

### BBC

- Steel construction
- A-Frame triple loop design
- Tough polyurethane bumpers
- LED parker / indicator included





# Bull Bars

## COMMERCIAL DELUXE

### BBCD

- ADR 69, 73 compliant
- Air bag tested and certified
- Winch compatible
- Aerial mount
- Steel construction
- A-Frame triple loop design
- Tough polyurethane bumpers
- Fog lights (55W H3)
- LED parker / indicator included



## PROTECTOR

### BBT

- ADR 69, 73 compliant
- Air bag tested and certified
- Winch compatible
- Aerial mount
- Steel construction
- Stainless steel triple loop design
- Tough polyurethane bumpers
- Fog lights (55W H3)
- LED parker / indicator included



## POLISHED ALLOY

### BBA

- ADR 69, 73 compliant
- Air bag tested and certified
- Winch compatible
- Aerial mount
- 5mm aluminium frame
- 5mm sub frame
- 35% lighter than steel
- A-Frame triple loop design
- Tough polyurethane bumpers
- LED parker / indicator included



## PREMIUM COMMERCIAL DELUXE

### BBP

- ADR 69, 73 compliant
- Air bag tested and certified
- 60.3mm steel tube construction
- Winch compatible
- Aerial mount
- A-Frame triple loop design
- Tough polyurethane bumpers
- Fog lights (55W H3)
- LED parker / indicator included



## PROGUARD NO LOOP

### BBT

- ADR 69, 73 compliant
- Air bag tested and certified
- Winch compatible
- Steel construction
- Tough polyurethane bumpers
- Fog lights (55W H3)
- LED parker / indicator included
- Single or triple loop options available



## RAID SERIES

### BBR

- ADR 69, 73 compliant
- Air bag tested and certified
- Winch compatible
- Steel construction
- Integrated recovery points
- Cube lights and lightbars shown are available as additional options



# Panel Protection and Recovery

Bull Bars, Rear Tow Bars, Side Steps / Rails and Recovery Points

TO SUIT VEHICLE MAKE AND MODEL	Commercial	Commercial Deluxe	Protector	Polished Alloy	Proguard No Loop <sup>3</sup>	Premium / Special	Recovery Points	Tow Bars	Rear Step Tow Bars	Side Steps and Rails	Side Steps	Side Rails	Page
Approximate Weight	86kg	86 kg	82kg	62kg	75kg	92kg	-	30kg	69kg	53kg	40kg	13kg	
Tube Diameter	51mm	51mm	51mm	51mm	-	60.3mm	-	-	-	51/60.3mm	51/60.3mm	51/60.3mm	
To Suit Fiat Fullback 2016+	BBC050	BBCD050		BBA050	BBT050-NL		IRP050	TB050	RTB050	SSR050	SS050	SS050 RAIL	45
To Suit Ford Maverick 1988-1994 (See Nissan GQ Patrol)		BBCD010											228
To Suit Ford Ranger Raptor 2018+									RTB069				50
To Suit Ford Ranger PX Mk III 8/2018+ WITH or WITHOUT Tech Pack Adaptive Cruise Control (CC)		BBCD066*			BBT066-NL*		IRP054	TB066	RTB066	SSR054	SS054	SS054 RAIL	52
To Suit Ford Ranger PX Mk III 8/2018+ WITHOUT Tech Pack Adaptive CC With Sensor Provisions	BBC055	BBCD055					IRP054	TB066	RTB066	SSR054	SS054	SS054 RAIL	52
To Suit Ford Ranger PX Mk II 2015-7/2018 WITH or WITHOUT Tech Pack Adaptive Cruise Control (CC)		BBCD054			BBT054-NL		IRP054	TB066	RTB066	SSR054	SS054	SS054 RAIL	56
To Suit Ford Ranger PX Mk II 2015-7/2018 WITHOUT Tech Pack Adaptive CC With Sensor Provisions	BBC055	BBCD055					IRP054	TB066	RTB066	SSR054	SS054	SS054 RAIL	56
To Suit Ford Ranger PX 9/2011-2015	BBC038	BBCD038			BBT038-NL		IRP054	TB066	RTB066	SSR054	SS054	SS054 RAIL	60
To Suit Ford Ranger PJ / PK 2007+ <sup>2</sup>		BBCD014	BBT014							SSR002	SS008		64
To Suit Ford Everest AU II 7/2018+ WITH or WITHOUT Tech Pack Adaptive Cruise Control (CC)		BBCD066*			BBT066-NL*		IRP054			SSR055	SS055	SS055 RAIL	67
To Suit Ford Everest AU II 7/2018+ WITHOUT Tech Pack Adaptive CC With Sensor Provisions	BBC055	BBCD055					IRP054			SSR055	SS055	SS055 RAIL	67
To Suit Ford Everest 2015-6/2018 WITH or WITHOUT Tech Pack Adaptive Cruise Control (CC)		BBCD054			BBT054-NL		IRP054			SSR055	SS055	SS055 RAIL	69
To Suit Ford Everest 2015-6/2018 WITHOUT Tech Pack Adaptive CC With Sensor Provisions	BBC055	BBCD055					IRP054			SSR055	SS055	SS055 RAIL	69
To Suit GM/Holden Trailblazer LT / LTZ 11/2017+	BBC057	BBCD057			BBT057-NL		IRP057 IRP058			SSR044	SS044	SS044 RAIL	76
To Suit GM/Holden Colorado RG 11/2016-2020	BBC057	BBCD057			BBT057-NL		IRP057 IRP058	TB040	RTB040	SSR057	SS057	SS057 RAIL	80
To Suit GM/Holden Colorado RG 2012-10/2016	BBC040	BBCD040					IRP058	TB040	RTB040	SSR057	SS057	SS057 RAIL	85
To Suit GM/Holden Colorado 7 RG 2012+		BBCD044					IRP058			SSR044	SS044	SS044 RAIL	78
To Suit GM/Holden Colorado RC 7/2008-12/2012 <sup>1,2</sup>		BBCD027	BBT027							SSR006	SS001		87
To Suit GM/Holden Rodeo RA7 2007-7/2008		BBCD020								SSR006	SS001		89
To Suit GM/Holden Rodeo RA 2002-2006 <sup>2</sup>		BBCD003								SSR006	SS001		91
To Suit Isuzu D-MAX 8/2019+		BBCD074			BBT074-NL		IRP074		RTB074	SSR074	SS074	SS074 RAIL	98
To Suit Isuzu D-MAX 2/2017-7/2019 (Will not fit narrow body)	BBC058	BBCD058	BBT058		BBT058-NL		IRP058	TB041	RTB041	SSR057	SS057	SS057 RAIL	101
To Suit Isuzu D-MAX 6/2012-1/2017	BBC041	BBCD041	BBT041				IRP058	TB041	RTB041	SSR057	SS057	SS057 RAIL	104
To Suit Isuzu D-MAX 2007-6/2012 <sup>2</sup>		BBCD020								SSR006	SS001		108
To Suit Isuzu MU-X 3/2017+		BBCD061			BBT061-NL		IRP058			SSR044	SS044	SS044 RAIL	110
To Suit Isuzu MU-X 2014-2/2017		BBCD049	BBT049				IRP058			SSR044	SS044	SS044 RAIL	110
To Suit Jeep Gladiator JT 4/2019+	BBR077 - (Raid Full Length Bumper)			BBR077ST <sup>4</sup> - (Raid Stubby Bumper)					RTB077JT		SS077JT		118
To Suit Jeep Grand Cherokee WK2 2013+ <sup>5</sup>		BBCD052											120
To Suit Jeep Wrangler JL (4 Door) 2018+	BBR077 - (Raid Full Length Bumper)			BBR077ST <sup>4</sup> - (Raid Stubby Bumper)				TB077JL	RTB077JL		SS077JL		124
To Suit Jeep Wrangler JK 2007+	BBR077	BBCD035		BBR077ST <sup>4</sup>									126
To Suit Land Rover Defender 2007-2016	BBC023												133
To Suit LDV T60 2017+		BBCD068*			BBT068-NL*								142
To Suit Mazda BT50 6/2020		BBCD080			BBT080-NL				RTB080	SSR074	SS074	SS074 RAIL	147
To Suit Mazda BT50 2012-5/2020 <sup>2</sup>	BBC039	BBCD039			BBT039-NL		IRP054	TB066	RTB066	SSR039	SS039		150
To Suit Mazda BT50 J97M 2006-2011 <sup>1,2</sup>		BBCD024	BBT024							SSR007	SS009		154
To Suit Mitsubishi Pajero Sport 7/2019+		BBCD079*			BBT079-NL*		IRP059				SS079		162
To Suit Mitsubishi Pajero Sport 11/2016-6/2019 (BBCD suits GLX +GLS only)		BBCD059*			BBT059-NL*		IRP059				SS059		164
To Suit Mitsubishi Pajero NW 2011-NX		BBCD045											166
To Suit Mitsubishi Pajero NS & NT 5/2000-2011		BBCD045											167
To Suit Mitsubishi Triton MR (GLS Model) 11/2018+		BBCD067*			BBT067-NL*		IRP059	TB050	RTB067GLS	SSR050	SS050	SS050 RAIL	178
To Suit Mitsubishi Triton MR (Non-GLS Model) 11/2018+		BBCD067*			BBT067-NL*		IRP059	TB050	RTB067GLX	SSR050	SS050	SS050 RAIL	178
To Suit Mitsubishi Triton MQ 2015-10/2018	BBC050	BBCD050		BBA050	BBT050-NL		IRP050	TB050	RTB050	SSR050	SS050	SS050 RAIL	182
To Suit Mitsubishi Triton MN 2009-2015 <sup>1,2</sup>	BBC031	BBCD031	BBT031							SSR031	SS031		187
To Suit Mitsubishi Triton ML 2006-2009 <sup>1,2</sup>		BBCD016	BBT016							SSR031			190
To Suit Nissan Navara NP300 2021 (Series 5)		BBCD082				BBP082	IRP082		RTB082	SSR082 / SSRP082	SS082 / SSP082	SS082 RAIL / SSP082 RAIL	197
To Suit Nissan Navara NP300 2015-2020 (Series 1-4)	BBC048	BBCD048		BBA048	BBT048-NL		IRP005	TB048	RTB048	SSR048	SS048	SS048 RAIL	200
To Suit Nissan Navara D40 <sup>2</sup> (Does not suit 2010+ STX - Spain Build)		BBCD012	BBT012				IRP005			SSR003	SS007		203
To Suit Nissan Navara D40 V6 2010+ STX <sup>2</sup>		BBCD042					IRP005			SSR042	SS042		203



# Panel Protection and Recovery

TO SUIT VEHICLE MAKE AND MODEL	Commercial	Commercial Deluxe	Protector	Polished Alloy	Proguard No Loop <sup>3</sup>	Premium / Special	Recovery Points	Tow Bars	Rear Step Tow Bars	Side Steps and Rails	Side Steps	Side Rails	Page
Approximate Weight	86kg	86 kg	82kg	62kg	75kg	92kg	-	30kg	69kg	53kg	40kg	13kg	
Tube Diameter	51mm	51mm	51mm	51mm	-	60.3mm	-	-	-	51/60.3mm	51/60.3mm	51/60.3mm	
To Suit Nissan Navara D22 2002+ <sup>1 2</sup>		BBCD013	BBT013										206
To Suit Pathfinder R51 2005-2013		BBCD012	BBT012										210
To Suit Nissan Pathfinder R51 2010+		BBCD042											210
To Suit Nissan Patrol Y62 2010-2019						BBP062							216
To Suit Nissan Patrol Y61 GU Series 4 2005+ <sup>1</sup>						BBP011	IRP005			SSR012 / SSRP011	SS012		218
To Suit Nissan Patrol Y61 GU Series 1-3 1998-2004 <sup>1</sup> (Coil Spring Only)		BBCD009					IRP005			SSR012	SS012		219
To Suit Nissan Patrol Y60 GQ 1987-1997 <sup>1</sup> (Coil Spring Only)		BBCD010											228
To Suit Renault Alaskan 2017+ (Thai Built Only)	BBC048	BBCD048		BBA048	BBT048-NL			TB048	RTB048	SSR048	SS048	SS048 RAIL	240
To Suit SsangYong Musso Q200 / 201 / 205 / 215 10/2018+		BBCD071*											243
To Suit SsangYong Rexton Y400 10/2018+		BBCD071*											248
To Suit Suzuki Jimny GJ 2019+		BBCD070*				BBS070*	IRP070						254
To Suit Suzuki Jimny 2012-2018		BBCD063*											256
To Suit Suzuki Grand Vitara 2012+ <sup>6</sup> (Diesel Manual Only)		BBCD046	BBT046										260
To Suit Toyota 4Runner Gen 5 N280 2009+	BBR078 <sup>4</sup> - (Raid Stubby Bumper)								RTB078		SS078		264
To Suit Toyota FJ Cruiser 2006+		BBCD037											270
To Suit Toyota Fortuner 2020+ (facelift)		BBCD081			BBT081-NL		IRP051			SSR053	SS053	SS053 RAIL	272
To Suit Toyota Fortuner 2015-9/2020		BBCD053	BBT053		BBT053-NL		IRP051			SSR053	SS053	SS053 RAIL	272
To Suit Toyota Fortuner 2004-2015	BBC030	BBCD030	BBT030		BBT030-NL								274
To Suit Toyota Hilux 8/2020+		BBCD076 BBCD076-NB <sup>7</sup>			BBT076-NL		IRP051	TB051	RTB051-SP	SSR051	SS051	SS051 RAIL	278
To Suit Toyota Hilux Revo 5/2018-7/2020	BBC065 BBC065-NB <sup>7</sup>	BBCD065		BBA065	BBT065-NL		IRP051	TB051	RTB051-P	SSR051	SS051	SS051 RAIL	282
To Suit Toyota Hilux Revo 2015-4/2018	BBC051	BBCD051		BBA051	BBT051-NL		IRP051	TB051	RTB051-P	SSR051	SS051	SS051 RAIL	282
To Suit Toyota Hilux Vigo 10/2011-2015 <sup>1</sup>	BBC033	BBCD033	BBT033				IRP033			SSR033	SS033		286
To Suit Toyota Hilux Vigo 3/2005-9/2011 <sup>1</sup>	BBC002	BBCD002					IRP033			SSR033	SS033		286
To Suit Toyota Hilux Tiger 1997-2004 IFS <sup>1</sup>		BBCD001											290
To Suit Toyota Landcruiser 200 Series 11/2015+	BBC056* <sup>7</sup>			BBA056-VX*	BBT-056VX-NL*	BBP056-VX*	IRP056			SSRP056	SSP056	SSP056 RAIL	295
To Suit Toyota Landcruiser 200 Series / Lexus LX570 11/2007-1/2012						BBP025	IRP056						298
To Suit Toyota Landcruiser 200 Series / Lexus LX 570 2/2012-10/2015	BBC043					BBP043	IRP056						298
To Suit Toyota Landcruiser 105 Series 3/1998-10/2007		BBCD005					IRP005						300
To Suit Toyota Landcruiser 100 Series IFS / Lexus LX470 3/1998-10/2007		BBCD006					IRP005						303
To Suit Toyota Landcruiser 80 Series / Lexus LX 450 1990-1998		BBCD004					IRP005						305
To Suit Toyota Landcruiser 79 Series Single Cab 9/2016+ <sup>1</sup>	BBC019SC		BBT019SC			BBP019SC	IRP019SC			SSR019SC / SSRP019SC	SS019SC / SSP019SC	SS019SC RAIL / SSP019SC RAIL	308
To Suit Toyota Landcruiser 79 Series Single Cab 2007-8/2016 <sup>1</sup>	BBC019E					BBP019E	IRP019			SSR016 / SSRP016	SS016	SSR016	308
To Suit Toyota Landcruiser 79 Series Single Cab 1999-2007 <sup>1</sup>	BBC018	BBCD018											308
To Suit Toyota Landcruiser 79 Series Dual Cab 11/2012+ <sup>1</sup>	BBC019E					BBP019E	IRP019			SSR019 / SSRP019	SS019		311
To Suit Toyota Landcruiser 78 Series Troop Carrier 2007+ <sup>1</sup>	BBC019E					BBP019E	IRP019						315
To Suit Toyota Landcruiser 78 Series Troop Carrier 1999-2007+ <sup>1</sup>	BBC018	BBCD018											319
To Suit Toyota Landcruiser 76 Series 2007+ <sup>1</sup>	BBC019E					BBP019E	IRP019			SSR015 / SSRP015	SS015		323
To Suit Toyota Landcruiser 75, 78, 79 Series 1984-2007	BBC018	BBCD018											308, 319, 322
To Suit Toyota Prado 150 Series Facelift 11/2017+					BBT064-NL*	BBP064*	IRP064			SSRP064	SSP064	SSP064 RAIL	340
To Suit Toyota Prado 150 Series 10/2013-10/2017	BBC047	BBCD047					IRP064			SSR047	SS047		343
To Suit Toyota Prado 150 Series 11/2009-10/2013		BBCD029 <sup>8</sup>					IRP064			SSR047	SS047		343
To Suit Toyota Prado 120 Series 4/2003-10/2009 <sup>1</sup>		BBCD008								SSR004	SS017		346
To Suit Toyota Prado 90, 95 Series 1996-10/2002 <sup>1</sup>		BBCD007											348
To Suit Toyota Tacoma 2005+						BBR072			RTB072		SS072		350
To Suit Toyota Tundra 2013-2020						BBR073			RTB073		SS073		352
To Suit Volkswagen Amarok V6 / 4 Cyl 11/2016+		BBCD060			BBT060-NL				RTB060	SSR034	SS034	SS034 RAIL	358
To Suit Volkswagen Amarok 2011-10/2016		BBCD034	BBT034							SSR034	SS034	SS034 RAIL	360

NOTES: \* Only compatible with Synthetic Rope Winch and Alloy Hawse. <sup>1</sup> Suits narrow body model. <sup>1</sup> Suits flared guard model. <sup>2</sup> Suits both 2WD and 4WD models. <sup>3</sup> Single and triple loop options available. <sup>4</sup> Not available in Australia. <sup>5</sup> Not suitable for vehicles with forward facing radar. <sup>6</sup> Not compatible with V6 model. <sup>7</sup> Suits GX model only. <sup>8</sup> Not compatible with sensors and headlight washers.





# Snorkels

## SNORKELS

Vehicle Make	Model and Specifics	3" Hat	3.5" Hat	4" Hat	Part Number	Page
To Suit Fiat Fullback	2016+			•	ISNORKELO50	45
To Suit Ford Maverick	1988-1994 - (All models except 2.8L Diesel)	•			ISNORKELO11	228
To Suit Ford Ranger	PX III XL 8/2018+ 3.2L Diesel (with side indicator)		•		ISNORKELO34	52
To Suit Ford Ranger	PX III XLT 8/2018+ 3.2L Diesel (with indicator on side mirror)		•		ISNORKELO34XLT	52
To Suit Ford Ranger	PX / PX II XL 7/2011+ 2.2 and 3.2L Diesel		•		ISNORKELO34	56, 60
To Suit Ford Ranger	PX / PX II XLT 7/2011+ 2.2 and 3.2L Diesel		•		ISNORKELO34XLT	56, 60
To Suit Ford Ranger	PJ / PK 2006-2011+ - 3.0L TDI Diesel		•		ISNORKELO21	64
To Suit GM / Holden Trailblazer	LT LTZ 2017+		•		ISNORKELO36	76
To Suit GM / Holden Colorado / Colorado 7	RG 2012-2020		•		ISNORKELO36	80, 85, 78
To Suit GM / Holden Colorado	RC 2008-2012		•		ISNORKELO28	87
To Suit GM / Holden Rodeo	RA7 LX and LT 2007-7/2008 - (Does not fit DX Model)		•		ISNORKELO22	89
To Suit Isuzu D-Max	8/2019+		•		ISNORKELO74	98
To Suit Isuzu D-Max	6/2012 to 7/2019		•		ISNORKELO41	101, 104
To Suit Isuzu D-Max	2009-2012 - (Does not fit 4x2 SX Model)		•		ISNORKELO22	108
To Suit Isuzu MU-X	2014+		•		ISNORKELO41	110
To Suit Jeep Wrangler	JK 2007+ (Not available in Australia)	•			ISNORKELO32	126
To Suit Mazda BT50	6/2020+		•		ISNORKELO80	147
To Suit Mazda BT50	11/2006-2012 - 3.0L TDI Diesel		•		ISNORKELO24	154
To Suit Mitsubishi Triton	MR 11/2018+		•		ISNORKELO67	178
To Suit Mitsubishi Triton	MQ 2015-10/2018 - 2.4L Diesel			•	ISNORKELO50	182
To Suit Mitsubishi Triton	ML / MN 2006-2015		•		ISNORKELO20	187, 190
To Suit Nissan Navara	NP300 2015-2020 - Suits Wide and Narrow Body 2.3L Twin and Single Turbo Diesel			•	ISNORKELO48	200
To Suit Nissan Navara	D40 2005+ (Does not suit 2010+ STX - Spain Build Single Cab)		•		ISNORKELO19	203
To Suit Nissan Pathfinder	R51 2005-2013		•		ISNORKELO19	210
To Suit Nissan Patrol	GU Series 4 2005+		•		ISNORKELO13	218
To Suit Nissan Patrol	GU Series 1, 2 and 3 1998-2004	•			ISNORKELO15	219
To Suit Nissan Patrol	GQ 1987-1997 - (All models except 2.8L Diesel)	•			ISNORKELO11	228
To Suit Suzuki Jimny	GJ 2018+		•		ISNORKELO70	254
To Suit Toyota Fortuner	2015+			•	ISNORKELO53	272
To Suit Toyota Hilux	8/2020+ 2.8L Turbo Diesel			•	ISNORKELO51	278
To Suit Toyota Hilux	8/2020+ Narrow Body Model		•		ISNORKELO76N	278
To Suit Toyota Hilux	Revo 2015-7/2020 - 2.8L Turbo Diesel			•	ISNORKELO51	282
To Suit Toyota Hilux	Vigo 2005-2015 - 3.0L TDi, 4.0L Petrol V6		•		ISNORKELO01	286
To Suit Toyota Landcruiser	200 Series 11/2015+		•		ISNORKELO56	295
To Suit Toyota Landcruiser	200 Series 11/2007-10/2015		•		ISNORKELO10	298
To Suit Toyota Landcruiser / Lexus	105 and 100 Series / LX 470 1998-2007		•		ISNORKELO03	300, 303
To Suit Toyota Landcruiser / Lexus	80 Series / LX 450 1990-1998		•		ISNORKELO04	293
To Suit Toyota Landcruiser	79 / 78 / 76 Series 2007+		•		ISNORKELO23	308, 311, 315, 323
To Suit Toyota Landcruiser	75, 78, 79 Series 1984-2007		•		ISNORKELO09	304, 319, 326
To Suit Toyota Prado	150 Series 11/2017+ 2.8L		•		ISNORKELO64	340
To Suit Toyota Prado	150 Series 11/2009-10/2017 3L D4D TDi / 4L Petrol V6 and 2.8L D4D TDi		•		ISNORKELO35	343
To Suit Toyota Prado	120 Series 2003-2009 3L D4D TDi / 4L Petrol V6		•		ISNORKELO06	346
To Suit Toyota Prado	90 / 95 Series 1996-2002 3.4L Petrol V6	•			ISNORKELO05	348
To Suit Volkswagen Amarok	2011+			•	ISNORKELO37	358, 360

REFER TO VEHICLE LISTING PAGES FOR SPECIFIC MODEL COMPATIBILITY / SUITABILITY

## Underbody Protection

## UNDERBODY PROTECTION

Vehicle Make	Model and Specifics	Standard Part No.	Premium Part No.	Page
To Suit Fiat Fullback	2016+	IUP050K	UBP050	45
To Suit Ford Ranger	PX III 8/2018+		UBP055	52
To Suit Ford Ranger	PX II 2015-7/2018	IUP014K / IUP014F	UBP054 / UBPO55	56
To Suit Ford Ranger	PX 7/2011-2015	IUP014K / IUP014F	UBP054	60
To Suit Ford Ranger	PJ / PK 2006-2011	IUP008K		64
To Suit Ford Everest	UA II 7/2018+		UBP055	67
To Suit Ford Everest	9/2015-6/2018	IUP014K	UBP054	69
To Suit GM / Holden Colorado / Trailblazer	RG 11/2016-2020 / Trailblazer LT / LTZ 2017+		UBP057	76, 80
To Suit GM / Holden Colorado	RG 2012-10/2016 / Colorado 7 RG 2012-2016		UBP041	78, 85
To Suit GM / Holden Colorado	RC 2008-2012	IUP009K		87
To Suit GM / Holden Rodeo	RA and RA7 2002-2008	IUP009K		89, 91
To Suit Isuzu D-Max	8/2019+		UBP074 / UBPO74S	98
To Suit Isuzu D-Max / MU-X	6/2012 to 7/2019 / MU-X 2014+		UBP041	101, 104, 110
To Suit Isuzu D-Max	2007-06/2012	IUP009K		108
To Suit Landrover Discovery	Series 3, 4 and Range Rover Sport 2005 to 2013	IUP016K		138
To Suit Mazda BT50	6/2020+		UBP074 / UBPO74S	147
To Suit Mazda BT50	2012-5/2020	IUP014K / IUP014F	UBP054 / UBPO55	150
To Suit Mazda BT50	2006-2011	IUP008K		154
To Suit Mitsubishi Pajero Sport	7/2019+		UBP050	162
To Suit Mitsubishi Pajero	2000-2011	IUP013K		166, 167
To Suit Mitsubishi Triton	MR and MQ 2015+	IUP050K	UBP050	178, 182
To Suit Mitsubishi Triton	ML 2006-2009	IUP010K / IUP010F		190
To Suit Nissan Navara	NP300 2015-2020 (Series 1 / Series 2, 3 & 4)		UBP048 / UBPO48S	200
To Suit Nissan Navara	D40 2005+ (Diesel only)	IUP007K / IUP007F		203
To Suit Nissan Navara	D22 2002+ (Diesel only)	IUP006K		206
To Suit Nissan Pathfinder	R51 2005+	IUP007E		210
To Suit Nissan Patrol	GU Series 1, 2, 3 and 4 1998+ (3.0L and 4.8L only)	IUP015K		218, 219
To Suit Renault Alaskan	2017+ (Series 1 / Series 2, 3 & 4)		UBP048 / UBPO48S	240
To Suit SsangYong Musso / Rexton	Q200, Q201, Q205 and Q215 / Y400 10/2018+		UBP201SY	243, 248
To Suit Suzuki Jimny	GJ 2018+		UBP070	254
To Suit Suzuki Grand Vitara	Diesel Manual 8/2005-2015	IUP011K		260
To Suit Toyota 4Runner	Gen 5, N280 2009+		UBP047	264
To Suit Toyota FJ Cruiser	2006+	IUP003K	UBP047	270
To Suit Toyota Fortuner / Hilux	2015+		UBP051	272, 278, 282
To Suit Toyota Hilux	Vigo 2005-2015	IUP001K	UBP033	286
To Suit Toyota Landcruiser	200 Series 2015+		UBP056	295
To Suit Toyota Landcruiser	200 Series 11/2007-10/2015	IUP004K / IUP004F		298
To Suit Toyota Landcruiser	79 Series S/C 2007-8/2016 / 79 Series D/C 11/2012+ / 78/76 Series 2007+		UBP019 / UBPO19SC	308, 311, 315, 323
To Suit Toyota Prado	150 Series 11/2009+	IUP003K / IUP003F	UBP047	340, 343
To Suit Toyota Prado	120 Series 2003-2009	IUP002K		346
To Suit Toyota Tacoma	2005+		UBP072	350
To Suit Toyota Tundra	2013-2020		UBP073	352
To Suit Volkswagen Amarok	2011-10/2016	IUP012K		360

REFER TO VEHICLE LISTING PAGES FOR SPECIFIC MODEL COMPATIBILITY / SUITABILITY

# Roof Racks, Mount Kits and Roof Rail Extrusions

## ROOF RACKS

Part Number	Type	Description	Weight	Dimensions (mm)		
STEEL			KG	L	W	H
IRRCAGE14	Cage Style	Steel Roof Rack	37kg	1400	1250	150
IRRCAGE18	Cage Style	Steel Roof Rack	46kg	1800	1250	150
IRRCAGE22	Cage Style	Steel Roof Rack	52kg	2200	1250	150
IRRTENT18	Rooftop Tent Compatible	Steel Roof Rack	37kg	1800	1250	150
IRRTENT22	Rooftop Tent Compatible	Steel Roof Rack	45kg	2200	1250	150
IRRTRADE18	Trade Style	Steel Roof Rack - Open End	42kg	1800	1250	150
IRRTRADE22	Trade Style	Steel Roof Rack - Open End	49kg	2200	1250	150
ALLOY			KG	L	W	H
IRRCAGE14-ALLOY	Cage Style	Alloy Roof Rack - Mesh Floor	17kg	1400	1250	150
IRRCAGE18-ALLOY	Cage Style	Alloy Roof Rack - Mesh Floor	22kg	1800	1250	150
IRRCAGE22-ALLOY	Cage Style	Alloy Roof Rack - Mesh Floor	27kg	2200	1250	150
IRROPEN14-ALLOY	Trade Style	Alloy Roof Rack - Mesh Floor, Open End	16kg	1400	1250	150
IRRTRADE18-ALLOY	Trade Style	Alloy Roof Rack - Mesh Floor, Open End	20kg	1800	1250	150
IRRTRADE22-ALLOY	Trade Style	Alloy Roof Rack - Mesh Floor, Open End	25kg	2200	1250	150
IRRTFLAT18-ALLOY	Flat Style	Alloy Roof Rack - Mesh Floor	18kg	1800	1250	30

## MOUNTING KITS

Part Number	Feet	Description	Height
IRRFEE100	8	100mm Gutter Mount	100
IRRFEE125	8	125mm Gutter Mount	125
IRRFEE150	8	150mm Gutter Mount	150
IRRFEE210	8	210mm Gutter Mount	210
IRRFEE1LC100	8	To Suit Landcruiser 100 / 105 Series Roof Mount	Adjustable
IRRFEE1LC200	8	To Suit Landcruiser 200 Series Roof Mount	Adjustable
IRRFEE001	6	To Suit GM / Holden Colorado 7 / Trailblazer	Fixed
IRRFEE1PRADO150	2	To Suit Toyota Prado 150	Fixed
IRRFEE1MUX	4	To Suit Isuzu MU-X - Replaces Roof Rails	Fixed
IRRFEE1ABS14	4 (2 pieces)	ABS Canopies 010 / 011 / 012 / 013 / 014 / 015 / 019 / 020	45

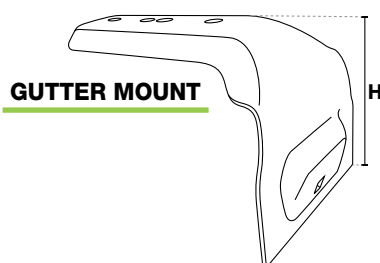
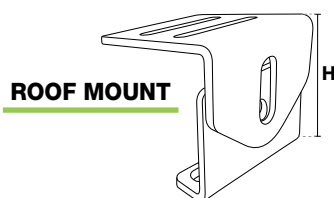

## UNIVERSAL ALLOY ROOF RAIL EXTRUSION

Part Number	Pieces	Description	Length
IRREXT1085	2	Alloy Roof Rail Extrusion	1085

REFER TO VEHICLE LISTING PAGES FOR SPECIFIC MODEL COMPATIBILITY / SUITABILITY

## Canopies

## ABS PLASTIC CANOPIES - GENERIC LISTING (WEIGHT 80KG)

Vehicle Make	Model and Specifics	Part Number	Page
To Suit Fiat Fullback	2016+	CANOPY014*	45
To Suit Ford Ranger	PX 2011-2015* / PX II 2015-7/2018 / PX III 8/2018+ / Raptor 9/2018+	CANOPY010*	50, 53, 57, 61
To Suit Ford Ranger	PJ / PK 2006 to 2011	CANOPY004*	64
To Suit GM / Holden Colorado	RG 2012 to 2020	CANOPY019*	80, 85
To Suit GM / Holden Colorado / Rodeo	RC 7/2008 to 12/2012 / RA7 2007 to 7/2008 / RA 2002 to 2006	CANOPY006	87, 89, 91
To Suit Isuzu D-Max	8/2019+	CANOPY022*	98
To Suit Isuzu D-Max	6/2012 to 7/2019	CANOPY020*	101, 104
To Suit LDV T60	2017+	CANOPY015*	142
To Suit Mazda BT50	6/2020	CANOPY022*	147
To Suit Mazda BT50	2012 to 5/2020	CANOPY010*	151
To Suit Mazda BT50	J97M 2006 to 2011	CANOPY004	154
To Suit Mitsubishi Triton	MIR 11/2018+ / MQ 2015-10/2018	CANOPY014*	179, 183
To Suit Mitsubishi Triton	MIN 2009 to 2015	CANOPY008*	187
To Suit Nissan Navara	NP300 2015 to 2020	CANOPY013*	200
To Suit Renault Alaskan	2017+	CANOPY013*	240
To Suit Toyota Hilux	2015+	CANOPY015* / CANOPY017-SW	278, 283
To Suit Toyota Hilux	J Deck 3/2005 to 2015	CANOPY002*	286
To Suit Volkswagen Amarok	2011+	CANOPY021	358, 360

\* Colour coded options available

## PINNACLE FIBREGLASS CANOPIES - GENERIC LISTING (WEIGHT 100KG)

Vehicle Make	Model and Specifics	Part Number	Page
To Suit Fiat Fullback	2016+	CANFIBRE050*	45
To Suit Ford Ranger	PX 2011-2015* / PX II 2015-7/2018 / PX III 8/2018+ / Raptor 9/2018+	CANFIBRE054*	50, 53, 57, 61
To Suit LDV T60	2017+	CANFIBRE051*	142
To Suit Mazda BT50	2012 to 5/2020	CANFIBRE054*	151
To Suit Mitsubishi Triton	MIR 11/2018+ / MQ 2015-10/2018	CANFIBRE050*	179, 183
To Suit Nissan Navara	NP300 2015 to 2020	CANFIBRE048*	200
To Suit Renault Alaskan	2017+	CANFIBRE048*	240
To Suit Toyota Hilux	2015+	CANFIBRE051*	279, 283

\* Colour coded options available

## PINNACLE 2 FIBREGLASS CANOPIES - GENERIC LISTING (WEIGHT 100KG)

Vehicle Make	Model and Specifics	Part Number	Page
To Suit Fiat Fullback	2016+	ICANOPY050*	45
To Suit Ford Ranger	PX 2011-2015* / PX II 2015-7/2018 / PX III 8/2018+ / Raptor 9/2018+	ICANOPY054*	50, 53, 57, 61
To Suit D-Max	8/2019+	ICANOPY074*	98
To Suit Mazda BT50	2012 to 5/2020	ICANOPY054*	151
To Suit Mitsubishi Triton	MIR 11/2018+ / MQ 2015-10/2018	ICANOPY050*	179, 183
To Suit Nissan Navara	2021+	ICANOPY082*	197
To Suit Nissan Navara	NP300 2015 to 2020	ICANOPY048*	200
To Suit Renault Alaskan	2017+	ICANOPY048*	240
To Suit Toyota Hilux	2015+	ICANOPY051*	279, 283
To Suit Volkswagen Amarok	2011+	ICANOPY060*	358, 360

\* Colour coded options available

REFER TO VEHICLE LISTING PAGES FOR SPECIFIC MODEL COMPATIBILITY / SUITABILITY

# LED Driving Lights

## LED DRIVING LIGHTS

### IMEGATOM

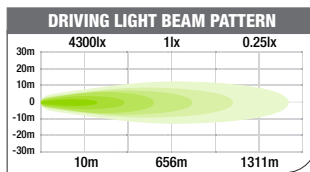
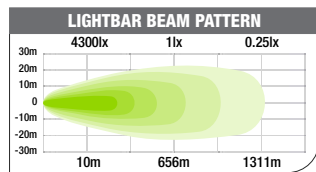
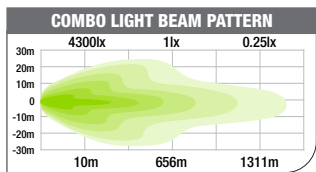
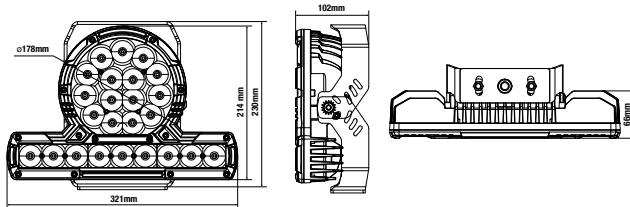

Operating Voltage: 9-30V DC

### ILED5X7

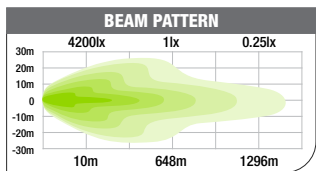
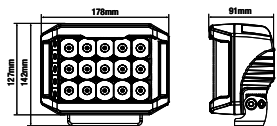

Operating Voltage: 12-24V DC

### ILEDBLAST2C

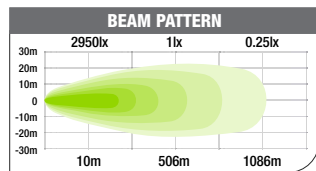
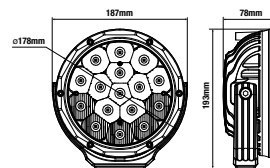

Operating Voltage: 12-24V DC

### ILEDBLAST2S

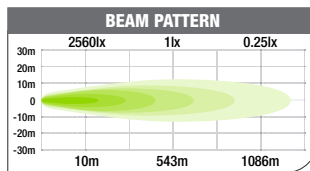
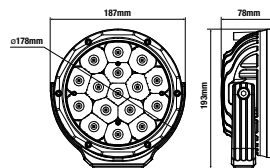

Operating Voltage: 12-24V DC

### ILED7M

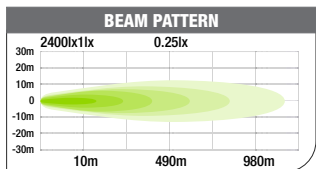
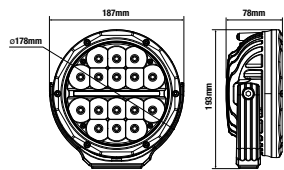

Operating Voltage: 12-24V DC

### ILED9M

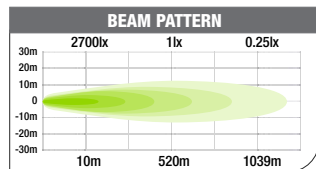
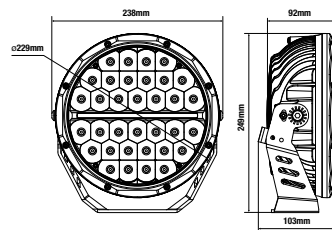

Operating Voltage: 12-24V DC

### ILED7C

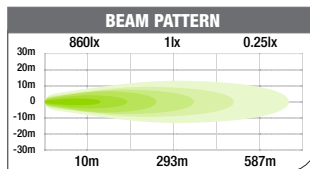
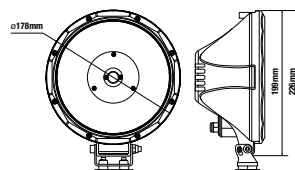

Operating Voltage: 12-24V DC

### ILED9C

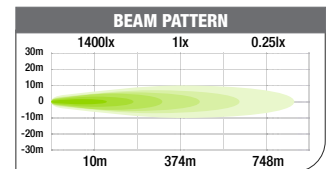
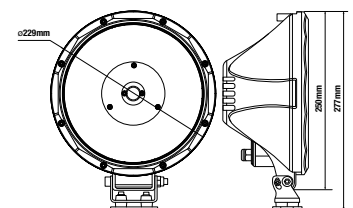

Operating Voltage: 12-24V DC

ALL LIGHTS SHOWN ARE RELATIVE SCALE TO EACH OTHER



# LED Work Lights and Upgrades

## LED WORK AND UNIVERSAL LIGHTS

Operating Voltage: 12-24V DC

**ILEDWL10 / ILEDWL10FA**

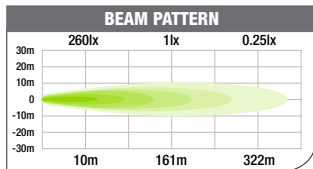
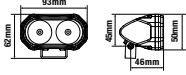

**ILEDUNI3**

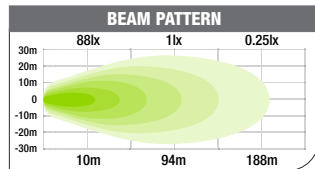
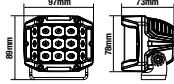

**ILEDUNI5**

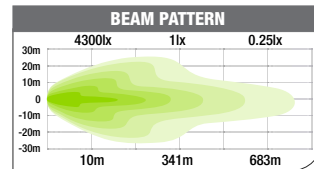
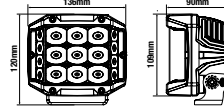

**IRL120B**

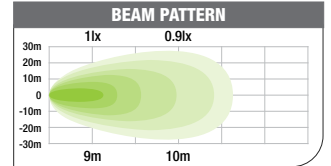
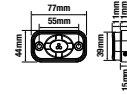

**ILED20B SERIES**

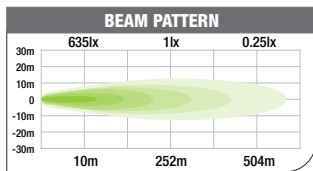
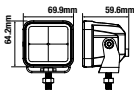

**ILED20BF SERIES**

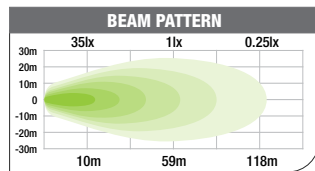
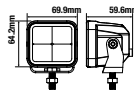

**ILED80B SERIES**

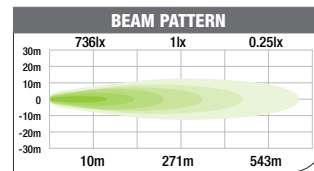
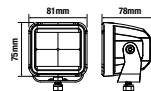

**ILED80BF SERIES**

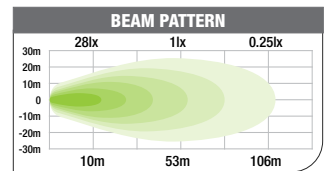
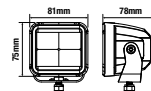

**ILEDGOSMO**

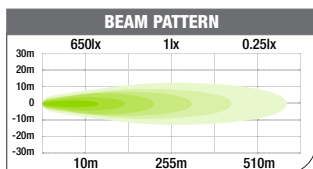
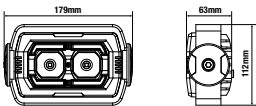

**ILED5B**

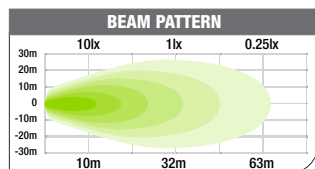
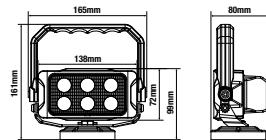

## BULL BAR UPGRADE LED LIGHTS

**BBPART031**

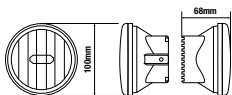

Operating Voltage: 9-32V DC

**BBPART002**

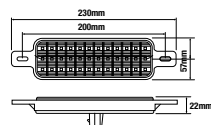

Operating Voltage: 12V DC

ALL LIGHTS SHOWN ARE RELATIVE SCALE TO EACH OTHER

# LED Lightbars

**NEW**

## SINGLE ROW - SLIM

Operating Voltage: 12-24V DC

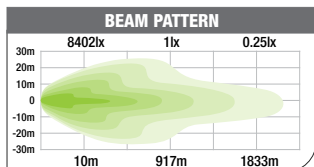
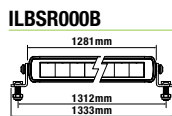
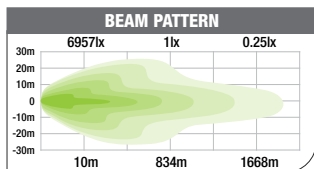
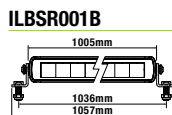
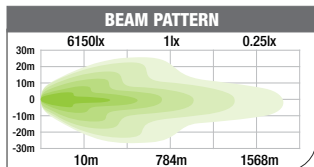
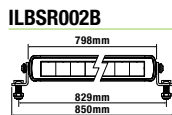
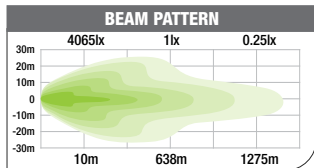
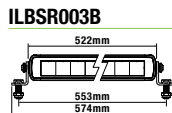
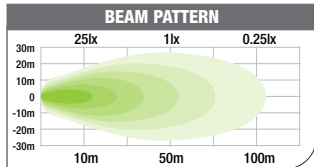
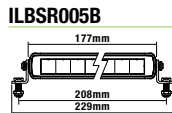
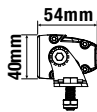

**NEW**

## SINGLE ROW - WIDE

Operating Voltage: 12-24V DC

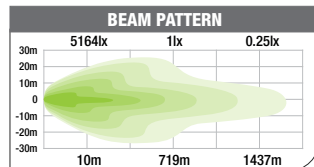
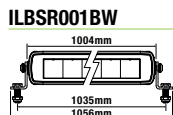
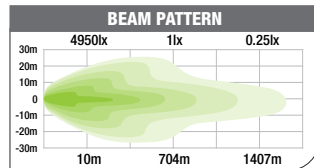
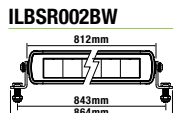
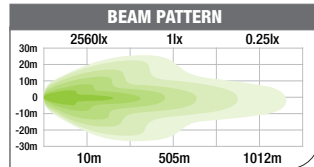
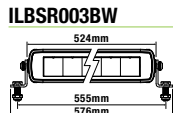
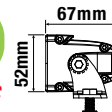

**NEW**

## DUAL ROW

Operating Voltage: 12-24V DC

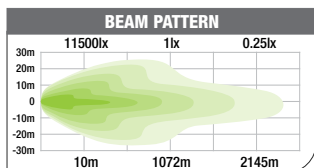
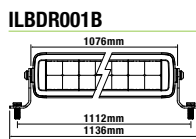
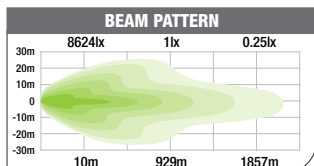
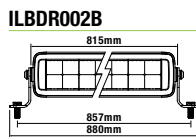
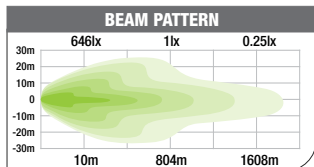
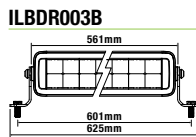
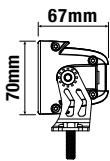

**NEW**

## DUAL ROW - MULTI FUNCTION

Operating Voltage: 12-24V DC

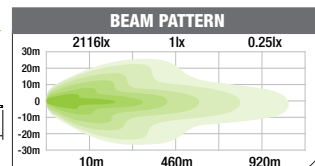
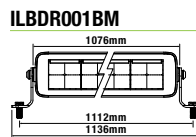
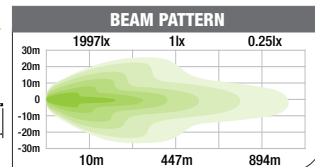
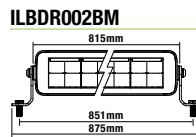
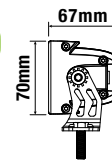

# LED Lightbars and Light Wire Looms

## LED LIGHT BARS - STRAIGHT

Operating Voltage: 12-24V DC

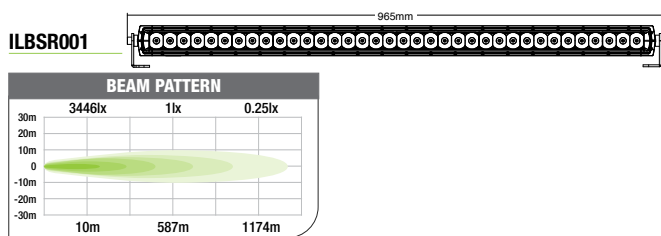
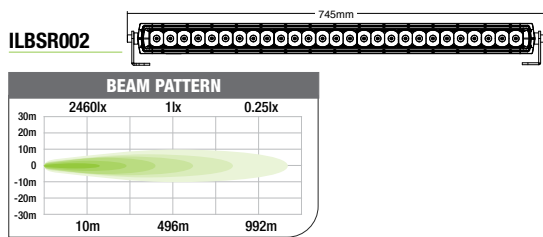
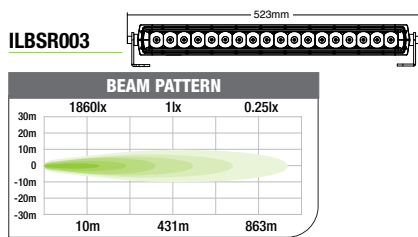
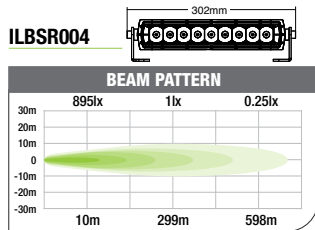
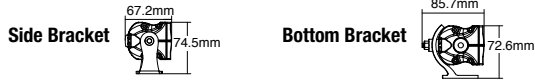

## LED LIGHT BARS - CURVED

Operating Voltage: 12-24V DC

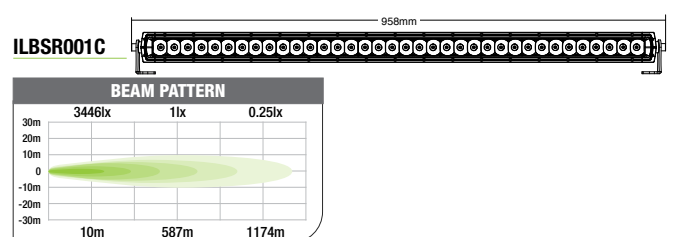
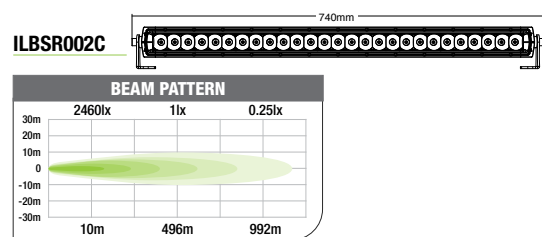
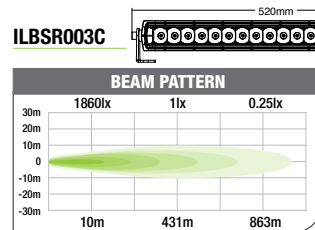

## LED LIGHT BARS - MODULAR

Operating Voltage: 12-24V DC

### ILED180S (SPOT)

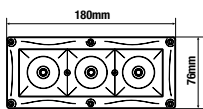

30W Spot Beam (7") Long

### ILED180F (FLOOD)

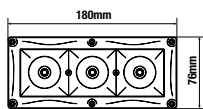

30W Flood Beam (7") Long

### MODULAR COMBINATIONS



Single Unit 6 Joined side by side



2 Joined side by side



3 Joined side by side



2 Stacked



4 Grouped

## LED DRIVING LIGHTS / LIGHTBAR WIRE LOOMS

### SINGLE LIGHT LOOM

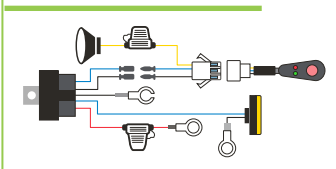

### TWIN LIGHT LOOM

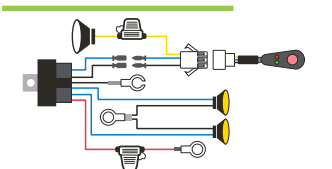

### TWIN LIGHT WITH DRL LOOM

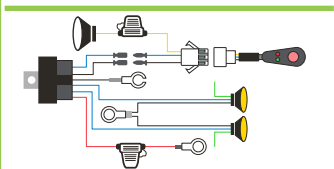

### TWIN MEGATOM LOOM

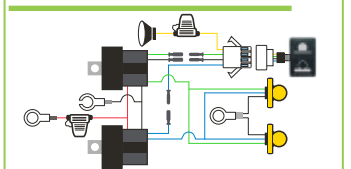

# Fridges and Fridge Troubleshooting

## FRIDGE ERROR CODES - ICE CUBE

Code	Error Type - Refer to User Manual for further information	Possible solution
<b>E1</b>	Battery protection stop auto cut-off (Battery too low or adjust protection setting)	Set battery protection to lower setting
<b>E2</b>	Fan fault (Check clearance around the fan)	Check for fan obstructions
<b>E3</b>	Compressor motor starter error (Low voltage power supply)	Check available voltage of 12/24V power supply, check all connections between battery and fridge, check condition of plug in lead
<b>E4</b>	Compressor motor running speed error (Overloaded motor cannot maintain 1850 times / min which is the lowest speed)	Return to place of purchase for assessment
<b>E5</b>	Compressor has over heated (Check clearance around the fan)	Check for sufficient air flow clearance around fridge
<b>ER1</b>	Control panel and temperature probe fault	Replacement of control panel or temperature probe

### Unit will not turn on

- Check power supply ie. Battery voltage (See Battery Protection table on Page 5 of User Handbook)
- Check all connections between battery and fridge
- Check condition of fuse
- Check that the unit is turned on

### Poor refrigeration performance

- Too much food has been placed inside refrigerator
- Temperature of food placed in fridge is too high
- The door is not closed properly
- Door seal is broken

### Poor cooling

- Make sure adequate ventilation room is left around unit (See General Notes Page 4 of User Handbook)
- Ambient temperature is extremely high
- Temperature is not set correctly

### Contents of fridge are freezing

- Temperature setting is too low

### Noise

- Unit is not on a flat or level surface
- Check for vibrations in surrounding objects

### Sound of water from inside of unit

- This is normal due to flow of refrigerant

## FRIDGE FAQ's

- Q.** Where can I find a list of the fault codes? **A.** See User Handbook (or above)
- Q.** Why is my fridge freezing everything? **A.** Temperature is set to degrees Fahrenheit, reset to degrees Celsius
- Q.** My fridge will not turn on? **A.** Hold On/Off button until the display illuminates
- Q.** My fridge isn't staying on? **A.** Check the battery protection setting, and ensure it is set correctly by referring to your User Handbook

# Fridges and Slides

## ICE CUBE FRIDGE / FREEZERS

### 30L ICECUBE FRIDGE / FREEZER - IFRIDGE30SP

Overall Dimensions 590(L) (650mm with handle) x 380(H) x 340mm(W)  
 Weight 18kg (35lb)  
 Temperature Range / Regulation +10 °C to -18 °C  
 Power Draw 4.5Amps

### 40L ICECUBE FRIDGE / FREEZER - IFRIDGE40SP

Overall Dimensions 590(L) (650mm with handle) x 440(H) x 350mm(W)  
 Weight 20kg (37lb)  
 Temperature Range / Regulation +10 °C to -18 °C  
 Power Draw 4.5Amps

### 50L ICECUBE FRIDGE / FREEZER - IFRIDGE50SP

Overall Dimensions 590(L) (650mm with handle) x 520(H) x 350mm(W)  
 Weight 22kg (41lb)  
 Temperature Range / Regulation +10 °C to -18 °C  
 Power Draw 4.5Amps

### 65L ICECUBE FRIDGE / FREEZER - IFRIDGE65SP

Overall Dimensions 820(L) x 495(H) x 490mm(W)  
 Weight 33kg (66lb)  
 Temperature Range / Regulation +10 °C to -18 °C  
 Power Draw 4.5Amps

### 74L ICECUBE FRIDGE / FREEZER - IFRIDGE74SP

Overall Dimensions 820(L) x 495(H) x 490mm(W)  
 Weight 32kg (66lb)  
 Temperature Range / Regulation +10 °C to -18 °C  
 Power Draw 4.5Amps

## FRIDGE SLIDES

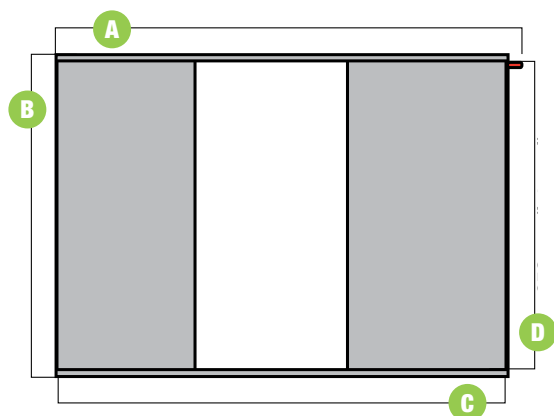

	IFRIDGESLIDE001	IFRIDGESLIDE002	IFRIDGESLIDE023	IFRIDGESLIDE045
<b>A</b>	655mm	843mm	796mm	896mm
<b>B</b>	420mm	534mm	576mm	676mm
<b>C</b>	352mm	811mm	750mm	850mm
<b>D</b>	592mm	484mm	430mm	530mm
<b>WEIGHT</b>	21kg	25kg	21kg	26kg



# Locksafe Drawer Systems

## LOCKSAFE DRAWER SYSTEMS

900mm Drawer System	Weight	Length (mm)	Height (mm)	Width (mm)
<b>TWIN</b> - Cabinet specifications including drawers*	63kg	900	275	970
<b>TWIN</b> - Drawer specifications		840	206	425
<b>SINGLE</b> - Cabinet specifications including drawers*	34kg	900	275	490
<b>SINGLE</b> - Drawer specifications		840	206	425

1000mm Drawer System	Weight	Length (mm)	Height (mm)	Width (mm)
<b>TWIN</b> - Cabinet specifications including drawers*	76kg	1000	275	1020
<b>TWIN</b> - Drawer specifications		940	206	450
<b>SINGLE</b> - Cabinet specifications including drawers*	39kg	1000	275	510
<b>SINGLE</b> - Drawer specifications		940	206	425

1300mm Drawer System	Weight	Length (mm)	Height (mm)	Width (mm)
<b>TWIN</b> - Cabinet specifications including drawers*	89kg	1300	275	970
<b>TWIN</b> - Drawer specifications		1240	206	425
<b>SINGLE</b> - Cabinet specifications including drawers*	46kg	1300	275	490
<b>SINGLE</b> - Drawer specifications		1240	206	425

\* Top of timber to underside of fixing ribs

### TWIN DRAWERS

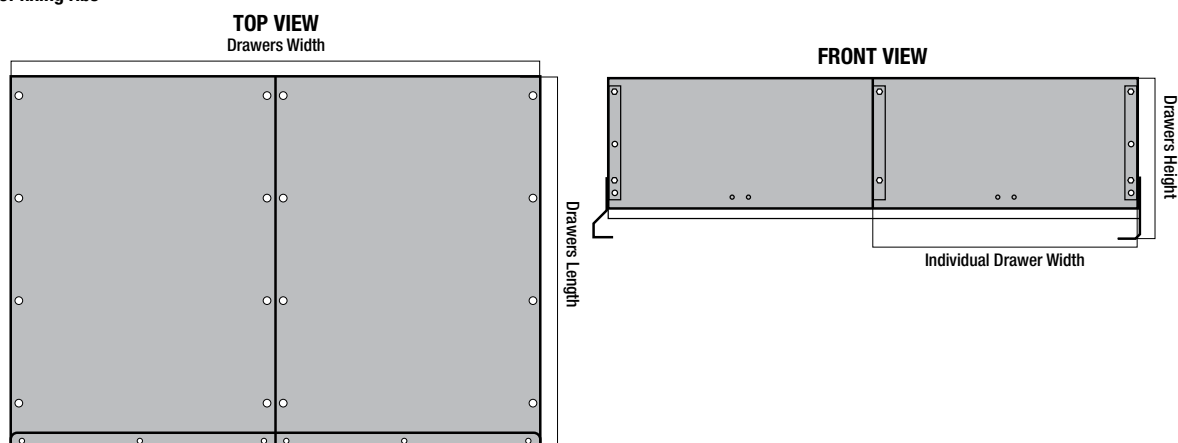

### SINGLE DRAWERS

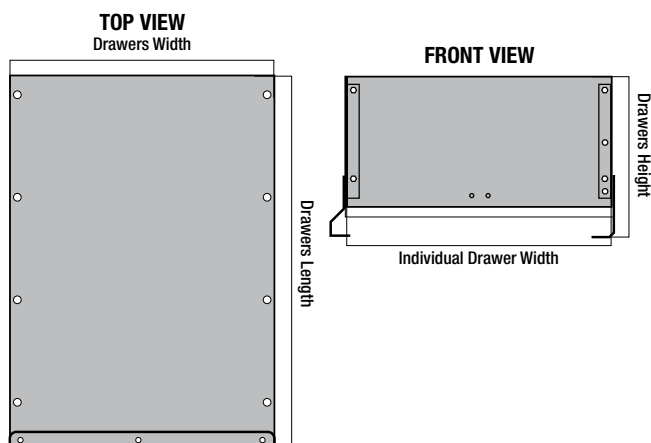

• All drawers extend 950mm from rear of unit. For an absolute overall width of each cabinet, add 26mm to the widths given above. Basic cabinet height is 238mm with 12mm carpeted ply on top and 20mm high fixing ribs under, giving an overall height of 270mm

REFER TO VEHICLE LISTING PAGES FOR SPECIFIC MODEL COMPATIBILITY / SUITABILITY

# DeltaWing Awnings

DELTAWING 270 XTR-143 - (WEIGHT 20KG)

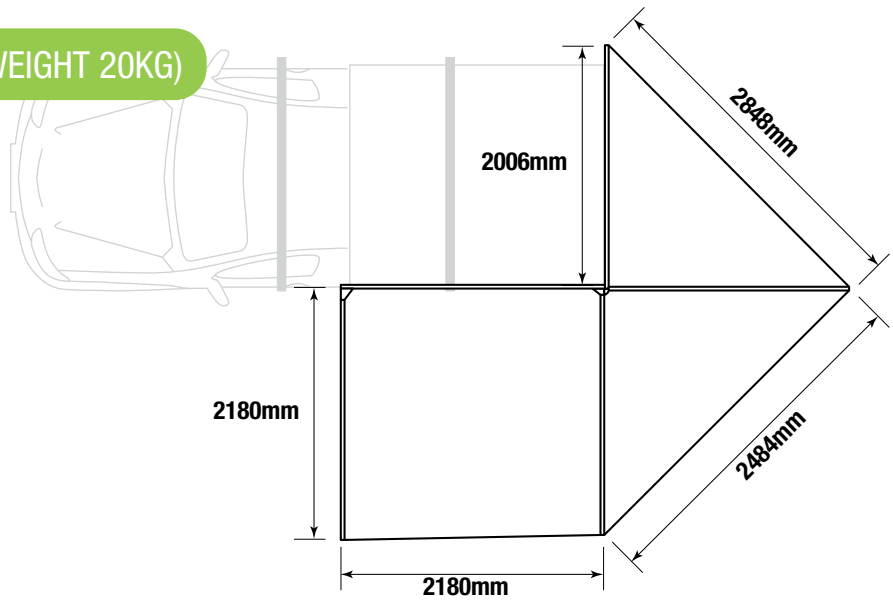

DELTAWING 270 XTR-71 - (WEIGHT 20KG)

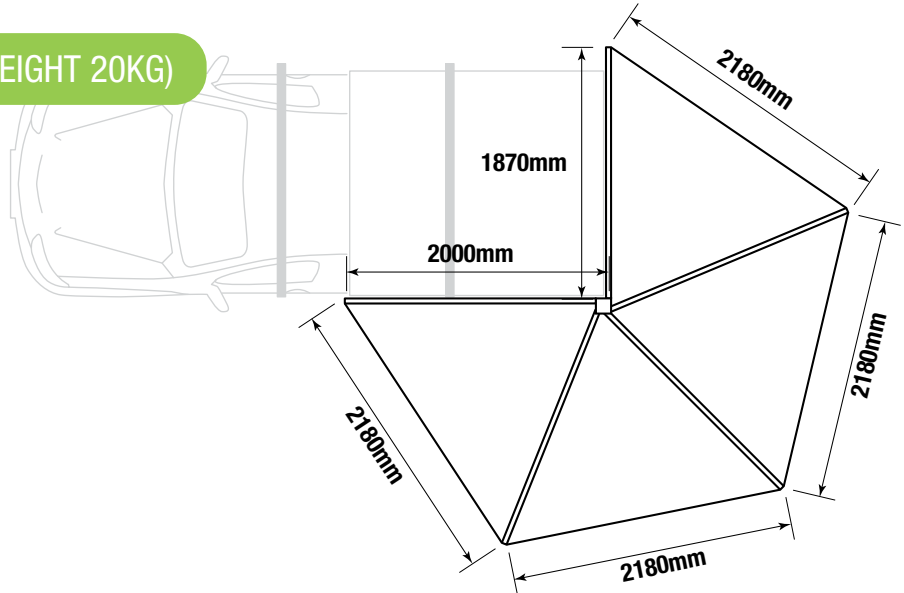

DELTAWING 270 XT-71 - (WEIGHT 18KG)

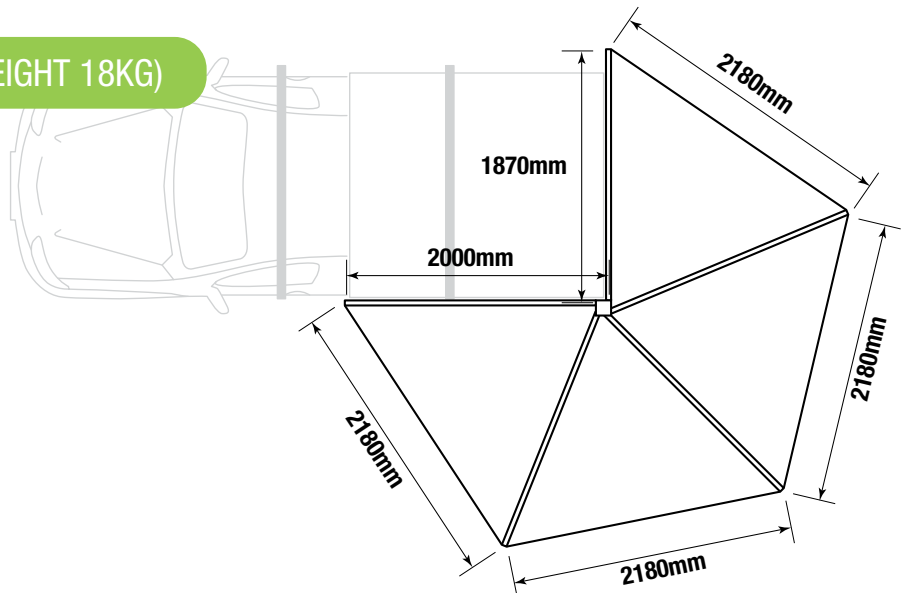

# Rooftop Tents

## SOFT ROOFTOP TENT - (WEIGHT 62KG)

OPEN

VIEW FROM FRONT

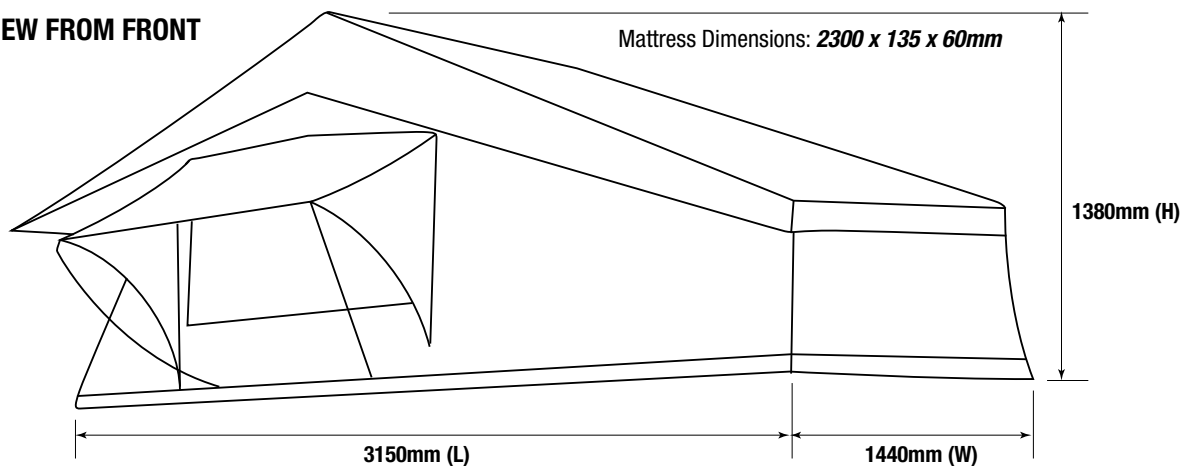

CLOSED

VIEW FROM PASSENGER SIDE

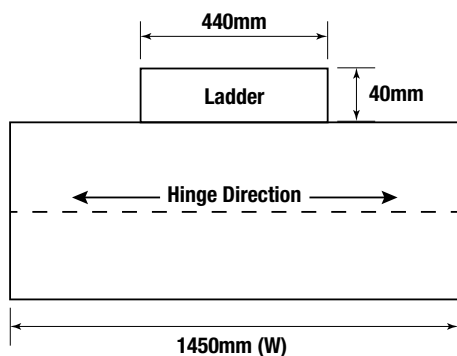

VIEW FROM FRONT

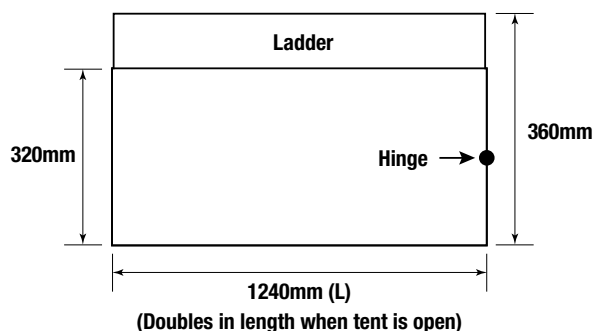

## SWIFT 1400 HARD TOP ROOFTOP TENT - (WEIGHT 92KG)

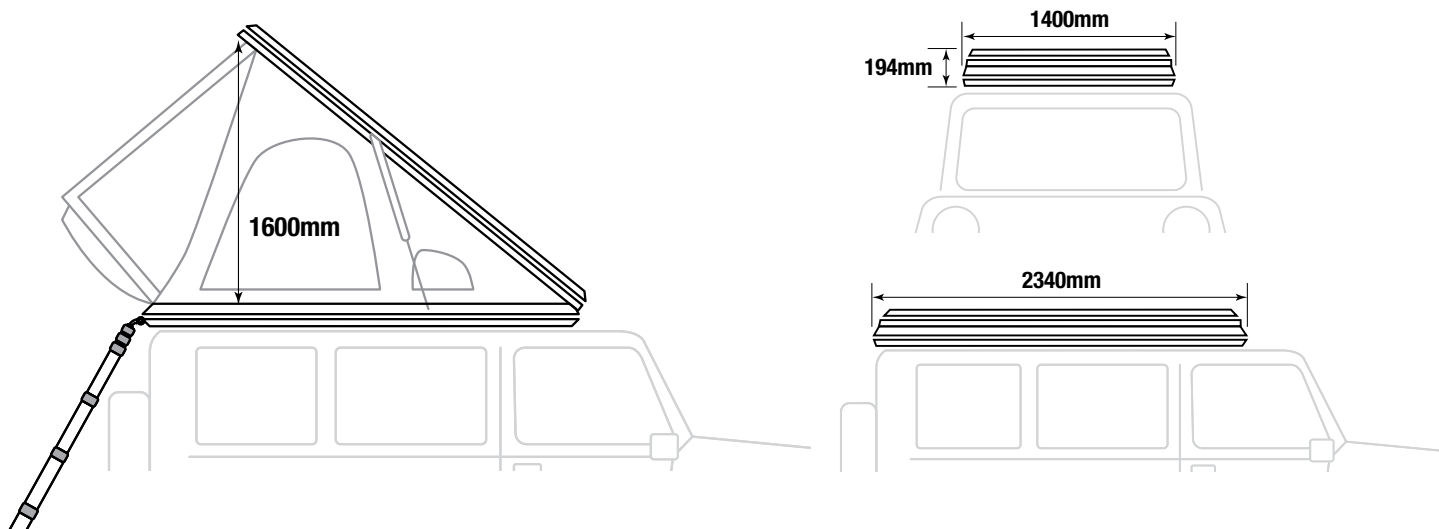

# Rooftop Tents and Rooftop Tent Awning

NOMAD 1300 ABS ROOFTOP TENT - (WEIGHT 69KG)

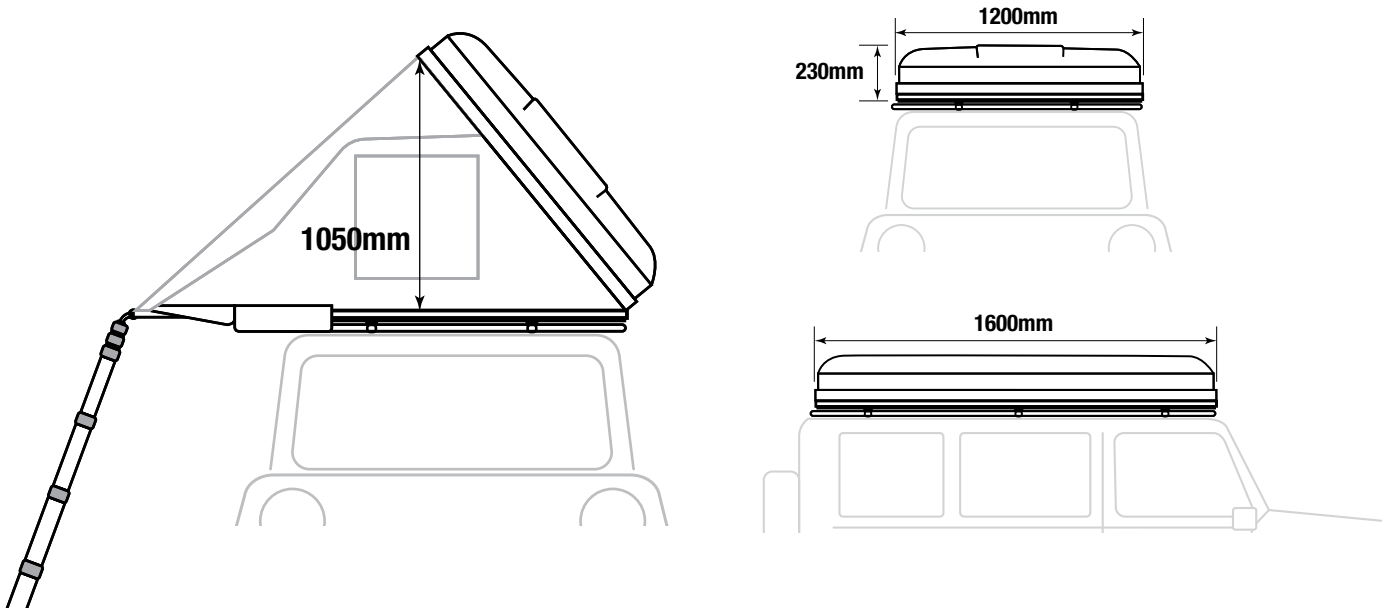

NOMAD 1300 ROOFTOP TENT AWNING - (WEIGHT 3KG)

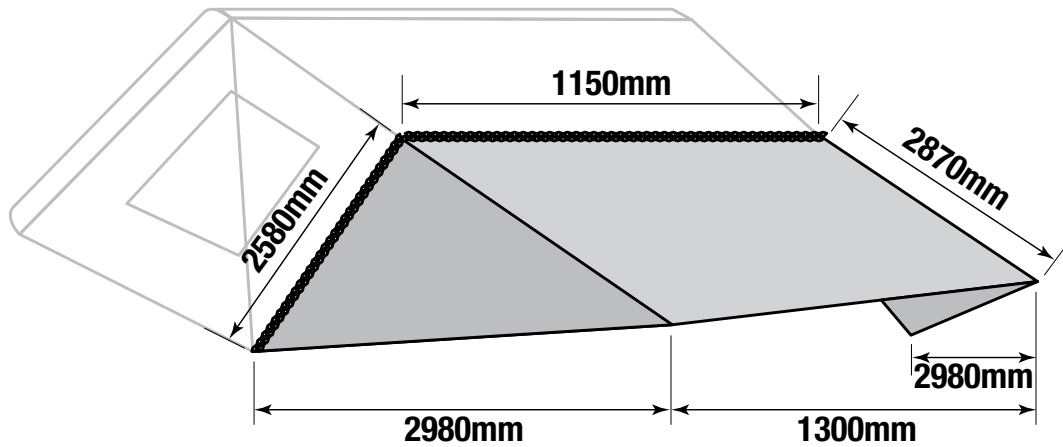

# Rooftop Tents

SOFT ROOFTOP TENT ANNEX WITH EXTENSION KIT - (WEIGHT 9KG)

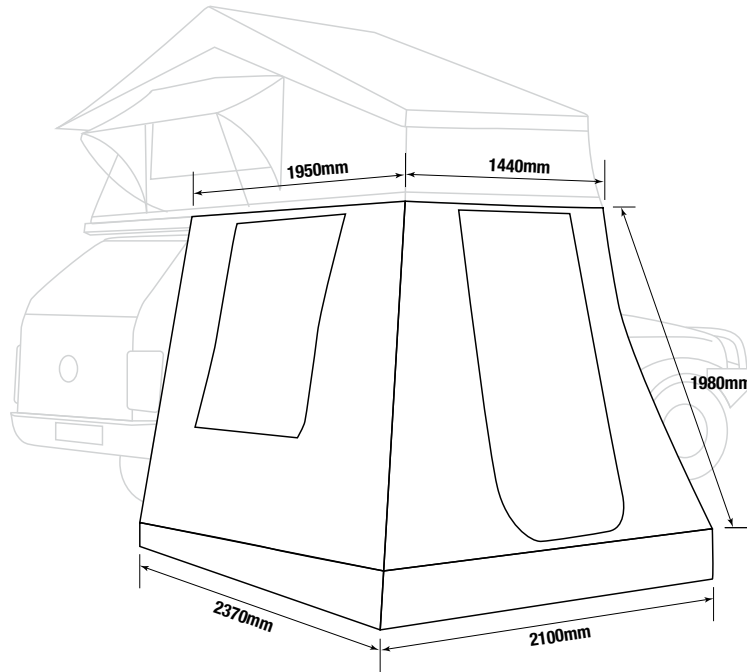

AWNING ROOM - (WEIGHT 11-12KG)

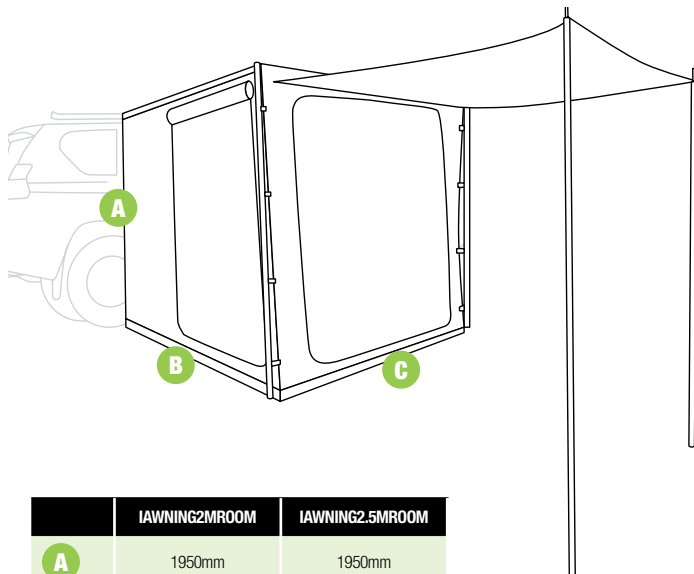

INSTANT ENSUITE - (WEIGHT 8KG)

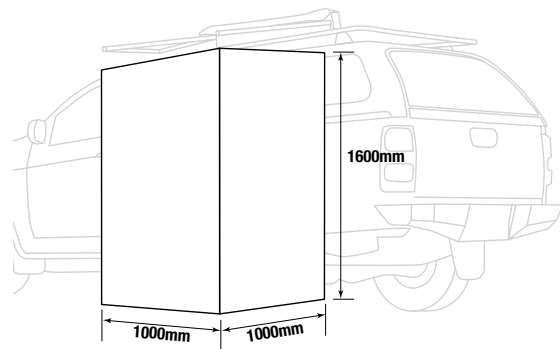

	IAWNING2MRROOM	IAWNING2.5MRROOM
<b>A</b>	1950mm	1950mm
<b>B</b>	1880mm	1800mm
<b>C</b>	2000mm	2500mm



# Rooftop Tents and Rooftop Tent Awning

## LED INSTANT AWNING

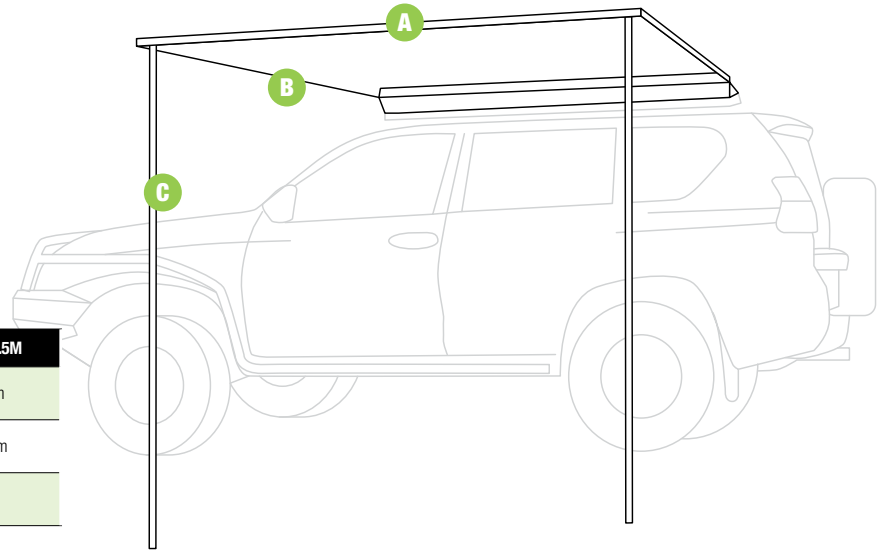

	IAWNING1.4M	IAWNING2M	IAWNING2.5M
<b>A</b>	1400mm	2000mm	2500mm
<b>B</b>	2000mm	2000mm	2000mm
<b>C</b>	Variable	Variable	Variable

## SWAGS

### SINGLE SWAG - HOOP DESIGN

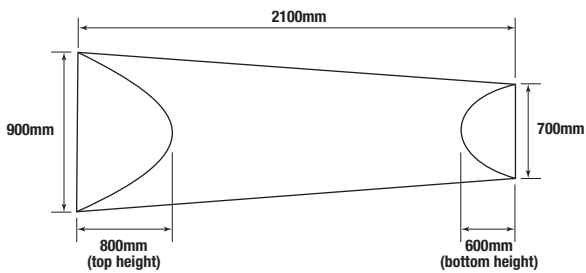

### DOUBLE SWAG - HOOP DESIGN

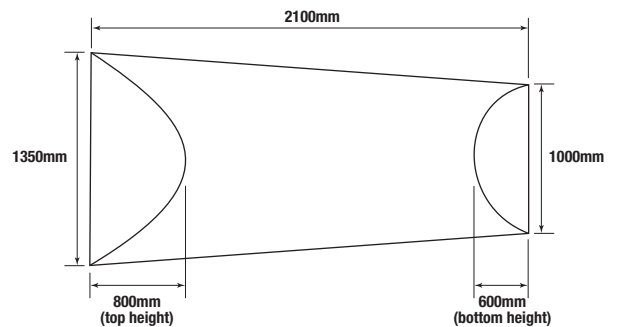

### KING SINGLE SWAG - RIDGE POLE DESIGN

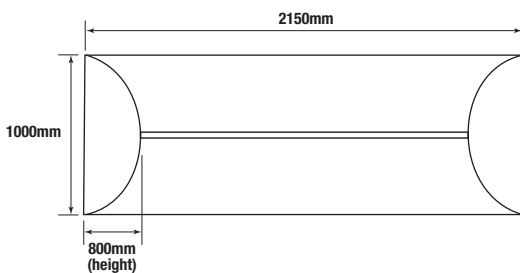

### DOUBLE SWAG - RIDGE POLE DESIGN

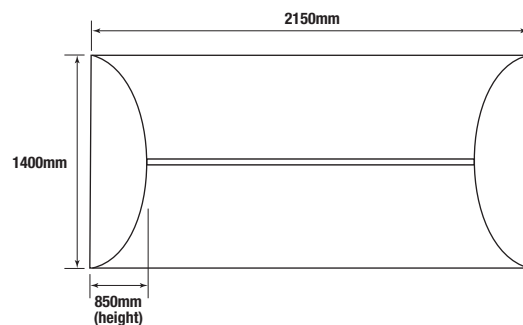

**WATER TANKS**

**IWT001 - 20L JERRY CAN**

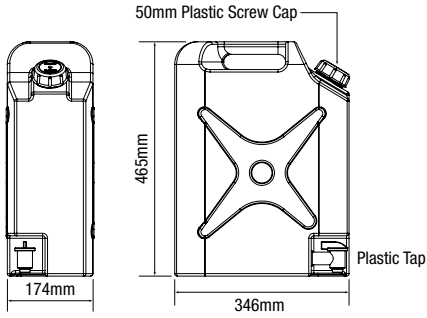

**IWT002 - 40L JERRY CAN**

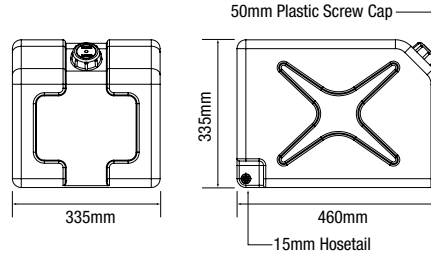

**IWT003 - 40L VERTICAL TANK**

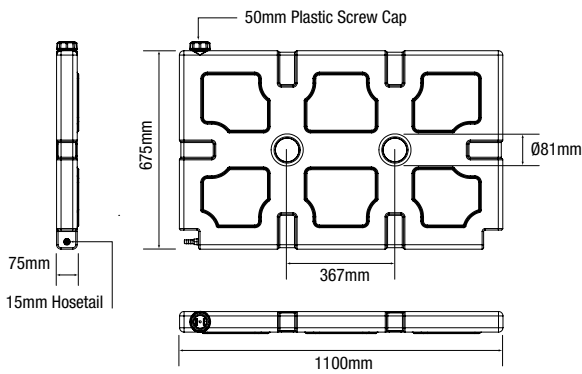

**IWT004 - 50L ROOF RACK TANK**

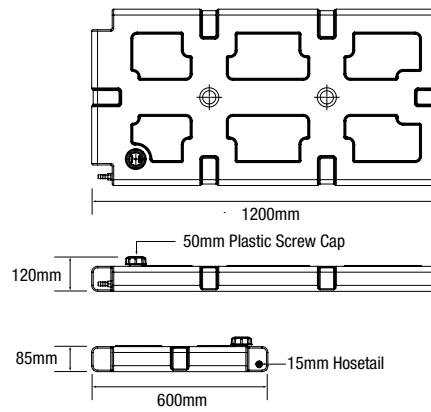

**IWT005 - 50L WHEEL ARCH TANK**

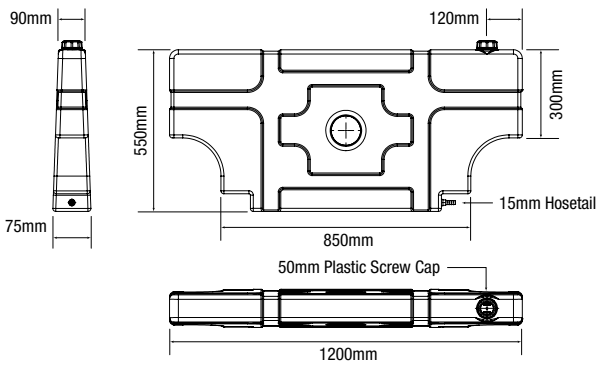

**IWT006 - 50L TAPERED TANK**

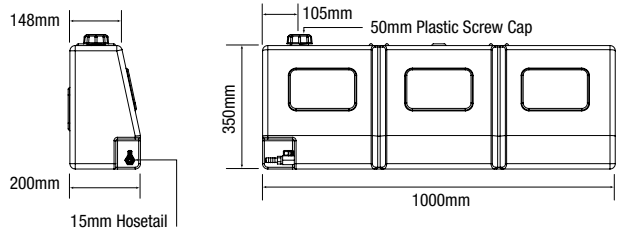

**IWT007 - 60L TANK**

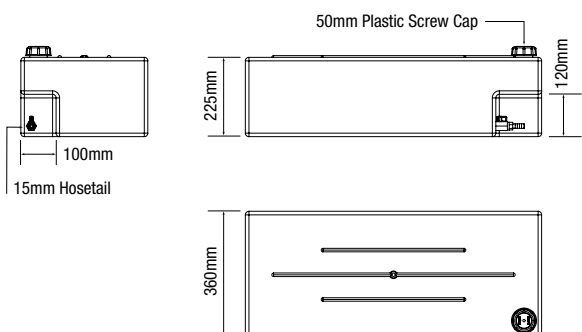

**IWT008 - 15L UNDER TRAY HAND WASH TANK**

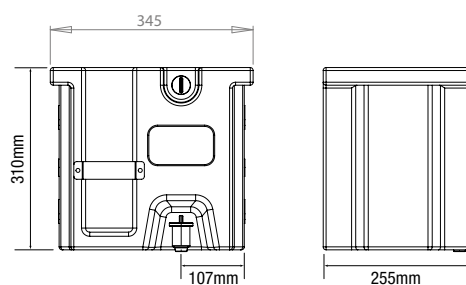

# *Quick Reference Index*



# Product Codes

Part Number	Page	Part Number	Page	Part Number	Page	Part Number	Page
98	370						
99	370						
344	337						
345	337						
346	337, 339						
347	337						
351	327, 331, 332, 333, 334, 335, 336, 338						
354	327, 331						
384	292, 293						
385	268, 292, 293						
386	268, 292, 293						
470	234, 235						
635	370						
664	234, 235						
665	234						
667	227, 229						
791	73, 74, 93, 113, 114						
792	73, 74, 93, 113, 114						
794	66, 157						
795	171, 173, 176, 189, 191, 193, 194, 195						
796	171, 173, 176, 195						
797	207, 208						
798	207, 208, 209						
1141	310, 313, 317, 321, 325, 330						
1142	310, 313, 317, 321, 325, 330						
1144	301, 306, 309, 312, 316, 320, 324, 330						
1147	54, 58, 62, 94, 152						
1148	81, 84, 102, 105, 143						
1149	144						
1150	353						
1155	280, 284						
1156	99, 148						
1189	356, 357						
1199	47, 181, 185						
3501	220						
3502	140						
3511	137, 141, 220, 224, 227						
3517	170, 171, 172, 173, 193, 194, 195						
3521	292, 293						
3522	229, 234, 235, 336, 337, 338, 339						
3524	301, 306, 309, 320, 327, 328, 329, 331, 332, 334						
3525	309, 312, 316, 320, 324, 330						
3530	259						
3532	134, 135, 136						
3533	267, 268, 291						
3534	230, 232						
3536	230, 232						
3540	117, 123, 127, 128						
3541	127						
3542	255						
3543	119, 125						
3544	119, 125						
1002K	227, 230, 232						
1084UK	317, 321						
1085UK	310, 313, 325						
1100UBK	227						
1100UBKL	227						
1102UBK	189, 191						
1103UBK	144						
1104UBK	199, 202						
1105UBK	246						
1106UBK	276						
1107UBK	94						
1141-1	325, 330						
1144R	428						
1144RK	220, 224, 227, 230, 232, 301, 306, 309, 312, 316, 320, 324, 330						
1144SK	220, 224, 227, 230, 232, 301, 306, 309, 312, 316, 320, 324, 330						
1145SK	134, 135, 136, 137, 141						
1146RK	255, 257, 258						
1151UK	289						
1152K	99, 102, 105, 148						
1153UK	246						
1154UK	276						
1185UK	330						
1188UK	356, 357						
1190UK	359, 361						
1191UK	351						
1192K	273, 275, 280, 284, 351						
1193UK	54, 58, 62, 152						
1194K	54, 58, 62, 152						
1195UK	94						
1196UK	353						
1197K	353						
1198K	265, 271, 275, 287, 341, 344, 346						
1200UK	47, 181, 185						
1201K	47, 181, 185						
1202K	121						
1203K	58, 62, 152						
1204K	161, 198, 201, 241						
1205K	47, 181, 185						
12075GR	234, 235						
12076GR	234, 235						
1207K	143						
12080GR	134, 135, 136, 137, 141						
12081GR	280, 284, 287, 291, 327, 330						
12081GRC	280, 284, 287, 291, 327, 330						
12082GR	172, 173, 194, 195						
12083GR	262, 263						
12085GR	259						
12086GR	259						
12087GR	73, 74, 93, 97, 113, 114, 144, 145, 170, 171, 175, 176, 193, 208						
12088GR	267, 268, 291						
12089GR	262, 263						
1208K	143						
12091GR	220, 224, 227, 230, 232, 309, 312, 316, 320, 324, 329, 330						
12094GR	221, 225, 230, 232, 309, 313, 317, 321, 325						
12094GRC	309, 313, 317, 321, 325						
12095GR	54, 58, 62, 65, 66, 94, 152, 155, 157						
12095GRC	54, 58, 62, 65, 66, 94, 152, 155, 157						
1209K	265, 271, 341, 344, 351						
1210K	273, 280, 284						
1211K	255						
1213K	280, 284						
1214K	54, 68						
1215K	250, 252, 253						
1216K	250, 253						
1217K	94, 353						
1218ADK	265, 341, 344, 347						
1218R	271, 341, 344, 347						
1219R	255						
1220K	265, 341, 344, 347						
12635GR	336, 337, 338, 339						
12635GRC	336, 337, 338, 339						
12636GR	74, 81, 84, 86, 88, 90, 92, 93, 102, 105, 107, 109, 114, 143, 171, 173, 176, 189, 191, 194, 195, 207, 208, 215, 293, 335, 336, 337, 338, 339						
12636GRC	74, 81, 84, 86, 88, 90, 92, 93, 102, 105, 107, 109, 114, 143, 171, 173, 176, 189, 191, 194, 195, 207, 208, 215, 293, 335, 336, 337, 338, 339						
12636GRP	81, 84, 86, 88, 90, 92, 93, 102, 105, 107, 109, 114, 143, 171, 173, 176, 189, 191, 194, 195, 207, 208, 215, 293, 335, 336, 337, 338, 339						
12637GR	97, 267, 327, 331, 332, 334						
12637GRC	97, 267, 327, 331, 332, 334						
12637GRS	357						
12639GR	292, 293						
12639GRC	292, 293						
12639GRS	329						
12640GR	134, 135, 136, 137, 141						
12643GR	72, 92, 112						
12644GR	72, 92, 112						
12645GR	172, 175						
12645GRC	172, 175						
12645GRS	163, 165, 174						
12646GR	170						
12648GR	227, 229						
12650GR	129, 268, 287, 289, 292, 329, 331, 333						
12650GRC	129, 268, 287, 289, 292, 329, 331, 333						
12652GR	356						
12658GR	262, 263						
12661GR	229, 266, 349						
12661GRS	247						
12665GR	117, 123, 128						
12666GR	117						
12667GR	65, 66, 75, 88, 90, 109, 155, 157, 177, 215, 247, 277						
12669GR	128						
12670GR	123						
12671GR	73, 113, 177						
12682GR	271, 301, 306						
12682GRC	265, 271, 341, 344, 347						
12682GRP	265, 271, 341, 344, 347						
12683GR	301, 306						
12691GR	266, 349						



# Product Codes

Part Number	Page	Part Number	Page	Part Number	Page	Part Number	Page
12696GR	328	12751GR	127	12834014GRP	252	24635FEC	336, 337, 338, 339
12697GR	328	12751LGR	127	12835011GR LH	253		74, 81, 84, 86, 88, 90, 92, 93, 102, 105, 107, 109, 114, 143, 171, 173, 176, 189, 191, 194, 195, 208, 215, 293, 335, 336, 337, 338, 339
12698GR	99, 148, 177, 193, 199, 202, 209, 356, 357	12752GR	127	12835011GR RH	253	24636FE	
12698GRC	99, 148, 193, 199, 202, 209	12752LGR	127	12835011GRP LH	253		74, 81, 84, 86, 88, 90, 92, 93, 102, 105, 107, 109, 114, 143, 171, 173, 176, 189, 191, 194, 195, 208, 215, 293, 335, 336, 337, 338, 339
12698GRP	99, 148, 193	12755GR	354	12835011GRP RH	253	24636FEC	
12710GR	95, 129, 265, 271, 275, 287, 341, 346, 351	12759GR	255, 257	12836012GR	253		74, 81, 84, 86, 88, 90, 92, 93, 102, 105, 107, 109, 114, 143, 171, 173, 176, 189, 191, 194, 195, 208, 215, 293, 335, 336, 337, 338, 339
12711GR	115, 116	12760GR	255, 257	12836012GRP	253	24636FEP	
12712GR	115, 116	12764GR LH	289	12845GR	99, 148		74, 81, 84, 86, 88, 90, 92, 93, 102, 105, 107, 109, 114, 143, 171, 173, 176, 189, 191, 194, 195, 208, 215, 293, 335, 336, 337, 338, 339
12713GR	168	12764GR RH	289	12851GR	119, 125	24637FE	267, 327, 331, 332, 334
12714GR	168	12765GR	355	12851GRC	119, 125	24637FEC	267, 327, 331, 332, 334
12715GR	46, 163, 165, 174, 180, 184, 188, 191	12774GR	122	12852GR	125	24637FES	357
12716GR	161, 198, 199, 201, 202, 204, 205, 211, 213, 236, 241	12775GR	122	12852GRC	125	24639FE	292, 293
12717GR	204, 205, 236	12776GR	140	12853GR	94	24639FES	329
12718GR	211, 213	12777GR	140	2244AK	418, 419, 420	24640FE	134, 135, 136, 137, 141
12720GR	296, 299	12791GR	207, 209	2244K	418, 419, 420, 421, 422, 424	24643FE	72, 112
12721GR	261	12795GR	304	24080FE	134, 135, 136, 137, 141	24644FE	72, 75, 112
12722GR	261	12796GR	296, 299, 304	24081FE	280, 284, 287, 291, 327	24645FE	172, 175
12725GR	359, 361	12797GR	86, 107	24081FEC	280, 284, 287, 291, 327, 330	24645FEC	172, 175
12726GR	359, 361	12804GR	95	24081FEP	280, 284, 287, 291, 327, 330	24645FES	163, 165, 174
12727GR	58, 62, 70, 152	12805GR	277	24082FE	172, 173, 194, 195	24646FE	170
12728GR	161, 198, 201, 241	12805GRC	277	24087FE	73, 74, 93, 97, 113, 114, 170, 171, 175, 176, 193, 208	24648FE	227, 229
12729GR	47, 181, 185	12811GR	158	24088FE	267, 268, 291	24650FE	129, 268, 287, 289, 292, 329, 331, 333
12729GRC	47, 181, 185	12812GR	158	24091FE	220, 224, 227, 230, 232, 309, 312, 316, 320, 324, 329, 330	24650FEC	129, 268, 287, 289, 292, 331, 333
12729GRP	47, 181, 185	12823GR	244, 245, 246, 249	24091FEP	220, 224, 230, 232	24650FEP	129, 268, 287, 289, 292, 331, 333
12730GR	273, 280, 284	12824GR	244	24091LFE	220, 224, 230, 232	24652FE	356
12731GR	144	12825GR	245	24091LFE1	220, 224, 230, 232	24661FE	229, 266, 349
12732GR	68, 70	12826GR	246	24091LFE1	220, 224, 230, 232	24661FES	247
12735GR	121	12827GR	54, 68	24094FE	221, 225, 230, 232, 309, 313, 317, 321, 325	24665FE	117, 123, 128
12738GR LH/RH	121	12828GR	249	24094FEC	309, 313, 317, 321, 325	24666FE	117
12740GR	217	12830007GR LH	250	24094FEP	221, 225, 230, 232, 309, 313, 317, 321, 325	24667FE	65, 66, 75, 88, 90, 109, 155, 157, 177, 215, 247, 277
12742GR	217	12830007GR RH	250	24094LFE	221, 225, 230, 232, 309, 313, 317, 321, 325	24682FE	271, 301, 306
12743GR	273, 275	12830007GRP LH	250	24094LFE1	221, 225, 230, 232	24682FEC	265, 271, 341, 344, 347
12743GRC	273, 275	12830007GRP RH	250	24094LFE1	221, 225, 230, 232	24682FEP	265, 271, 341, 344, 347
12744GR	351	12831009GR LH	252	24094LFEC	309, 313, 317, 321, 325	24682LFE	301, 306
12745GR	77, 79, 81, 84, 102, 105, 111, 142	12831009GR RH	252	24094LFEP	221, 225, 230, 232, 309, 313, 317, 321, 325	24682LFE1	301, 306
12746GR	77, 79, 111	12832008GR	250	24095FE	54, 58, 62, 65, 66, 94, 152, 155, 157	24683FE	301, 306
12746GRC	77, 79, 111	12832008GRP	250	24095FEC	54, 58, 62, 65, 66, 94, 152, 155, 157	24683LFE	301, 306
12747GR	44, 242	12833009GR LH	252	24095FEP	54, 58, 62, 65, 66, 94, 152, 155, 157		
12748GR	44, 242	12833009GR RH	252				
12749GR	144, 145	12833009GRP LH	252				
12750GR	344	12833009GRP RH	252				
		12834010GR	252				
		12834010GRP	252				
		12834014GR	252				



# Product Codes

Part Number	Page
24683LFE1	301, 306
24691FE	266, 349
24696FE	328
24697FE	328
24698FE	99, 148, 193, 199, 202, 209, 356, 357
24698FEC	99, 148, 193, 199, 202, 209
24698FEP	99, 148, 193, 199, 202, 209
24710FE	95, 129, 265, 271, 275, 287, 341, 346, 351
24713FE	168
24715FE	46, 163, 165, 174, 180, 184, 188, 191
24716FE	161, 198, 199, 201, 202, 204, 205, 211, 213, 236, 241
24717FE	204, 205, 236
24717FEP	204, 205, 236
24718FE	211, 213
24720FE	296, 299
24727FE	58, 62, 70, 152
24728FE	161, 198, 201, 241
24728FEP	161, 198, 201, 241
24729FE	47, 181, 185
24729FEC	47, 181, 185
24729FEP	47, 181, 185
24730FE	273, 280, 284
24732FE	68, 70
24740FE	217
24742FE	217
24743FE	273, 275
24743FEC	273, 275
24744FE	351
24745FE	77, 79, 81, 84, 102, 105, 111, 142
24746FE	77, 79, 111
24746FEC	77, 79, 111
24750FE	344
24776FE	140
24777FE	140
24780FE	353
24781FE	353
24788FE	159
24789FE	159
24795FE	304
24796FE	296, 299, 304
24804FE	95

Part Number	Page
24805FE	277
24811FE	158
24812FE	158
24827FE	54, 68
24840FE LH	276
24840FE RH	276
24842FE	276
24842FEC	276
24845FE	99, 148
24853FE	94
343LH	337, 339
343RH	337, 339
348LH	327, 331, 332, 334, 336, 338
348RH	327, 331, 332, 334, 336, 338
3521S	257
353LH	144, 227, 229, 327, 331, 333, 335, 336
353RH	144, 227, 229, 327, 331, 333, 335, 336
355K	235
386-1	65, 66, 155, 157, 291
386-2	86, 88, 90, 82, 107, 109, 268, 292, 293
386-3	129, 287, 289
387-1	47, 54, 58, 62, 81, 84, 88, 90, 92, 94, 99, 102, 105, 109, 129, 143, 148, 152, 181, 185, 189, 191, 193, 194, 280, 284, 287, 289, 291
415UBK	66, 92, 157, 277, 289, 330, 331, 333, 335, 336, 337, 338, 339, 359, 361
416UBK	236, 310, 313, 317, 321, 325, 327
416UBKL	310, 313, 317, 321
417UBK	54, 58, 62, 65, 86, 88, 90, 107, 109, 152, 155
436UBK	229, 327, 331, 332, 334
437UBK	47, 181, 185, 204, 205, 268, 287, 291, 292, 293, 351
437UBKL	47, 81, 84, 99, 102, 105, 129, 143, 148, 181, 185, 204, 205, 280, 284, 287, 291
449UBK	336
45080FE	134, 135, 136, 137, 141
45081FE	280, 284, 287, 327, 330
45081FEC	280, 284, 287, 327, 330
45081FEP	280, 284, 287, 327, 330

Part Number	Page
45091FE	220, 224, 227, 230, 232, 309, 312, 316, 320, 324, 330
45091FEP	220, 224, 227, 230, 232, 309, 312, 316, 320, 324, 330
45091LFE	220, 224, 230, 232
45091LFE1	220, 224, 230, 232
45091LFEP	220, 224, 230, 232
45094FE	221, 225, 230, 232, 309, 313, 317, 321, 325
45094FEC	309, 313, 317, 321, 325
45094FEP	221, 225, 230, 232, 309, 313, 317, 321, 325
45094LFE	221, 225, 230, 232, 309, 313, 317, 321, 325
45094LFE1	221, 225, 230, 232
45094LFEC	309, 313, 317, 312, 325
45094LFEP	221, 225, 230, 232, 309, 313, 317, 321, 325
45095FE	54, 58, 62, 65, 66, 94, 152, 155, 157
45095FEC	54, 58, 62, 65, 66, 94, 152, 155, 157
45095FEP	54, 58, 62, 66, 94, 152, 155, 157
451UBK	73, 74, 93, 113, 114, 171, 173, 176, 193, 194, 195, 234, 235
452UBK	234, 235
453UBK	234, 235
45635FE	336, 337, 338, 339
45636FE	81, 84, 102, 105, 143, 189, 191, 335, 336, 337, 338, 339
45636FEC	81, 84, 102, 105, 143, 189, 191, 335, 336, 337, 338, 339
45636FEP	81, 84, 102, 105, 143, 189, 191, 335, 336, 337, 338, 339
45637FE	327, 331, 332, 334
45637FEC	327, 331, 332, 334
45640FE	134, 135, 136, 137, 141
45648FE	227, 229
45650FE	
45650FEC	129, 287, 331, 333
45650FEP	129, 331, 333
45661FE	229, 266, 349
45667FE	65, 66, 155, 157
45682FE	271, 301, 306
45682FEC	265, 271, 341, 344, 347

Part Number	Page
45682FEP	265, 271, 341, 344, 347
45682LFE	301, 306
45682LFE1	301, 306
45683FE	301, 306
45683LFE	301, 306
45683LFE1	301, 306
45691FE	266, 349
45698FE	99, 148, 199, 202
45698FEC	99, 148, 199, 202
45698FEP	99, 148, 199, 202
45710FE	129, 265, 271, 275, 287, 341, 346, 351
45715FE	46, 163, 165, 180, 184, 188, 191
45716FE	161, 198, 199, 201, 202, 204, 205, 211, 213, 236, 241
45716LFE	198, 199, 201, 202, 204, 205, 211, 213, 236, 241
45717FE	204, 205, 236
45717FEP	204, 205, 236
45720FE	296, 299
45727FE	58, 62, 70, 152
45728FE	161, 198, 201, 241
45728FEC	161, 198, 201, 241
45728FEP	161, 198, 201, 241
45729FE	47, 181, 185
45729FEC	47, 181, 185
45729FEP	47, 181, 185
45730FE	273, 280, 284
45732FE	68, 70
45740FE	217
45742FE	217
45743FE	273, 275
45743FEC	273, 275
45744FE	351
45745FE	77, 79, 81, 84, 102, 105, 111, 142
45746FEC	77, 79, 111
45750FE	344
45751FE	127
45751LFE	127
45752FE	127
45752LFE	127
45780FE	353
45781FE	353
45795FE	304

# Product Codes

Part Number	Page	Part Number	Page	Part Number	Page	Part Number	Page
45796FE	296, 299, 304	713UK	337, 339	847RK	302, 307	BB064-SL	340
45796FEP	296, 299, 304	714UK	337	848CRK	221	BB064-TL	340
45802FE	160	715STUK	176	848RK	221	BB065-SL	282
45803FE	160	715TUK	171, 189, 191, 193, 194	848RT	428	BB065-TL	282
45827FE	54, 68	715UK	173, 195	ADL001	301, 306	BB066-SL	52, 67
45845FE	99, 148	718UK	229	ADL001L	301, 306	BB066-TL	52, 67
45851FE	119, 125	719UK	144, 227, 229, 327, 331, 332, 333, 334, 335, 336, 338	ADL003	224, 227, 230, 232	BB067-SL	178
45851FEC	119, 125	720UK	327	ADL005	220	BB067-TL	178
45852FE	125	721UK	235	ADL070	309, 312, 316	BB068-SL	142
45852FEC	125	722UK	234, 235	ADL106	292, 293	BB068-TL	142
45853FE	94	724UK	234	AFPAD001	370	BB074-SL	98
45854FE	119	728TUK	88, 90, 109	AFPAD002	370	BB074-TL	98
45854FEC	119	728UK	86, 92, 93, 107	ATR001	301, 306	BB076-SL	278
45855FE	239	728UKL	277	ATR003	224, 227, 230, 232	BB076-TL	278
45855LFE	239	732UK	292, 293	ATR005	220	BB079-SL	162
45856FE	239	733UK	268, 292, 293	ATR070	309, 312, 316	BB079-TL	162
45856FEC	239	734UK	259	B9MK	424	BB080-SL	147
45856LFE	239	747UK	73, 74, 113, 114	BB030-SL	274	BB080-TL	147
45856LFEC	239	756UK	66, 157	BB030-TL	274	BB081-SL	272
45860FE	238	758UK	291	BB038-SL	60	BB081-TL	272
45862FE	238	759UK	65, 155	BB038-TL	60	BBA048	200, 240
45862FEC	238	762UK	117	BB039-SL	150	BBA050	45, 182
45RSS001	421, 422	767UK	129, 280, 284, 287, 289	BB039-TL	150	BBA051	282
45RSS002	422	769UK	204, 205, 236	BB048-SL	200, 240	BBA056-VX	295
45RSS003	422	769UKL	209	BB048-TL	200, 240	BBA065	282
45RSS004	421	770UK	81, 84, 99, 102, 105, 143, 148	BB050-SL	45, 182	BBC002	286
45RSS005	422	788UBK	207, 208	BB050-TL	45, 182	BBC018	308, 319, 326
45SK6520	421, 422	797-1	204, 205, 236	BB051-SL	282	BBC019E	308, 311, 315, 323
45SK7218	422	797-2	209	BB051-TL	282	BBC019SC	308
45SK7220	421, 422	797-3	199, 202	BB053-SL	272	BBC023	133
45TAR001	421, 422	832RT	428	BB053-TL	272	BBC030	274
45TAR002	421, 422	833R	428	BB054-SL	56, 69	BBC031	187
512UBK	117	833WT	220, 224, 227, 230, 232	BB054-TL	56, 69	BBC033	286
632PF	418, 419, 420, 421, 422, 424	834RT	428	BB056-SL	295	BBC038	60
635R	421	836RT	428	BB056-TL	295	BBC039	150
635RK	418, 419, 420, 421	839CRK	221, 225, 231, 233	BB057-SL	76, 80	BBC040	83
654UBK	209, 259	839RK	221, 225, 231, 233	BB057-TL	76, 80	BBC041	104
655UBK	259	840RT	428	BB058-SL	101	BBC043	298
656R	418, 420	841RT	428	BB058-TL	101	BBC047	343
656RK	418, 419, 420, 421, 422	843RT	428	BB059-EXCEED KIT	164	BBC048	200, 240
669UBK	229	844RT	428	BB059-SL	164	BBC050	45, 182
670UBK	229	845RT	428	BB059-TL	164	BBC051	282
678UBK	81, 84, 99, 102, 105, 148, 292, 293, 353, 356, 357	846RT	428	BB060-SL	358	BBC055	52, 56, 67, 69
704TUK	199, 202	847CRK	302, 307	BB060-TL	358	BBC056	295
704UK	207, 208			BB061-SL	110	BBC057	76, 80
				BB061-TL	110	BBC058	101

# Product Codes

Part Number	Page	Part Number	Page	Part Number	Page	Part Number	Page
BBC065	282	BBCD059	164	BBPART025	364	BBR077	118, 124, 126
BBC065-NB	282	BBCD060	358	BBPART026	364	BBR077ST	118, 124, 126
BBCD001	290	BBCD061	110	BBPART031	27, 364	BBR078	264
BBCD002	286	BBCD063	256	BBPARTLOOP001	364	BBS070	254
BBCD003	91	BBCD065	282	BBPARTLOOP002	364	BBT012	203, 210
BBCD004	305	BBCD066	52, 67	BBPARTLOOP003	364	BBT013	206
BBCD005	300	BBCD067	178	BBPARTLOOP004	364	BBT014	64
BBCD006	303	BBCD068	142	BBPARTLOOP005	364	BBT016	190
BBCD007	348	BBCD070	254	BBPARTLOOP007	364	BBT019SC	308
BBCD008	346	BBCD071	243, 248	BBPARTLOOP008	364	BBT024	154
BBCD009	219	BBCD074	98	BBPARTLOOP009	364	BBT027	87
BBCD010	228	BBCD076	278	BBPARTLOOP010	364	BBT030	274
BBCD012	203, 210	BBCD076-NB	278	BBPARTLOOP011	364	BBT030-NL	274
BBCD013	206	BBCD079	162	BBPARTLOOP012	364	BBT031	187
BBCD014	64	BBCD080	147	BBPARTLOOP013	364	BBT033	286
BBCD016	190	BBCD081	272	BBPARTLOOP014	364	BBT034	360
BBCD018	308, 319, 326	BBCD082	197	BBPARTLOOP016	364	BBT038-NL	60
BBCD020	89, 108	BBP011	218	BBPARTLOOP019	364	BBT039-NL	150
BBCD024	154	BBP019E	308, 311, 315, 323	BBPARTLOOP020	364	BBT041	104
BBCD027	87	BBP019SC	308	BBPARTLOOP024	364	BBT046	260
BBCD029	343	BBP025	298	BBPARTLOOP025	364	BBT048-NL	200, 240
BBCD030	274	BBP043	298	BBPARTLOOP027	364	BBT049	110
BBCD031	187	BBP056-VX	295	BBPARTLOOP029	364	BBT050-NL	45, 182
BBCD033	286	BBP062	216	BBPARTLOOP031	364	BBT051-NL	282
BBCD034	360	BBP064	340	BBPARTLOOP033	364	BBT053	272
BBCD035	126	BBP082	197	BBPARTLOOP034	364	BBT053-NL	272
BBCD037	270	BBPART002	27, 364	BBPARTLOOP037	364	BBT054-NL	56, 69
BBCD038	60	BBPART006	364	BBPARTLOOP038	364	BBT056VX-NL	295
BBCD039	150	BBPART008	364	BBPARTLOOP039	364	BBT057-NL	76, 80
BBCD040	83	BBPART009 L/H	364	BBPARTLOOP040	364	BBT058	101
BBCD041	104	BBPART009 R/H	364	BBPARTLOOP041	364	BBT058-NL	101
BBCD042	203, 210	BBPART010	364	BBPARTLOOP042	364	BBT059-NL	164
BBCD044	78	BBPART011	364	BBPARTLOOP043	364	BBT060-NL	358
BBCD045	166, 167	BBPART012	364	BBPARTLOOP044	364	BBT061-NL	110
BBCD046	260	BBPART013	364	BBPARTLOOP045	364	BBT064-NL	340
BBCD047	343	BBPART014	364	BBPARTLOOP047	365	BBT065-NL	282
BBCD048	200, 240	BBPART015	364	BBPARTLOOP048	365	BBT066-NL	52, 67
BBCD049	110	BBPART017	364	BBPARTLOOP049	365	BBT067-NL	178
BBCD050	45, 182	BBPART018	368	BBPARTLOOP050	365	BBT068-NL	142
BBCD051	282	BBPART019	364	BBPARTLOOP051	365	BBT074-NL	98
BBCD052	120	BBPART020	364	BBPARTLOOP054	365	BBT076-NL	278
BBCD053	272	BBPART021	364	BBPARTLOOP056	365	BBT079-NL	162
BBCD054	56, 69	BBPART022-LH	364	BBPARTLOOP057	365	BBT080-NL	147
BBCD055	52, 56, 67, 69	BBPART022-RH	364	BBPARTLOOP058	365	BBT081-NL	272
BBCD057	76, 80	BBPART023	364	BBR072	350	BHOSE001	301, 306
BBCD058	101	BBPART024	364	BBR073	352	BHOSE002	301, 302, 306

# Product Codes

Part Number	Page	Part Number	Page	Part Number	Page	Part Number	Page
BHOSE003	220, 224, 227, 230, 232	CANFIBRESPARE016	367	CANOPY010-M †	50, 53, 57, 61, 151	CANOPY020-P	101, 104
BHOSE004	221, 225, 231, 233	CANFIBRESPARE019	367	CANOPY010-MG	50, 53, 57, 61, 151	CANOPY021-B	360
BHOSE005	220, 224	CANFIBRESPARE020	367	CANOPY010-P †	50, 53, 57, 61, 151	CANOPY021-P	358, 360
BHOSE009	255	CANFIBRESPARE021	367	CANOPY010-S	50, 53, 57, 61, 151	CANOPY021-W	358, 360
BRACKET100	304	CANFIBRESPARE022	367	CANOPY010-SB †	50, 53, 57, 61, 151	CANOPY022-P	98, 147
CAN001	41	CANFIBRESPARE023	367	CANOPY010-TR	50, 53, 57, 61, 151	CANOPY022-W	98, 147
CANFIBRE048-BS	200, 240	CANFIBRESPARE024	367	CANOPY010-WB	50, 53, 57, 61, 151	CANOPYSPARE001	365
CANFIBRE048-CB	200, 240	CANFIBRESPARE025	367	CANOPY010-WINDOW	366	CANOPYSPARE002	365
CANFIBRE048-HG	200, 240	CANFIBRESPARE026	367	CANOPY011-WINDOW	366	CANOPYSPARE003	365
CANFIBRE048-P	200, 240	CANFIBRESPARE027	367	CANOPY012-WINDOW	366	CANOPYSPARE004	365
CANFIBRE048-PW	200, 240	CANFIBRESPARE028	367	CANOPY013-BS	200, 240	CANOPYSPARE005	365
CANFIBRE048-SG	200, 240	CANFIBRESPARE029	367	CANOPY013-CB	200, 240	CANOPYSPARE006	365
CANFIBRE048-WINDOW	367	CANFIBRESPARE030	367	CANOPY013-PW	200, 240	CANOPYSPARE007	365
CANFIBRE048-WP	200, 240	CANFIBRESPARE031	367	CANOPY013-WP	200, 240	CANOPYSPARE008	365
CANFIBRE050-BM	45, 179, 183	CANFIBRESPARE032	367	CANOPY014-BM	45, 179, 183	CANOPYSPARE009	365
CANFIBRE050-GG	179	CANFIBRESPARE033	367	CANOPY014-CL WINDOW	366	CANOPYSPARE010	365
CANFIBRE050-IB	45, 179, 183	CANFIBRESPARE034	367	CANOPY014-GG	179	CANOPYSPARE012	365
CANFIBRE050-P	45, 179, 183	CANFIBRESPARE035	367	CANOPY014-IB	45, 179, 183	CANOPYSPARE013	365
CANFIBRE050-SS	45, 179, 183	CANFIBRESPARE036	367	CANOPY014-P	45, 179, 183	CANOPYSPARE014	365
CANFIBRE050-TG	45, 183	CANFIBRESPARE037	367	CANOPY014-WINDOW	366	CANOPYSPARE015	365
CANFIBRE050-WINDOW	367	CANFIBRESPARE038	367	CANOPY014-WS	45, 179, 183	CANOPYSPARE016	365
CANFIBRE050-WS	45, 179, 183	CANFIBRESPARE039	367	CANOPY015-AB	278, 283	CANOPYSPARE017	365
CANFIBRE051-AB	279, 283	CANOPY MOUNT KIT 014	365	CANOPY015-BM	278, 283	CANOPYSPARE018	365
CANFIBRE051-DG	279, 283	CANOPY MOUNT KIT 015	365	CANOPY015-CL WINDOW	366	CANOPYSPARE019	365
CANFIBRE051-P	279, 283	CANOPY002A	286	CANOPY015-P †	278, 283	CANOPYSPARE020	365
CANFIBRE051-SM	279, 283	CANOPY002-P	286	CANOPY015-SW †	278, 283	CANOPYSPARE021	365
CANFIBRE051-SW	279, 283	CANOPY003-WINDOW	366	CANOPY015-WINDOW	366	CANOPYSPARE022	365
CANFIBRE051-WINDOW	367	CANOPY004-P	64, 154	CANOPY017-SW	283	CANOPYSPARE023	365
CANFIBRE054-AW	50, 53, 57, 61	CANOPY004-W	64, 154	CANOPY017-WINDOW	367	CANOPYSPARE024	365
CANFIBRE054-BL	50, 53, 57, 61	CANOPY004-WINDOW	366	CANOPY018-B	151	CANOPYSPARE025	365
CANFIBRE054-FW	50, 53, 57, 61, 151	CANOPY005-WINDOW	366	CANOPY018-TF	151	CANOPYSPARE026	365
CANFIBRE054-IS	50, 53, 57, 61	CANOPY006-WINDOW	366	CANOPY019-B	83	CANOPYSPARE027	365
CANFIBRE054-M	50, 53, 57, 61, 151	CANOPY007-WINDOW	366	CANOPY019-BS	83	CANOPYSPARE028	365
CANFIBRE054-P	50, 53, 57, 61, 151	CANOPY008-BM	187	CANOPY019-CL WINDOW	367	CANOPYSPARE029	365
CANFIBRE054-SB	50, 53, 57, 61, 151	CANOPY008-WINDOW	366	CANOPY019-G	80	CANOPYSPARE031	365
CANFIBRE054-WB	50, 53, 57, 61, 151	CANOPY009-WINDOW	366	CANOPY019-MB	80	CANOPYSPARE032	365
CANFIBRE054-WINDOW	367	CANOPY010 BRACKET	50, 53, 57, 61, 151	CANOPY019-NS	80	CANOPYSPARE033	365
CANFIBRE057-WINDOW	367	CANOPY010-AB	50, 53, 57, 61, 151	CANOPY019-P	80, 83	CANOPYSPARE034	365
CANFIBRESPARE006	367	CANOPY010-AM	50, 53, 61, 151	CANOPY019-PB	80	CANOPYSPARE035	365
CANFIBRESPARE007	367	CANOPY010-AW †	50, 53, 57, 61, 151	CANOPY019-S	83	CANOPYSPARE036	365
CANFIBRESPARE010	367	CANOPY010-BL †	50, 53, 57, 61, 151	CANOPY019-SW	80	CANOPYSPARE037	365
CANFIBRESPARE011	367	CANOPY010-CL WINDOW	366	CANOPY019-SW †	83	CANOPYSPARE038	365
CANFIBRESPARE012	367	CANOPY010-CW	50, 53, 57, 61, 151	CANOPY020-B	101	CANOPYSPARE039	365
CANFIBRESPARE013	367	CANOPY010-FW †	50, 53, 57, 61, 151	CANOPY020-CB	101	CANOPYSPARE040	365
CANFIBRESPARE014	367	CANOPY010-G †	50, 53, 57, 61, 151	CANOPY020-CL WINDOW	367	CANOPYSPARE041	365
CANFIBRESPARE015	367	CANOPY010-IS †	50, 53, 57, 61, 151	CANOPY020-GG	101	CANOPYSPARE042	365

# Product Codes

Part Number	Page	Part Number	Page	Part Number	Page	Part Number	Page
CANOPYSPARE043	365	CANOPYSPARE091	366	ET38-1	422	FOR005BKP	55
CANOPYSPARE044	365	CAP001	41	ET38-2	419, 420, 422	FOR005BKPGVM	378
CANOPYSPARE045	365	CAP002	40	ET69	418, 419, 420, 421	FOR005BKPGVM1	378
CANOPYSPARE046	365	CAP003	40	FOR001A	58, 62, 70, 152	FOR005C	54
CANOPYSPARE047	365	CB20	418, 420	FOR001AKF	59, 63, 153	FOR005CKF	55
CANOPYSPARE048	366	CB35	419, 422	FOR001AKG	59, 63, 153	FOR005CKFGVM	378
CANOPYSPARE049	366	CB7	418, 419, 420	FOR001AKP	59, 63, 153	FOR005CKFGVM1	378
CANOPYSPARE050	366	CLINER001	370	FOR001B	58, 62, 70, 152	FOR005CKG	55
CANOPYSPARE051	366	CPLATE001	301, 306	FOR001BKF	59, 63, 153	FOR005CKP	55
CANOPYSPARE052	366	CPLATE003	220, 224, 227, 230, 232	FOR001BKFGVM1	379	FOR005CKPGVM	378
CANOPYSPARE053	366	DB140	31	FOR001BKG	59, 63, 153	FOR005CKPGVM1	378
CANOPYSPARE054	366	DB270	31	FOR001BKP	59, 63, 153	FOR005S	54, 68
CANOPYSPARE055	366	DBLOOM	31	FOR001BKPGVM1	379	FOR007A	51
CANOPYSPARE056	366	DBOX001	301, 306	FOR001C	58, 62, 152	FOR008A	51
CANOPYSPARE057	366	DBOX003	220, 224, 227, 230, 232	FOR001CKF	59, 63, 153	GWM002AKF	94
CANOPYSPARE058	366	DHOSE350	97	FOR001CKFGVM1	379	GWM002AKG	94
CANOPYSPARE059	366	DVD001	41	FOR001CKG	59, 63, 153	GWM002AKP	94
CANOPYSPARE060	366	DVD002	41	FOR001CKP	59, 63, 153	GWM002BKF	94
CANOPYSPARE061	366	DVD003	41	FOR001CKPGVM1	379	GWM002BKG	94
CANOPYSPARE062	366	DVD004	41	FOR001S	58, 62, 70, 152	GWM002BKP	94
CANOPYSPARE063	366	DVD005	41	FOR002A	54, 58, 62, 94, 152	GWM002CKF	94
CANOPYSPARE064	366	DVD006	41	FOR002B	54, 58, 62, 94, 152	GWM002CKG	94
CANOPYSPARE066	366	DVD007	41	FOR002C	54, 58, 62, 94, 152	GWM002CKP	94
CANOPYSPARE068	366	DVD008	41	FOR003B	68, 70	HILFR05	115, 116, 289, 359, 361
CANOPYSPARE069	366	DVD009	41	FOR003BKF	70		46, 58, 62, 70, 77, 79, 81, 84, 86, 94, 95, 99, 102, 105, 107, 111, 129, 142, 148, 152, 161, 163, 165, 174, 180, 184, 188, 191, 198, 199, 201, 202, 204, 205, 211, 213, 217, 236, 241, 265, 266, 271, 273, 275, 280, 284, 287, 296, 299, 341, 344, 346, 349, 351
CANOPYSPARE070	366	ET104	418, 420, 421	FOR003BKF1	68	HILFR05 / HILFR05F	
CANOPYSPARE071	366	ET113	418, 420	FOR003BKG	70		
CANOPYSPARE072	366	ET113-1	418, 419, 420, 422	FOR003BKG1	68		
CANOPYSPARE073	366	ET153	418, 419, 420, 421	FOR003BKP	70		
CANOPYSPARE074	366	ET153-1	418, 419, 420, 421, 422	FOR003BKP1	68		
CANOPYSPARE075	366	ET153-2	418, 420, 421, 422	FOR003C	68, 70		
CANOPYSPARE076	366	ET153-3	419, 420, 422	FOR003CKF	70	HILFR05F	54, 68, 353
CANOPYSPARE077	366	ET154	419, 420, 422	FOR003CKF1	68	HILFR10	115, 116, 289, 359, 361
CANOPYSPARE078	366	ET155	419, 420, 422	FOR003CKG	70		46, 58, 62, 70, 77, 79, 81, 84, 86, 94, 95, 99, 102, 105, 107, 111, 129, 142, 148, 152, 161, 163, 165, 174, 180, 184, 188, 191, 198, 199, 201, 202, 204, 205, 211, 213, 217, 236, 241, 265, 266, 271, 273, 275, 280, 284, 287, 296, 299, 341, 344, 346, 349, 351
CANOPYSPARE079	366	ET158	418, 420	FOR003CKG1	68	HILFR10 / HILFR10F	
CANOPYSPARE080	366	ET158-1	418, 420, 421	FOR003CKP	70		
CANOPYSPARE081	366	ET158-2	419, 420, 422	FOR003CKP1	68		
CANOPYSPARE082	366	ET160	419, 420, 422	FOR005A	54, 68		
CANOPYSPARE083	366	ET17	418, 419, 420, 421, 422, 424	FOR005AKF	55		
CANOPYSPARE084	366	ET174	419, 420	FOR005AKG	55		
CANOPYSPARE085	366	ET175	419	FOR005AKP	55		
CANOPYSPARE086	366	ET176	419	FOR005B	54		
CANOPYSPARE087	366	ET177	419	FOR005BKF	55		
CANOPYSPARE088	366	ET17S	420	FOR005BKFGVM	378		
CANOPYSPARE089	366	ET34	418, 419, 420, 422	FOR005BKFGVM1	378		
CANOPYSPARE090	366	ET38	418, 419, 420, 421, 422	FOR005BKG	55		





# Product Codes

Part Number	Page	Part Number	Page	Part Number	Page	Part Number	Page	
HILFR15 / HILFR15F	46, 58, 62, 70, 77, 79, 81, 84, 86, 94, 95, 99, 102, 105, 107, 111, 129, 142, 148, 152, 161, 163, 165, 174, 180, 184, 188, 191, 198, 199, 201, 202, 204, 205, 211, 213, 217, 236, 241, 265, 266, 271, 273, 275, 280, 284, 287, 296, 299, 341, 344, 346, 349, 351	HOLD008CKG1	75	HOLD021CKF1	82, 103	HOLD022AKF	77, 79	
	HILFR15F	54, 68, 353	HOLD009	72, 75, 112	HOLD021CKF1GVM1	382	HOLD022AKG	77, 79
	HOLD004BD/S	73, 74, 92, 93, 113, 114	HOLD010	88, 90, 109	HOLD021CKF2	143	HOLD022AKP	77, 79
	HOLD004BKF1	93	HOLD020A	77, 79, 81, 84, 99, 102, 105, 111, 142, 148	HOLD021CKF2GVM1	380	HOLD022B	77, 79
	HOLD004BKG1	93	HOLD020B	77, 79, 81, 84, 99, 102, 105, 111, 142, 148	HOLD021CKF3	100, 149	HOLD022BKF	77, 79
	HOLD004BKG2	92	HOLD020BKF	111	HOLD021CKF3GVM	381, 383	HOLD022BKG	77, 79
	HOLD004BNVS	73, 74, 92, 93, 113, 114	HOLD020BKG	111	HOLD021CKF3GVM1	381, 383	HOLD022BKP	77, 79
	HOLD004CD/S	73, 74, 92, 93, 113, 114	HOLD020BKP	111	HOLD021CKFGVM1	380	HOLD022C	77, 79
	HOLD004CKF1	93	HOLD020C	77, 79, 84, 99, 105, 111, 148	HOLD021CKG	85, 106	HOLD022CKF	77, 79
	HOLD004CKG1	93	HOLD020CKF	111	HOLD021CKG1	82, 103	HOLD022CKG	77, 79
	HOLD004CKG2	92	HOLD020CKG	111	HOLD021CKG2	143	HOLD022CKP	77, 79
	HOLD004CN/S	73, 74, 92, 93, 113, 114	HOLD020CKP	111	HOLD021CKG3	100, 149	HOLD022S	77, 79
	HOLD005A	73, 92, 113	HOLD020CKP1	111	HOLD021CKP	85, 106	HOLD022SKF	77, 79
	HOLD005BKF	74, 114	HOLD020S	77, 79, 84, 99, 105, 111, 148	HOLD021CKP1	82, 103	HOLD022SKG	77, 79
	HOLD005BKG	74, 114	HOLD021A	81, 84, 99, 102, 105, 143, 148	HOLD021CKP1GVM1	382	HOLD022SKP	77, 79
HOLD005CKF	74, 114	HOLD021AKF	85, 106	HOLD021CKP2	143	HOLD023B	86, 107	
HOLD005CKG	74, 114	HOLD021AKF1	82, 103	HOLD021CKP2GVM1	380	HOLD023BKG	86, 107	
HOLD006B	88, 90, 109	HOLD021AKF2	143	HOLD021CKP3	100, 149	HOLD023C	86, 107	
HOLD006BKF	88, 90, 109	HOLD021AKF3	100, 149	HOLD021CKP3GVM	381, 383	HOLD023CKG	86, 107	
HOLD006BKG	88, 90, 109	HOLD021AKG	85, 106	HOLD021CKP3GVM1	381, 383	HYUND003B	97	
HOLD006C	88, 90, 109	HOLD021AKG1	82, 103	HOLD021CKPGVM1	380	HYUND003BKG	97	
HOLD006CKF	88, 90, 109	HOLD021AKG2	143	HOLD021D	81, 84, 99, 102, 105, 143, 148	HYUND004	97	
HOLD006CKG	88, 90, 109	HOLD021AKG3	100, 149	HOLD021DKF	85, 106	IAIRFRESHBOX	41	
HOLD006D	88, 90, 109	HOLD021AKP	85, 106	HOLD021DKF1	82, 103	IAP001	204, 205	
HOLD006DKF	88, 90, 109	HOLD021AKP1	82, 103	HOLD021DKF1GVM1	382	IAPKIT	31	
HOLD006DKG	88, 90, 109	HOLD021AKP2	143	HOLD021DKF2	143	IAREALD001	18	
HOLD007	73, 113	HOLD021AKP3	100, 149	HOLD021DKF2GVM1	380	IAREATRIPOD	18	
HOLD007BKF	73, 113	HOLD021B	81, 84, 99, 102, 105, 143, 148	HOLD021DKF3	100, 149	IAWN270L012	24	
HOLD007BKG	73, 113	HOLD021BKF	85, 106	HOLD021DKF3GVM	381, 383	IAWN270L023	24	
HOLD007CKF	73, 113	HOLD021BKF1	82, 103	HOLD021DKF3GVM1	381, 383	IAWN270R012	24	
HOLD007CKG	73, 113	HOLD021BKF2	143	HOLD021DKFGVM1	380	IAWN270R023	24	
HOLD008B	72, 75, 111, 112, 215	HOLD021BKF3	100, 149	HOLD021DKG	85, 106	IAWN270R034	24	
HOLD008BKF	72, 112	HOLD021BKG	85, 106	HOLD021DKG1	82, 103	IAWNING1.4M	26	
HOLD008BKF1	75	HOLD021BKG1	82, 103	HOLD021DKG2	143	IAWNING2.5M	26	
HOLD008BKG	72, 112	HOLD021BKG2	143	HOLD021DKG3	100, 149	IAWNING2.5MRROOM	26	
HOLD008BKG1	75	HOLD021BKG3	100, 149	HOLD021DKP	85, 106	IAWNING2.5MWALL	26	
HOLD008C	72, 75, 111, 112	HOLD021BKP	85, 106	HOLD021DKP1	82, 103	IAWNING2M	26	
HOLD008CKF	72, 112	HOLD021BKP1	82, 103	HOLD021DKP1GVM1	382	IAWNING2MRROOM	26	
HOLD008CKF1	75	HOLD021BKP2	143	HOLD021DKP2	143	IAWNING2MWALL	26	
HOLD008CKG	72, 112	HOLD021BKP3	100, 149	HOLD021DKP2GVM1	380	IAWNINGPART001	369	
		HOLD021C	81, 84, 99, 102, 105, 143, 148	HOLD021DKP3	100, 149	IAWNINGPART002	369	
		HOLD021CKF	85, 106	HOLD021DKP3GVM	381, 383	IAWNINGPART003	369	
				HOLD021DKP3GVM1	381, 383	IAWNINGPART004	369	
				HOLD021DKPGVM1	380	IAWNINGPART005	369	
				HOLD022A	77, 79	IAWNINGPART006	18, 369	

# Product Codes

Part Number	Page	Part Number	Page	Part Number	Page	Part Number	Page
IAWNINGPART007	369	ICAMBER14	169, 214, 251, 261	ICANOPY082-WINDOW	367	ICSC042R	203
IAWNINGPART008	369	ICANOPY048-BS	200, 240	ICANOPY082-WP	197	ICSC043F	295, 298
IAWNINGPART009	26, 369	ICANOPY048-CB	200, 240	ICANOPYSPARE001	367	ICSC043R	295, 298
IAWNINGPART010	369	ICANOPY048-P	200, 240	ICANOPYSPARE002	367	ICSC047F	340, 343
IAWNINGQR	26	ICANOPY048-PW	200, 240	ICANOPYSPARE003	367	ICSC047R	340, 343
IAWNINGQR HOOK	26	ICANOPY048-SG	200, 240	ICANOPYSPARE004	367	ICSC048F	200
IAWNINGSPARE001	368	ICANOPY048-WINDOW	367	ICANOPYSPARE005	367	ICSC048MYR	200
IAWNINGSPARE002	368	ICANOPY048-WP	200, 240	ICANOPYSPARE006	367	ICSC048R	200
IAWNINGSPARE003	368	ICANOPY050-BM	45, 179, 183	ICANOPYSPARE007	367	ICSC049R	76, 78, 110
IAWNINGSPARE004	368	ICANOPY050-GG	45, 179, 183	ICANOPYSPARE008	367	ICSC050F	179, 183
IAWNINGSPARE005	369	ICANOPY050-IB	45, 179, 183	ICANOPYSPARE009	367	ICSC050R	179, 183
IAWNINGSPARE006	369	ICANOPY050-P	45, 179, 183	ICANOPYSPARE010	367	ICSC051F	279, 283
IAWNINGSPARE007	369	ICANOPY050-SS	45, 179, 183	ICANOPYSPARE011	367	ICSC051R	279, 283
IAWNINGSPARE008	369	ICANOPY050-TG	45, 179, 183	ICANOPYSPARE013	368	ICSC053F	272
IAWNINGSPARE009	369	ICANOPY050-WINDOW	367	ICANOPYSPARE014	368	ICSC053R	272
IAWNINGSPARE010	369	ICANOPY050-WS	45, 179, 183	ICANOPYSPARE015	368	ICSC054F	53, 57, 67, 69, 151
IAWNINGSPARE011	369	ICANOPY051-AB	279, 283	ICANOPYSPARE016	368	ICSC054R	67, 69
IAWNINGSPARE012	369	ICANOPY051-DG	279, 283	ICARGOBAG001	36	ICSC055R	50, 53, 57, 151
IAWNINGSPARE013	369	ICANOPY051-P	279, 283	ICHAIR0034	14	ICSC059F	162, 164
IAWNINGSPARE014	369	ICANOPY051-SM	279, 283	ICHAIR0045	14	ICSC059R	162, 164
IAWNLED270012	25	ICANOPY051-SW	279, 283	ICHAIR0056	14	ICSC060F	358, 360
IAWNORG012	25	ICANOPY051-WINDOW	367	ICHAIR0067	14	ICSC060R	358, 360
IAWNWALL27012	25	ICANOPY054-AM	50, 53, 57, 61, 151	ICHAIRHA004	14	ICSC069F	50
IAWNWALL27023	25	ICANOPY054-AW	50, 53, 57, 61, 151	ICHAIRL003	14	ICSC070F	254
IAWNWALL27034	25	ICANOPY054-BL	50, 53, 57, 61, 151	ICHAIRMS	14	ICSC070R	254
IAWNWALL27045	25	ICANOPY054-FW	50, 53, 57, 61, 151	ICHAIRSA005	14	ICSC074F	98, 147
IAXE001	17	ICANOPY054-G	50, 53, 57, 61, 151	ICOMPRESSOR AIR LINE	372	ICSC074R	98, 147
IAXE002	17	ICANOPY054-P	50, 53, 57, 61, 151	ICOMPRESSOR003	12	ICSC082F	197
IBATISO	39	ICANOPY054-SB	50, 53, 57, 61, 151	ICOMPRESSOR004	12	ICSC082R	197
IBATTBOX0012	19	ICANOPY054-WINDOW	367	ICR003	221, 225, 231, 233	ICSCLOAD	96
IBIN0012	17	ICANOPY060-P	358, 360	ICSC011F	218	IDBM001	31
IBLOCK	11	ICANOPY060-W	358, 360	ICSC011F3/4	218	IDCDC40	31
IBOOK001	41	ICANOPY060-WINDOW	367	ICSC011R	218	IDCDCSA	31
IBOTTLE001	41	ICANOPY074-B	98	ICSC019F	308, 311, 315, 323	IDCDCSOLAR	31
IBOTTLE002	41	ICANOPY074-GG	98	ICSC019F3/4	308, 311, 315	IDD100	304
IBOW	11	ICANOPY074-OG	98	ICSC019R	311, 323		12, 45, 50, 53, 57, 61, 64, 67, 69, 76, 78, 80, 83, 87, 89, 91, 98, 101, 104, 108, 110, 118, 120, 126, 133, 138, 142, 147, 151, 154, 162, 164, 166, 167, 179, 183, 187, 190, 197, 200, 203, 206, 210, 216, 218, 219, 228, 240, 243, 248, 254, 256, 260, 264, 270, 272, 274, 279, 283, 286, 290, 295, 298, 300, 303, 305, 308, 311, 315, 319, 323, 326, 332, 340, 343, 346, 348, 350, 352, 358, 360
IBTBAGS	16	ICANOPY074-P	98	ICSC019SCF	308		
IBTRAY050	45, 178, 182	ICANOPY074-S	98	ICSC031F	187, 190		
IBTRAY054	50, 52, 56, 60, 150	ICANOPY074-W	98	ICSC031R	187, 190		
IBTRAY056	295	ICANOPY074-WINDOW	367	ICSC033F	286		
IBTRAY057	80	ICANOPY082-B	197	ICSC033R	286		
IBTRAY064	340, 343	ICANOPY082-BS	197	ICSC038F	61, 151		
IBTRAYTUB	31	ICANOPY082-P	197	ICSC038R	61, 151		
IBUCKET0012	17	ICANOPY082-SG	197	ICSC040F	76, 78, 80, 83, 101, 104, 110		
IBUSHTOILET	16	ICANOPY082-SW	197	ICSC040R	80, 83, 101, 104		
ICAMBER12	44, 237, 242, 262, 263	ICANOPY082-TG	197	ICSC042F	203		



# Product Codes

Part Number	Page	Part Number	Page	Part Number	Page	Part Number	Page
IDM009	255	IFRIDGESPARE004	368	ILBDR003B	28	ILED80SPAREBKTS	368
IDOC003	221, 225, 231, 233	IFRIDGESPARE005	368	ILBDRSPAREBKTS	368	ILED9C	27
IDRAG	11	IFRIDGESPARE006	368	ILBSR000B	28	ILED9M	27
IDUFBAG001	36	IFRIDGESPARE007	368	ILBSR001	29	ILEDBLAST2C	27
IEBC001	31	IFRIDGESPARE008	368	ILBSR001B	28	ILEDBLAST2MOUNT	368
IENSUITE	26	IFRIDGESPARE009	368	ILBSR001BW	28	ILEDBLAST2S	27
IEX019DPF	311	IFRIDGESPARE010	368	ILBSR001C	29	ILEDBLASTMOUNT	368
IEX039	150	IFRIDGESPARE011	368	ILBSR002	29	ILEDCOMETMOUNT	368
IEX048	200, 240	IFRIDGESPARE012	368	ILBSR002B	28	ILEDCOSMO	30
IEX051	278, 282	IFRIDGESPARE013	368	ILBSR002BW	28	ILEDDIMMER	18
IEX056	295	IFRIDGESPARE014	368	ILBSR002C	29	ILEDSB	30
IEX057	80	IFRIDGESPARE015	368	ILBSR003	29	ILEDSTRIP	18
IEX058	101	IFRIDGESPARE016	368	ILBSR003B	28, 118, 124, 126	ILEDUNI3	30
IEX060	358	IFRIDGESPARE017	368	ILBSR003BW	28, 264	ILEDUNI5	30
IEX064	340, 343	IFRIDGESPARE018	368	ILBSR003C	29	ILEDWL10	30, 350, 352
IEX067	45, 178, 182	IFRIDGESPARE019	368	ILBSR004	29	ILEDWL10FA	30, 350, 352
IEX069	50	IFRIDGESPARE020	368	ILBSR005B	28	ILEDWLC	18
IEXH4075	253, 372	IFRIDGESPARE021	368	ILBSRSPAREBKTS	368	IMALLET	17
IEXHAUST002	323	IFRIDGESPARE022	368	ILBSRWSPAREBKTS	368	IMAZ001B	356, 357
IEXHAUST006	218, 219	IFRIDGESPARE023	368	ILC7AMBER	29	IMAZ001BKF	356
IEXHAUST009	315	IFRIDGESPARE024	368	ILC7BLACK	29	IMAZ001BKF1	357
IEXHAUST011	206	IFRIDGESPARE025	368	ILC7BLUE	29	IMAZ001BKG	356
IEXHAUST012	203	IFRIDGESPARE026	368	ILC7CLEAR	29	IMAZ001BKG1	357
IEXHAUST013	311	IFRIDGESPARE027	368	ILC9AMBER	29	IMAZ002B	356, 357
IEXHAUST014	64, 154	IFRIDGESPARE028	368	ILC9BLACK	29	IMC001	34
IEXHAUST015	64, 154	IFRIDGESTAND001	21	ILC9BLUE	29	IMC002	34
IEXHAUST017	83	IGLOVES	11	ILC9CLEAR	29	IMC003	34
IEXHAUST019	187	IHCLEAN	17	ILCB7AMBER	29	IMC004	34
IFIRE EXTINGUISHER	39	IHCLEANBOX	17	ILCB7BLACK	29	IMC005	34
IFRIDGE 65 74 BAG	21	IHEADLAMP002	18	ILCB7BLUE	29	IMC006	34
IFRIDGE STRAPS	21	IHIDBULB	368	ILCB7CLEAR	29	IMCAPRIBN07	40
IFRIDGE30	20	IHIGHLIFT001	12	ILED180F	29	IMCAPRIBN09	40
IFRIDGE30 BAG	21	IHIGHLIFT002	12	ILED180S	29	IMCAPRIBN10	40
IFRIDGE40	20	IHIGHLIFT003	12	ILED20B	30, 118, 124, 264, 350, 352	IMCOOPBN05	40
IFRIDGE40 BAG	21	IHIGHLIFT004	12	ILED20BA	30, 118, 124, 264, 350, 352	IMCOOPBN08	40
IFRIDGE50	20	IHOOK BOW	11	ILED20BF	30, 118, 124, 264, 350, 352	IMCOOPBN09	40
IFRIDGE50 BAG	21	IHVFLAG	13, 39	ILED20BFA	30, 118, 124, 264, 350, 352	IMCOOPBN10	40
IFRIDGE65	20	IKETTLE001	17	ILED20BFR	30, 118, 124, 264, 350, 352	IMEGATOM	27
IFRIDGE74	20	ILANTERN001	18	ILED20SPAREBKTS	368	IMTS001M2XL	40
IFRIDGESLIDE001	21, 32	ILANTERN002	18	ILED5X7	27	IMTS001M3XL	40
IFRIDGESLIDE002	21, 32	ILANTERN003	18	ILED7C	27	IMTS001M5XL	40
IFRIDGESLIDE023	21, 32	ILANTERN004	18	ILED7M	27	IMTS001ML	40
IFRIDGESLIDE045	21, 32	ILBDR001B	28	ILED80B	30, 118, 124, 126, 350, 352	IMTS001MM	40
IFRIDGESPARE001	368	ILBDR001BM	28	ILED80BA	30, 118, 124, 126, 350, 352	IMTS001MS	40
IFRIDGESPARE002	368	ILBDR002B	28, 350, 352	ILED80BF	30, 118, 124, 126, 350, 352	IMTS001MXL	40
IFRIDGESPARE003	368	ILBDR002BM	28, 350, 352	ILED80BFA	30, 118, 124, 126, 350, 352	IMTS001WL	40

# Product Codes

Part Number	Page
IMTS001WM	40
IMTS001WS	40
IMTS001WXL	40
IMTS002M2XL	40
IMTS002M3XL	40
IMTS002M5XL	40
IMTS002ML	40
IMTS002MM	40
IMTS002MS	40
IMTS002MXL	40
INUMBPLATE	41
INUMBPLATESLIM	41
IOVEN0012	17
IPET0023	14
IPL048	31, 200
IPL050	31, 182
IPL056	31, 295
IPL057	31, 76, 80, 83
IPL058	31, 101, 104, 110
IPL060	31, 358, 360
IPL066	31, 52, 56, 60, 67, 69
IPL067	31, 178
IPL070	31, 254
IPL074	98, 147
IPL077	31, 118, 124
IPOWER0012	19
IPOWER0023	19
IPOWER0034	19
IQFS001	15
IQFSTEP	16
IRECBRDBASE	13
IRECBRDGREEN	13
IRECBRDGREY	13
IRECBRDLEASH	13
IRECBRDPINS115	13
IRECBRDSAND	13
IRECKIT001 BAG	11
IRECKIT002 BAG	11
IRECKIT003	10
IRECKIT004	10
IREVERSECAM001	39
IRL120B	30
IRLB200	36
IRLB250	36
IRLB350	36
IRLB500	36

Part Number	Page
IRLB600	36
IROOFTENT ANNEX	22
IROOFTENT TENT	22
IROOFTENT002	22
IROOFTENT003	22
IROOFTENTSPARE001	369
IROOFTENTSPARE002	369
IROOFTENTSPARE003	369
IROOFTENTSPARE004	369
IROOFTENTSPARE005	369
IROOFTENTSPARE006	369
IROOFTENTSPARE007	369
IROOFTENTSPARE008	369
IROOFTENTSPARE010	369
IROOFTENTSPARE011	369
IROOFTENTSPARE012	369
IROOFTENTSPARE013	369
IROOFTENTSPARE014	369
IROOFTENTSPARE015	369
IROOFTENTSPARE016	369
IROOFTENTSPARE017	369
IROOFTENTSPARE018	369
IROOFTENTSPARE019	369
IROOFTENTSPARE020	369
IRP005	200, 203, 218, 219, 300, 303, 305
IRP019	308, 311, 315, 323
IRP019SC	308
IRP033	286
IRP050	45, 182
IRP051	272, 278, 282
IRP054	52, 56, 60, 67, 69, 150
IRP056	295, 298
IRP057	76, 80
IRP058	76, 78, 80, 83, 101, 104, 110
IRP059	162, 164, 178
IRP064	340, 343
IRP070	254
IRP074	98
IRP082	197
IRRCAGE14	38, 133, 218, 219, 228, 305, 311, 315, 319, 323, 332
IRRCAGE14-ALLOY	37, 133, 218, 219, 228, 254, 305, 311, 315, 319, 323, 332

Part Number	Page
IRRCAGE18	38, 76, 78, 110, 133, 218, 219, 228, 295, 298, 300, 303, 305, 311, 315, 319, 323, 332, 340, 343, 346, 348
IRRCAGE18-ALLOY	37, 76, 78, 110, 133, 218, 219, 228, 295, 298, 300, 303, 305, 311, 315, 319, 323, 332, 340, 343, 346, 348
IRRCAGE22	38, 133, 218, 219, 228, 298, 305, 315, 319, 323, 332
IRRCAGE22-ALLOY	37, 133, 218, 219, 228, 298, 305, 315, 319, 323, 332
IRRCROSSBAR001	37, 368
IRREXT1085	37
IRRFEET001	38, 76, 78
IRRFEET100	38, 218, 219, 254
IRRFEET125	38, 218, 219, 228, 305, 311, 323, 332, 348
IRRFEET150	38
IRRFEET210	38, 133, 228, 315, 319
IRRFEETABS14	38, 50, 53, 57, 61, 80, 83, 98, 101, 104, 147, 151, 179, 183, 200, 278, 283
IRRFEETLC100	38, 300, 303
IRRFEETLC200	38, 295, 298, 346
IRRFEETMUX	38, 110
IRRFEETPRADO150	38, 340, 343
IRROPEN14-ALLOY	37, 133, 218, 219, 228, 254, 311, 315, 319, 332
IRRTENT18	38, 76, 78, 110, 133, 218, 219, 228, 295, 298, 300, 303, 305, 311, 315, 319, 323, 332, 340, 343, 346, 348
IRRTENT22	38, 133, 218, 219, 228, 298, 305, 315, 319, 323, 332
IRRTFLAT18-ALLOY	37, 76, 78, 110, 133, 218, 219, 228, 295, 298, 300, 303, 305, 311, 315, 319, 323, 332, 340, 343, 346, 348
IRRTRADE18	37, 76, 78, 110, 133, 218, 219, 228, 295, 298, 300, 303, 305, 311, 315, 319, 323, 332, 340, 343, 346, 348
IRRTRADE18-ALLOY	37, 76, 78, 110, 133, 218, 219, 228, 295, 298, 300, 303, 305, 311, 315, 319, 323, 332, 340, 343, 346, 348
IRRTRADE22	38, 133, 218, 219, 228, 298, 305, 315, 319, 323, 332
IRRTRADE22-ALLOY	37, 133, 218, 219, 228, 298, 305, 315, 319, 323, 332
IRRWHEELCLAMP	38, 368
IRTT0012	22

Part Number	Page
IRTT0023	22
IRTTAWN0023	22
IRWB001	13
ISAFETYTRI	39
ISB200F	296, 299
ISB200R	296, 299
ISB600F	217
ISB600R	217
ISB789F	309, 316, 320
ISB789FW	309, 312, 316, 320, 324
ISB789FWP	309, 312, 316, 320, 324
ISB789RW	310, 313, 317, 321, 325
ISB80F	280, 284
ISBB20033R	370
ISBB20038R	370
ISBB200REB	370
ISBB60027R	370
ISBB60036R	370
ISBB78930R	370
ISBB78933R	370
ISBB789DB	370
ISBB789RBK	370
ISBB789REB	370
ISBB8033R	370
ISD1000	32, 133, 218, 219, 228, 295, 298, 300, 303, 305, 332
ISD1300	32, 45, 50, 52, 56, 60, 64, 80, 83, 87, 89, 91, 98, 101, 104, 108, 147, 150, 154, 178, 182, 187, 190, 200, 203, 206, 240, 278, 282, 286, 290, 315, 319, 326, 358, 360
ISD900	32, 138, 323, 340, 343, 346, 348
ISEAT COVER	13
ISHOVEL001	17
ISHOWER001	16
ISHOWER002	16
ISHOWER003	16
ISHOWER004	16
ISL6010	47, 54, 58, 62, 65, 66, 73, 74, 81, 84, 86, 88, 90, 92, 93, 94, 99, 102, 105, 107, 109, 113, 114, 129, 143, 148, 152, 155, 157, 181, 185, 199, 202, 204, 205, 207, 208, 209, 234, 235, 236, 268, 277, 280, 284, 287, 289, 291, 292, 293, 351
ISLIDEAWAY048-E	200



# Product Codes

Part Number	Page	Part Number	Page	Part Number	Page	Part Number	Page
ISLIDEAWAY051-E	279, 283	ISNORKEL021	64	ISTORE0023	17	ITDW012	218, 219
ISLIDEAWAY054-E	50, 53, 57, 61	ISNORKEL022	89, 108	ISWAG001	15	ITDW013	332
ISLIDEAWAY060-E	358, 360	ISNORKEL023	308, 211, 315, 323	ISWAG002	15	ITDW015	305
ISLIDEAWAY067-E	179, 183	ISNORKEL024	154	ISWAG0023	15	ITDW016	305
ISLIDEAWAY072L-E	350	ISNORKEL028	87	ISWAG0034	15	ITDW017	303
ISLIDEAWAY072S-E	350	ISNORKEL032	126	ISWAGBAG	15	ITDW018	300, 303
ISLIDEAWAY073L-E	352	ISNORKEL034	52, 56, 60	ISWAGPART001	371	ITDW019	303
ISLIDEAWAY073S-E	352	ISNORKEL034XLT	52, 56, 60	ISWAGPART002	371	ITDW020	295, 298
ISLIDEAWAY074-E	98	ISNORKEL035	343	ISWAGSPARE001	371	ITDW022	315
ISLIDEAWAY075-E	49, 238, 239	ISNORKEL036	76, 78, 80, 83	ISWAGSPARE002	371	ITDW023	290
ISLIDEAWAY075RB-E	49, 238, 239	ISNORKEL037	358, 360	ITABLE0012	14	ITDW024	286
ISLIDEAWAY077-E	118	ISNORKEL041	101, 104, 110	ITABLE0023	14	ITDW025	206
ISLIDEAWAY080-E	147	ISNORKEL048	200	ITB001	35	ITDW026	206
ISLIDEAWAY082-E	197	ISNORKEL050	45, 182	ITB002	35	ITDW028	203
ISLIDEAWAY087L-E	71	ISNORKEL051	278, 282	ITB003	35	ITDW029	203
ISLIDEAWAY087S-E	71	ISNORKEL053	272	ITB004	35	ITDW031	190
ISLIDESPAREBADGE	369	ISNORKEL056	295	ITB005	35	ITDW032	187
ISLIDESPAREBKT100	369	ISNORKEL064	340	ITB006	35	ITDW037	50, 52, 56, 60, 150
ISLIDESPAREBKT115	369	ISNORKEL067	178	ITB007	35	ITDW038	80, 83, 101, 104
ISLIDESPAREBKT45	369	ISNORKEL070	254	ITB009	35	ITDW040	360
ISLIDESPAREBKT70	369	ISNORKEL074	98	ITBL038	60	ITDW048	200, 240
ISLIDESPAREBKT80	369	ISNORKEL076N	278	ITBL039	60, 150	ITDW050	45, 178, 182
ISLIDESPARECLUTCH	369	ISNORKEL080	147	ITBL040	80, 83	ITDW051	278, 282
ISLIDESPAREECU	369	ISNORKELSPARE001	370	ITBL041	101, 104	ITDW060	358
ISLIDESPAREFSTR	369	ISNORKELSPARE002	370	ITBL048	200, 240	ITDW064	340, 343
ISLIDESPARELIGHT	369	ISOFSHA001	11	ITBL050	45, 182	ITDW074	98, 147
ISLIDESPAREMOTOR	369	ISOFSHA002	11	ITBL051	282	ITENTBAG001	22, 36
ISLIDESPAREREMOTE	369	ISOLAR120	19	ITBL054	52, 56	ITENTFAN002	18
ISNATCH005	11	ISOLAR200	19	ITBL060	358, 360	ITENTFAN003	18
ISNATCH006	11	ISPEEDY	12	ITBL067	178	ITENTLIGHT002	18
ISNATCHROPE	11		95, 129, 265, 266, 271, 273, 275, 280, 284, 287, 341, 344, 346, 351	ITBL074	98, 147	ITOILET12	16
ISNORKEL 3.5" HAT	370	ISST001		ITBL076	278	ITOILETA+B	16
ISNORKEL 3" HAT	370	ISST004	296, 299	ITBL082	197	ITOW	11
ISNORKEL 4" HAT	370	ISST005	353	ITD1000	32, 133, 218, 219, 228, 295, 298, 300, 303, 305, 332	ITRACK305	13
ISNORKEL001	286	ISST007	161, 198, 199, 201, 202, 204, 205, 211, 213, 236, 241		32, 45, 50, 52, 56, 60, 64, 80, 83, 87, 89, 91, 98, 101, 104, 108, 147, 150, 154, 178, 182, 187, 190, 200, 203, 206, 240, 278, 282, 286, 290, 315, 319, 326, 358, 360	ITRACK610	13
ISNORKEL003	300, 303	ISST010	46, 163, 165, 174, 180, 184, 188, 191	ITD1300		ITRACKRING	13
ISNORKEL004	305	ISST014	58, 62, 70, 152			ITREDS1100	13
ISNORKEL005	348	ISST017	77, 79, 81, 84, 99, 102, 105, 111, 142, 148	ITD900	32, 138, 323, 340, 343, 346, 348	ITREE	11
ISNORKEL006	346	ISST052	121	ITDFK064	340, 343	ITSS021	102, 105
ISNORKEL009	308, 319, 326	ISST055	54, 68	ITDW004	348	ITUB0012	17
ISNORKEL010	298	ISST075	238, 239	ITDW009	323	ITYRE001	12
ISNORKEL011	228	ISST083	94	ITDW011	218, 219	ITYRE002	12
ISNORKEL013	218	ISTORE0012	17			ITYRE004	12
ISNORKEL015	219					ITYRE005	12
ISNORKEL019	203, 210					ITYRE006	12
ISNORKEL020	187, 190					ITYRE007	12



# Product Codes

Part Number	Page	Part Number	Page	Part Number	Page	Part Number	Page
IYRE008	12	JEEP003BKG	117	JEEP030BKP	125	LAND009BKF	136, 137, 141
IUP001K	286	JEEP004BD/S	117	JEEP030C	125	LAND009BKG	136, 137, 141
IUP002K	346	JEEP004BN/S	117	JEEP030CKG	125	LAND009BKP	136, 137, 141
IUP003F	340, 343	JEEP006B	123	JEEP030CKP	125	LAND009CKF	136, 137, 141
IUP003K	270, 340, 343	JEEP006BKG	123	JEEP031B	119	LAND009CKG	136, 137, 141
IUP004F	298	JEEP006CKG	123	JEEP032B	119	LAND009CKP	136, 137, 141
IUP004K	298	JEEP007B	128	JEEP032BKP	119	LAND011B	136, 137, 140, 141
IUP006K	206	JEEP007BKG	128	JEEP032C	119	LAND011C	136, 137, 140, 141
IUP007E	210	JEEP008B	128	JEEP032CKP	119	LAND014B	134, 135, 140
IUP007F	203	JEEP012B	122	JEEP032D	119	LAND014BKF	140
IUP007K	203	JEEP012BKG	122	JEEP032DKP	119	LAND014BKG	140
IUP008K	64, 154	JEEP012C	122	JKBKITL	127	LAND014CKF	140
IUP009K	87, 89, 91, 108	JEEP013B	122	JMC002B	129	LAND014CKG	140
IUP010F	190	JEEP013C	122	JMC002BKF	129	LAND019B	139
IUP010K	190	JEEP014B	116	JMC002BKG	129	LAND019C	139
IUP011K	260	JEEP014BKG	116	JMC002BKP	129	LAND020B	139
IUP012K	360	JEEP014BKG1	116	JMC002C	129	LAND020C	139
IUP013K	166, 167	JEEP014C	116	JMC002CKF	129	LC70F30	309, 312, 316, 320, 324, 330
IUP014F	56, 60, 150	JEEP015B	116	JMC002CKG	129	LCF20	266, 301, 306, 349
IUP014K	56, 60, 69, 150	JEEP016B	117, 123	JMC002CKP	129	LCF30	266, 301, 306, 349
IUP015K	218, 219	JEEP017AKG	127	KEY001	41	LCPR20	265, 341, 344
IUP016K	138	JEEP017AKP	127	KEY002	41	LCPR25	265, 341, 344
IUP050K	45, 178, 182	JEEP017B	127	KIA006B	130	LCR15	302, 307
IWC6T	39	JEEP017BKG	127	KIA007B	130	LCR30	302, 307
IWEDGE04	370	JEEP017BKP	127	LADA001B	131		129, 143, 199, 202, 204, 205, 209, 236, 268, 280, 284, 287, 289, 291, 292, 293
IWEDGE08	370	JEEP017C	127	LADA002B	131	LP2	
IWEDGE10	370	JEEP018A	127	LAND005BKF	134		47, 54, 58, 62, 65, 66, 73, 74, 92, 93, 94, 113, 114, 152, 155, 157, 207, 208, 234, 235, 277, 351, 353
IWEDGE12	370	JEEP018B	127	LAND005BKG	134	LP3	
IWFT001	21	JEEP019B	127	LAND005BKP	134	LP3-1	427
IWHL001	31	JEEP019BKGL	127	LAND006B	134, 135	LP3-2	427
IWHL002	31	JEEP019BKPL	127	LAND006BKF	134		144, 171, 173, 176, 189, 191, 193, 194, 195, 227, 229, 325, 327, 331, 333, 335, 336, 337, 338, 339, 359, 361
IWHL003	31	JEEP020B	127	LAND006BKG	134	LP4	
IWHL004	31	JEEP025B	121	LAND006BKP	134	LP4-1	427
IWINCHEXT	11	JEEP025BKG	121	LAND006C	134, 135	LP4-2	427
IWP0023	33	JEEP025C	121	LAND006CKF	134	LP5	259
IWT001	33	JEEP025CKG	121	LAND006CKG	134	LP5-1	427
IWT002	33	JEEP026B	121	LAND006CKP	134	LP5-2	427
IWT003	33	JEEP026C	121	LAND007B	134, 135, 137, 141	LP7-1	427
IWT004	33	JEEP029A	125	LAND007BKF	135	LP7-2	427
IWT005	33	JEEP029B	125	LAND007BKG	135	LP9	310, 313, 317, 321
IWT006	33	JEEP029C	125	LAND007BKP	135	LP9-1	427
IWT007	33	JEEP030A	125	LAND007CKF	135	LP9-2	427
IWT008	33	JEEP030AKG	125	LAND007CKG	135	LR12V10W	80
IWTHOSE	33	JEEP030AKP	125	LAND007CKP	135		
JEEP003B	123, 128	JEEP030B	125	LAND008B	134		
JEEP003BKF	117	JEEP030BKG	125	LAND009B	134, 135, 136, 137, 140, 141		



# Product Codes

Part Number	Page	Part Number	Page	Part Number	Page	Part Number	Page
LR12V21W	98, 178, 364	MERC020B	158	MITSO22B	170, 172, 175	MITSO42BKG	174
LTA001	302, 306	MERC021B	158	MITSO22BKF	175	MITSO42BKG1	163, 165
LTA003	221, 225, 231, 233, 304	MERC021BKF	158	MITSO22BKF1	172	MITSO42C	163, 165, 174
LTA200	296, 299	MERC021BKG	158	MITSO22BKF2	170	MITSO42CKF	174
MAH001	144, 145	MINING001	39	MITSO22BKG	175	MITSO42CKF1	163, 165
MAH002B	144	MINING005	39	MITSO22BKG1	172	MITSO42CKG	174
MAH002BKG	144	MINING008	39	MITSO22BKG2	170	MITSO42CKG1	163, 165
MAH003B	145	MITSO13	170, 171, 172, 173, 195	MITSO25B	177	MITSO42S	174
MAH003BKG	145	MITSO15BKF	194	MITSO31	177	MITSO42SKF	174
MAZDA005	65, 66, 74, 93, 114, 155, 157	MITSO15BKF1	193	MITSO31BKG	177	MITSO42SKG	174
MAZDA006A	66, 157	MITSO15BKG	194	MITSO31BKG1	177	MITSO45B	46, 163, 165, 180, 184, 188, 191
MAZDA006AKF	66, 157	MITSO15BKG1	193	MITSO34B	169	MITSO45C	46, 163, 165, 180, 184, 188, 191
MAZDA006AKG	66, 157	MITSO15C	193, 194	MITSO35B	169	MITSO47A	47, 181, 185
MAZDA006AKP	66, 157	MITSO15CKF	194	MITSO38AKG	168	MITSO47AKF	47, 181, 185
MAZDA006B	66, 157	MITSO15CKF1	193	MITSO38B	168	MITSO47AKG	47, 181, 185
MAZDA006BKF	66, 157	MITSO15CKG	194	MITSO38BKG	168	MITSO47B	47, 181, 185
MAZDA006BKG	66, 157	MITSO15CKG1	193	MITSO38C	168	MITSO47BKF	47, 181, 185
MAZDA006BKP	66, 157	MITSO18B	171, 173, 176, 193, 194, 195	MITSO38CKG	168	MITSO47BKG	47, 181, 185
MAZDA006C	66, 157	MITSO18BKF	176	MITSO38CKG1	168	MITSO47BKP	47, 181, 185
MAZDA006CKF	66, 157	MITSO18BKF1	173, 195	MITSO38CKG2	168	MITSO47C	47, 181, 185
MAZDA006CKG	66, 157	MITSO18BKF2	171	MITSO39A	168	MITSO47CKF	47, 181, 185
MAZDA006CKP	66, 157	MITSO18BKG	176	MITSO39B	168	MITSO47CKG	47, 181, 185
MAZDA006D	66, 157	MITSO18BKG1	173, 195	MITSO39C	168	MITSO47CKP	47, 181, 185
MAZDA006DKF	66, 157	MITSO18BKG2	171	MITSO40A	46, 174, 180, 184, 188, 191	NAVR20	161, 198, 201, 241
MAZDA006DKG	66, 157	MITSO18C	171, 173, 176, 193, 194, 195	MITSO40B	46, 163, 165, 174, 180, 184, 188, 191	NISS003BD/S	235
MAZDA006DKP	66, 157	MITSO18CKF	176	MITSO40C	46, 163, 165, 174, 180, 184, 188, 191	NISS003BKG	235
MAZDA014	66, 157	MITSO18CKF1	173, 195	MITSO40S	46, 174, 180, 184, 188, 191	NISS003BN/S	235
MAZDA041A	65, 155	MITSO18CKF2	171	MITSO41A	189, 191	NISS004BD/S	234, 235
MAZDA041AKF	65, 155	MITSO18CKG	176	MITSO41AKF	189, 192	NISS004BN/S	234, 235
MAZDA041AKG	65, 155	MITSO18CKG1	173, 195	MITSO41AKG	189, 192	NISS005BD/S	234
MAZDA041AKP	65, 155	MITSO18CKG2	171	MITSO41B	189, 191	NISS005BKG	234
MAZDA041B	65, 155	MITSO19	170, 171, 172, 173, 175, 176	MITSO41BKF	189, 192	NISS005BN/S	234
MAZDA041BKF	65, 155	MITSO20B	163, 165, 170, 172, 175	MITSO41BKG	189, 192	NISS007B	232
MAZDA041BKG	65, 155	MITSO20BKF	175	MITSO41BKP	189, 192	NISS007BKF	233
MAZDA041BKP	65, 155	MITSO20BKF1	172	MITSO41C	189, 191	NISS007BKG	233
MAZDA041C	65, 155	MITSO20BKF2	170	MITSO41CKF	189, 192	NISS007BKP	233
MAZDA041CKF	65, 155	MITSO20BKG	175	MITSO41CKG	189, 192	NISS008B	233
MAZDA041CKG	65, 155	MITSO20BKG1	172	MITSO41CKP	189, 192	NISS009B	230, 232
MAZDA041CKP	65, 155	MITSO20BKG2	170	MITSO42A	163, 165, 174	NISS009BKF	231, 233
MAZDA041D	65, 155	MITSO20C	170, 172, 175	MITSO42AKF	174	NISS009BKF1	233
MAZDA041DKF	65, 155	MITSO20CKF	175	MITSO42AKG	174	NISS009BKG	231, 233
MAZDA041DKG	65, 155	MITSO20CKF1	172	MITSO42B	163, 165, 174	NISS009BKG1	233
MAZDA041DKP	65, 155	MITSO20CKF2	170	MITSO42BKF	174	NISS009BKP	231, 233
MERC015B	159	MITSO20CKG	175	MITSO42BKF1	163, 165	NISS009BKP1	233
MERC015BKF	159	MITSO20CKG1	172				
MERC016B	159	MITSO20CKG2	170				

# Product Codes

Part Number	Page	Part Number	Page	Part Number	Page	Part Number	Page
NISS009C	220, 224, 227, 230	NISS024CKP	222	NISS040B	161, 198, 199, 201, 202, 205, 213, 236, 241	NISS043CKF	222, 226, 231
NISS009CKF	231	NISS024DKF	231	NISS040C	161, 198, 199, 200, 201, 202, 204, 205, 211, 213, 236, 241	NISS043CKF1	222
NISS009CKG	231	NISS024DKG	231	NISS040D	161, 198, 199, 201, 202, 204, 211, 241	NISS043CKFL	226, 231
NISS009CKP	231	NISS024DKP	231	NISS041B	204, 205	NISS043CKP	222, 226, 231
NISS010B	231, 233	NISS025	207	NISS041BKF	205	NISS043CKP1	222
NISS010C	221, 231, 233	NISS025AKG	207	NISS041BKF1	204	NISS043CKPL	226, 231
NISS011CD/S	229	NISS025BKG	207	NISS041BKG	205	NISS044B	221, 225, 231, 233
NISS011CKF	229	NISS025CKG	207	NISS041BKG1	204	NISS044C	221, 225, 231
NISS011CKG	229	NISS026B	220, 224, 230, 232	NISS041BKP	205	NISS045A	217
NISS011CKP	229	NISS026BKF	222, 226, 231, 233	NISS041BKP1	204	NISS045AKF	217
NISS011CN/S	229	NISS026BKF1	222	NISS041CK	205	NISS045AKG	217
NISS011DKF	229	NISS026BKF1L	222	NISS041CKF1	204	NISS045AKP	217
NISS011DKG	229	NISS026BKFL	222, 226, 231, 233	NISS041CKG	205	NISS045B	217
NISS011DKP	229	NISS026BKP	222, 226, 231, 233	NISS041CKG1	204	NISS045BKF	217
NISS012CD/S	227, 229	NISS026BKP1	222	NISS041CKP	205	NISS045BKG	217
NISS012CN/S	227, 229	NISS026BKP1L	222	NISS041D	204, 205	NISS045BKP	217
NISS012DD/S	227, 229	NISS026BKPL	222, 226, 231, 233	NISS041DKF	204	NISS045C	217
NISS012DN/S	227, 229	NISS026CKF	222, 226, 231	NISS041DKG	205	NISS045CKF	217
NISS013	208	NISS026CKF1	222	NISS041DKG1	204	NISS045CKG	217
NISS014AD/S	207, 208	NISS026CKFL	226, 231	NISS041DKP	205	NISS045CKP	217
NISS014AKF	208	NISS026CKP	222, 226, 231	NISS041DKP1	204	NISS046A	217
NISS014AKG	208	NISS026CKP1	222	NISS042B	211, 213	NISS046B	217
NISS014AN/S	207, 208	NISS026CKPL	226, 231	NISS042BKF	213	NISS046C	217
NISS014BD/S	207, 208	NISS027B	221, 225, 231, 233	NISS042BKF1	211	NISS047B	236
NISS014BKF	208	NISS027C	221, 225, 231	NISS042BKG	213	NISS047BKF	236
NISS014BKG	208	NISS034B	214	NISS042BKG1	211	NISS047BKG	236
NISS014BN/S	207, 208	NISS035B	214	NISS042CKF	213	NISS047BKP	236
NISS014CD/S	207, 208	NISS036CKF	227	NISS042CKF1	211	NISS048	209
NISS014CKF	208	NISS036CKG	227	NISS042CKG	213	NISS049B	209
NISS014CKG	208	NISS036CKP	227	NISS042CKG1	211	NISS049BKG	209
NISS014CN/S	207, 208	NISS036DKF	227	NISS043B	220, 224, 230, 232	NISS057B	199, 202
NISS017	215	NISS036DKG	227	NISS043BKF	222, 226, 231, 233	NISS057BKF	199, 202
NISS018B	215	NISS036DKP	227	NISS043BKF1	222	NISS057BKG	199, 202
NISS018BKF	215	NISS037BKF	226	NISS043BKF1L	222	NISS057C	199, 202
NISS018BKG	215	NISS037BKG	226	NISS043BKFL	222, 226, 231, 233	NISS057CKF	199, 202
NISS018CKF	215	NISS037BKP	226	NISS043BKPL	222	NISS057CKG	199, 202
NISS018CKG	215	NISS037CKF	222, 226	NISS043BKP1	222	NISS057CKP	199, 202
NISS020B	225	NISS037CKG	222, 226	NISS043BKP1L	222	NISS058A	161, 198, 201, 241
NISS020C	221, 225, 231	NISS037CKP	222, 226	NISS043BKPL	222, 226, 231, 233	NISS058B	161, 198, 201, 241
NISS020CKF	231	NISS037DKF	222, 226	NISS043BKP1L	222	NISS058BKF	161, 198, 201, 241
NISS020CKG	231	NISS037DKG	222, 226	NISS043BKP1L	222	NISS058BKG	161, 198, 201, 241
NISS020CKP	231	NISS037DKP	222, 226	NISS043BKP1L	222	NISS058BKP	161, 198, 201, 241
NISS020D	221, 225, 231	NISS038B	237	NISS043BKP1L	222	NISS058C	161, 198, 201, 241
NISS024B	220, 224, 227	NISS039B	237	NISS043BKP1L	222	NISS058CKF	161, 198, 201, 241
NISS024CKF	222	NISS040A	161, 198, 199, 201, 202, 241	NISS043BKPL	222, 226, 231, 233	NISS058CKG	161, 198, 201, 241
NISS024CKG	222						



# Product Codes

Part Number	Page	Part Number	Page	Part Number	Page	Part Number	Page
NISS058CKP	161, 198, 201, 241	RTB040	80, 83	SS016	308	SSANG004B	244
NISS058D	161, 198, 201, 241	RTB041	101, 104	SS017	346	SSANG004BKG	244
NISS058DKF	161, 198, 201, 241	RTB048	200, 240	SS019	311	SSANG004C	244
NISS058DKG	161, 198, 201, 241	RTB050	45, 182	SS019SC	308	SSANG004CKG	244
NISS058DKP	161, 198, 201, 241	RTB051-P	282	SS019SC RAIL	308	SSANG005B	246
PANHARD001	301, 306	RTB051-SP	278	SS031	187	SSANG005BKG	246
PANHARD002	302, 306	RTB060	358	SS033	286	SSANG005C	246
PANHARD003	220, 224, 227, 230, 232	RTB066	52, 56, 60, 150	SS034	358, 360	SSANG005CKG	246
PANHARD004	221, 225, 231, 233	RTB067GLS	178	SS034 RAIL	358, 360	SSANG006B	245
PANHARD005	220	RTB067GLX	178	SS039	150	SSANG006BKG	245
PANHARD006	221	RTB069	50	SS042	203	SSANG006C	245
PANHARD007	301, 306	RTB072	350	SS044	76, 78, 110	SSANG006CKG	245
PANHARD008	220, 224, 227, 230, 232	RTB073	352	SS044 RAIL	76, 78, 110	SSANG010B	249
PANHARD009	220	RTB074	98	SS047	343	SSANG010BKG	249
PANHARD010	127	RTB077JL	124	SS048	200, 240	SSP019SC	308
PANHARD011	127	RTB077JT	118	SS048 RAIL	200, 240	SSP019SC RAIL	308
PANHARD013	309, 312, 316, 320, 324	RTB078	264	SS050	45, 178, 182	SSP056	295
PANHARD013L	309, 312, 316, 320, 324	RTB080	147	SS050 RAIL	45, 178, 182	SSP056 RAIL	295
PANHARD015	265, 271, 341, 344, 347	RTB082	197	SS051	278, 282	SSP064	340
PANHARD015-KDSS	341, 344, 347	RTBPLATE001	52, 56, 60, 150, 278, 282	SS051 RAIL	278, 282	SSP064 RAIL	340
PANHARD016	296, 299	RTBPLATE002	80, 83, 101, 104	SS053	272	SSP082	197
PANHARD017	255	RTBPLATE048	200, 240	SS053 RAIL	272	SSP082 RAIL	197
PANHARD017L	255	RTBPLATE050	45, 178, 182	SS054	52, 56, 60	SSR002	64
PANHARD018	255	RTBSPARE002	371	SS054 RAIL	52, 56, 60	SSR003	203
PATF15	220, 224, 227, 230, 232	RTBSPARE003	371	SS055	67, 69	SSR004	346
PATF30	220, 224, 227, 230, 232	RTBSPARE004	371	SS055 RAIL	67, 69	SSR006	87, 89, 91, 108
PATR15	221, 225, 231, 233	RWC077JL	124	SS057	80, 83, 101, 104	SSR007	154
PATR30	221, 225, 231, 233	SBEXT001	301, 306, 309, 312, 316, 320, 324, 330	SS057 RAIL	80, 83, 101, 104	SSR012	218, 219
PBC055	54, 68	SBEXT002	302, 307	SS059	164	SSR015	323
RAM015A	238, 239	SBEXT003	220, 221, 224, 225, 230, 231, 232, 233	SS072	350	SSR016	308
RAM015B	238, 239	SBEXT004	221, 225	SS072L	350	SSR019	311
RAM015C	238, 239	SBEXT005	302, 307	SS073	352	SSR019SC	308
RAM016A	238, 239	SBEXT006	220, 221, 224, 225, 227, 230, 231, 232, 233, 265, 271, 341, 344, 347	SS074	98, 147	SSR031	187, 190
RAM016AKP	239	SBEXT007	221, 225	SS074 RAIL	98	SSR033	286
RAM016B	238, 239	SBEXT008	127	SS077JL	124	SSR034	358, 360
RAM016BKP	239	SBEXT0075	239	SS077JT	118	SSR039	150
RAM016BKP1	239	See Vehicle Listing	13	SS078	264	SSR042	203
RAM016C	238, 239	SS001	87, 89, 91, 108	SS079	162	SSR044	76, 78, 110
RAM016CKP	239	SS007	203	SS082	197	SSR047	343
RAM016CKP1	239	SS008	64	SS082 RAIL	197	SSR048	200, 240
RAM017AKP	238	SS009	154	SSANG001	247	SSR050	45, 178, 182
RAM017BKP	238	SS012	218, 219	SSANG002B	247	SSR051	278, 282
RAM017CKP	238	SS015	323	SSANG002BKF	247	SSR053	272
REN001B	44, 242			SSANG002BKG	247	SSR054	52, 56, 60
REN001BKG	44, 242			SSANG003B	244, 245, 246, 249	SSR055	67, 69
REN002B	44, 242			SSANG003C	244, 245, 246, 249	SSR057	80, 83, 101, 104

# Product Codes

Part Number	Page	Part Number	Page	Part Number	Page	Part Number	Page
SSR074	98	SUZ009B	255, 257	TB077JL	124	TOY007AD/S	330, 333, 335
SSR080	147	SUZ009BKG	257	TOY001B	337, 339	TOY007AN/S	331, 333, 335
SSR082	197	SUZ009C	255	TOY001BKF	339	TOY007BD/S	330, 333, 335
SSRP011	218	SUZ010B	255, 257	TOY001BKG	339	TOY007BKF1	335
SSRP015	323	SUZ010BKG	255	TOY001BKP	339	TOY007BKF2	333
SSRP016	308	SUZ010BKGGVM	384	TOY002B	339	TOY007BKG1	335
SSRP019	311	SUZ010BKGGVM1	384	TOY003BKF	337	TOY007BKG2	333
SSRP019SC	308	SUZ010C	255	TOY003BKG	337	TOY007BKP1	335
SSRP056	295	SUZ010CKG	255	TOY003BKP	337	TOY007BKP2	333
SSRP064	340	SUZ010CKGGVM	384	TOY003C	337	TOY007BN/S	331, 333, 335
SSRP082	197	SUZ010CKGGVM1	384	TOY004B	336, 338	TOY007CD/S	330, 333, 335
ST10RK	419, 420, 422	SUZ011B	255, 257	TOY004BKF	338	TOY007CKF1	335
ST21RK	419, 420, 422	SUZ011C	255	TOY004BKG	338	TOY007CKF2	333
ST38-1	418, 420, 421	SUZ013B	262	TOY004BKP	338	TOY007CKG1	335
ST39	419, 420	SUZ013BKG	262	TOY004C	336, 338	TOY007CKG2	333
ST710RK	418, 419, 420, 421, 422	SUZ015B	262	TOY005BKF	336	TOY007CKP1	335
ST714RK	418	SUZ016B	262	TOY005BKG	336	TOY007CKP2	333
ST720RK	418, 420, 422	SUZ016BKG	262	TOY005BKP	336	TOY007CN/S	333, 335
ST727RK	419, 420, 422	SUZ017B	262	TOY005C	336	TOY008B	327, 331
SUB001B	251	SUZ018B	262	TOY006AKF	335	TOY008BKF	327
SUB002B	251	SUZ018BKG	262	TOY006AKF1	335	TOY008BKG	327
SUB003B	251	SUZ019AKG	261	TOY006AKF2	333	TOY008BKP	327
SUB004B	251	SUZ019B	261	TOY006AKF3	333	TOY008C	327
SUB005B	251	SUZ019BKG	261	TOY006AKG	335	TOY008CKF	327
SUB006B	251	SUZ019C	261	TOY006AKG1	335	TOY008CKG	327
SUB007BKG	250	SUZ019CKG	261	TOY006AKG2	333	TOY008CKP	327
SUB007CKG	250	SUZ020A	261	TOY006AKG3	333	TOY009B	327
SUB009BKG	252	SUZ020B	261	TOY006AKP	335	TOY009C	327
SUB009BKG1	252	SUZ020C	261	TOY006AKP1	335	TOY009D	327
SUB009CKG	252	TANK001	323	TOY006AKP2	333	TOY009DKF	327
SUB009CKG1	252	TANK002	286	TOY006AKP3	333	TOY009DKG	327
SUB011BKG	253	TANK003	203	TOY006B	332, 334	TOY009DKP	327
SUB011CKG	253	TANK003T	203	TOY006BKF1	335	TOY009E	327
SUZ001BD/S	259	TANK004	45, 178, 182, 187, 190	TOY006BKF2	333	TOY009EFK	327
SUZ001BKG	259	TANK005	187, 190	TOY006BKG1	335	TOY009EKG	327
SUZ001BN/S	259	TANK006	64, 154	TOY006BKG2	333	TOY009EKP	327
SUZ002B	259	TANK007	52, 56, 60, 150	TOY006BKP1	335	TOY010BD/S	292, 293
SUZ002BD/S	259	TANK048	200, 240	TOY006BKP2	333	TOY010BKF1	293
SUZ003B	263	TANK051	278, 282	TOY006C	332, 334	TOY010BKF2	292
SUZ003BKG	263	TANK057	80, 83, 101, 104	TOY006CKF1	335	TOY010BKG1	293
SUZ004B	263	TB040	80, 83	TOY006CKF2	333	TOY010BKG2	292
SUZ005B	262, 263	TB041	101, 104	TOY006CKG1	335	TOY010BN/S	292, 293
SUZ005BKG	263	TB048	200, 240	TOY006CKG2	333	TOY010CD/S	292, 293
SUZ006B	263	TB050	45, 178, 182	TOY006CKP1	335	TOY010CKF1	293
SUZ007B	258	TB051	278, 282	TOY006CKP2	333	TOY010CKF2	292
SUZ008B	258	TB066	52, 56, 60, 124, 150	TOY006D	332, 334	TOY010CKG1	293



# Product Codes

Part Number	Page	Part Number	Page	Part Number	Page	Part Number	Page
TOY010CKG2	292	TOY018BKG	329	TOY038C	86, 107, 129, 266, 349	TOY047B	309, 313, 317, 321
TOY010CN/S	292, 293	TOY019B	329	TOY038CKF	349	TOY047C	309, 313, 317, 321
TOY011B	268, 292, 293	TOY023B	267	TOY038CKF1	349	TOY047CKFGVM	388, 389, 390
TOY011BKF	268	TOY023BKF	267	TOY038CKG	349	TOY047CKFGVM1	388, 389, 390
TOY011BKG	268	TOY023BKG	267	TOY038CKG1	349	TOY047CKPGVM	388, 389, 390
TOY011C	268, 292, 293	TOY023C	267	TOY038CKP	349	TOY047CKPGVM1	388, 389, 390
TOY011CKF	268	TOY023CKF	267	TOY038CKP1	349	TOY047D	309, 313, 317, 321
TOY011CKG	268	TOY023CKG	267	TOY039A	266, 349	TOY047DKFGVM	388, 389, 390
TOY012C	301, 306	TOY024B	301, 306	TOY039B	266, 349	TOY047DKFGVM1	388, 389, 390
TOY012CKF1	302, 307	TOY024BKF	302, 307	TOY039C	266, 349	TOY047DKPGVM	388, 389, 390
TOY012CKF1L	302, 307	TOY024BKG	302, 307	TOY042	277	TOY047DKPGVM1	388, 389, 390
TOY012CKF2	302, 307	TOY024BKP	302, 307	TOY044C	277	TOY047E	309, 313, 317, 321
TOY012CKF2L	302, 307	TOY024C	301, 306	TOY044CKF	277	TOY047EKFGVM	388, 389, 390
TOY012CKP1	302, 307	TOY024CKF	302, 307	TOY044CKG	277	TOY047EKFGVM1	388, 389, 390
TOY012CKP1L	302, 307	TOY024CKG	302, 307	TOY046A	309, 312, 316, 320, 324, 330	TOY047EKPGVM	388, 389, 390
TOY012CKP2	302, 307	TOY024CKP	302, 307	TOY046AKF	317, 321	TOY047EKPGVM1	388, 389, 390
TOY012CKP2L	302, 307	TOY024DKF	302, 307	TOY046AKF1	310	TOY048B	328
TOY013B	301, 304, 306	TOY024DKG	302, 307	TOY046AKG	317, 321	TOY048BKF	328
TOY013C	301, 306	TOY024DKP	302, 307	TOY046AKG1	310	TOY048BKG	328
TOY013D	301, 306	TOY025B	301, 306	TOY046AKP	317, 321	TOY048C	328
TOY016AKF	331	TOY025C	301, 304, 306	TOY046AKP1	310	TOY048CKF	328
TOY016AKG	331	TOY025D	301, 304, 306	TOY046B	309, 312, 316, 320, 324, 330	TOY048CKG	328
TOY016AKP	331	TOY026	267, 268, 291	TOY046BKF	317, 321	TOY049B	328
TOY016BKF	331	TOY027A	291	TOY046BKF1	310, 313	TOY049C	328
TOY016BKG	331	TOY027AKF	291	TOY046BKG	317, 321	TOY050	304
TOY016BKP	331	TOY027AKG	291	TOY046BKG1	310, 313	TOY050BKF	304
TOY017A	273, 275	TOY027B	291	TOY046BKP	317, 321	TOY050BKG	304
TOY017AKF	275	TOY027BKF	291	TOY046BKP1	310, 313	TOY050BKP	304
TOY017AKF1	273	TOY027BKG	291	TOY046C	309, 312, 316, 320, 324, 330	TOY050CKF	304
TOY017AKG	275	TOY027C	291	TOY046CKF	317, 321	TOY050CKG	304
TOY017AKG1	273	TOY027CKF	291	TOY046CKF1	310, 313	TOY050CKP	304
TOY017AKP	275	TOY027CKG	291	TOY046CKG	317, 321	TOY050DKF	304
TOY017AKP1	273	TOY034B	338	TOY046CKG1	310, 313	TOY050DKG	304
TOY017B	273, 275	TOY038AKF	266, 349	TOY046CKP	317, 321	TOY050DKP	304
TOY017BKF	275	TOY038AKF1	349	TOY046CKP1	310, 313	TOY051	304
TOY017BKF1	273	TOY038AKG	266, 349	TOY046DKF	317, 321	TOY051BKF	304
TOY017BKG	275	TOY038AKG1	349	TOY046DKF1	310, 313	TOY051BKG	304
TOY017BKG1	273	TOY038AKP	266, 349	TOY046DKG	317, 321	TOY051BKP	304
TOY017BKP	275	TOY038AKP1	349	TOY046DKG1	310, 313	TOY051CKF	304
TOY017BKP1	273	TOY038B	86, 107, 129, 266, 349	TOY046DKP	317, 321	TOY051CKG	304
TOY017S	273, 275	TOY038BKF	266, 349	TOY046DKP1	310, 313	TOY051CKP	304
TOY017SKF	275	TOY038BKF1	266, 349	TOY046DKP1	310, 313	TOY051DKF	304
TOY017SKG	275	TOY038BKG	266, 349	TOY046EKF	317, 321	TOY051DKG	304
TOY017SKP	275	TOY038BKG1	266, 349	TOY046EKF1	310, 313	TOY051DKP	304
TOY018B	329	TOY038BKP	266, 349	TOY046EKP	317, 321	TOY055A	129, 271, 273, 275, 280, 284, 287, 346
TOY018BKF	329	TOY038BKP1	266, 349	TOY046EKP1	310, 313		
				TOY047A	309, 317, 321		



# Product Codes

Part Number	Page	Part Number	Page	Part Number	Page	Part Number	Page
TOY077D	280, 284	UBP033	286	UCA056FA	296, 299	WWB010	371
TOY077DKF	281, 285	UBP033MK	371	UCA073FA	353	WWB011	371
TOY077DKF1GVM	385	UBP041	78, 83, 101, 104, 110	UCA074FA	99, 148	WWB012	371
TOY077DKF1GVM1	385	UBP041MK	371	UCA075FA	238, 239	WWB013	371
TOY077DKFGVM	385	UBP047	264, 270, 340, 343	UCAB001	370	WWB014	371
TOY077DKFGVM1	385	UBP047MK	371	UCAB041	370	WWB015	371
TOY077DKG	281, 285	UBP048	200, 240	UCAB041S	370	WWB016	371
TOY077DKP	281, 285	UBP048MK	371	UCAB048	370	WWB017	371
TOY077DKP1GVM	385	UBP048S	200, 240	UCAB050	370	WWB018	371
TOY077DKP1GVM1	385	UBP050	45, 162, 178, 182	UCAB054	370	WWB019	372
TOY077DKPGVM	385	UBP050MK	371	UCAB056	370	WWB020	372
TOY077DKPGVM1	385	UBP051	272, 278, 282	UCAB073	370	WWB021	372
TOY079B	309, 312, 316, 320, 324	UBP051MK	371	UCAB074	370	WWB022	372
TOY080A	269	UBP054	56, 60, 69, 150	UCAB075	370	WWB023	371
TOY082A	269	UBP054MK	371	UTA001	302, 306	WWB024	371
TOY055A	94	UBP055	52, 56, 67, 150	UTA003	221, 225, 231, 233, 304	WWB025	371
TOY055B	94	UBP055MK	371	UTA200	296, 299	WWB026	371
TOY055C	94	UBP056	295, 298	UTEBOX001	34	WWB12000	10
TROL001B	354	UBP056MK	371	UTEBOX002	34	WWB12000SR	10
TROL001BKG	354	UBP057	76, 80	VOLKS001B	359, 361	WWB9500	10
TROL002B	354	UBP057MK	371	VOLKS001BKG	359, 361	WWB9500SR	10
TROL003B	355	UBP070	254	VOLKS001C	359, 361	WWWBRAKE	371
TROL003BKG	355	UBP072	350	VOLKS001CKG	359, 361	WWW CARTON12	372
TROL004B	355	UBP073	352	VOLKS001D	359, 361	WWW CARTON95	372
UBJ001K	370	UBP074	98, 147	VOLKS002B	359, 361	WWWCLUTCH	371
UBJ041K	370	UBP074S	98, 147	VOLKS002C	359, 361	WWWDRUM	371
UBJ041SK	370	UBP201SY	243, 248	WINCH BLANKET	10, 371	WWWDRUMBUSH	372
UBJ048K	370	UBP201SYMK	371	WWB001	371	WWWENDPLATE GBOX	372
UBJ050K	370	UCA001FA	265, 271, 273, 275, 280, 284, 287, 341, 344, 346, 351	WWB002	371	WWWENDPLATE MOTOR	372
UBJ054K	370	UCA001FAS	94	WWB003	371	WWWFAIRLEAD	372
UBJ056K	370	UCA041FA	77, 79, 81, 84, 142	WWB003B	371	WWWHAWSE	10
UBJ073K	370	UCA041FAS	102, 105, 111	WWB004	371	WWWMOTOR12	372
UBJ074K	370	UCA048FA	198, 199, 201, 202, 204, 205, 211, 213, 236, 241	WWB004B	371	WWWMOTOR95	372
UBJ075K	370	UCA050FA	46, 163, 165, 180, 184, 188, 191	WWB005	371	WWWORING	372
UBP019	308, 311, 315, 323	UCA054FA	54, 58, 62, 68, 70, 152	WWB006	371	WWWREMOTE WIRELESS	372
UBP019MK	371			WWB007	371	WWWROPE001	10
UBP019SC	308			WWB008	371	WWWTAG12	372
UBP019SCMK	371			WWB009	371	WWWTAG95	372



# Terms and Conditions

## 1. Interpretation

In these Terms and Conditions of Sale ("Terms"), "Goods" means the Goods the subject of the Contract; IRONMAN 4X4 Pty. Ltd. means the entity selling the Goods; "Buyer" means the entity purchasing the Goods; "Contract" means each contract between IRONMAN 4X4 Pty. Ltd. and the Buyer for the sale and purchase of the Goods and "order" includes "offer".

## 2. Terms and Conditions

The only Terms of the Contract are those agreed to in writing by IRONMAN 4X4 Pty. Ltd. These Terms (to the extent they are not inconsistent with Terms agreed to in writing by IRONMAN 4X4 Pty. Ltd.) and those which are implied or imposed by law (including the Trade Practices Act 1974) to the extent that it is not lawful or possible to exclude them. All other Terms, Conditions and Warranties are expressly excluded. If a conflict arises between the Terms of any order made by the Buyer and these Terms, these Terms will prevail. An agreement to deliver the Goods in instalments is taken to be a separate Contract for each instalment. These Terms and each Contract including them are governed by the laws of New South Wales, and IRONMAN 4X4 Pty. Ltd. and the Buyer submit to the jurisdiction of the courts of that State. If a Term is held to be unenforceable, the remaining Terms will apply.

## 3. Quotations and Orders

Any quotation made by IRONMAN 4X4 Pty. Ltd. will not be construed or operate as an offer or obligation to sell. IRONMAN 4X4 Pty. Ltd. reserves the right to accept or reject in its absolute discretion any order received by it. The Buyer will not be entitled to cancel or refuse delivery of, or payment for, any order made by it which has been accepted by IRONMAN 4X4 Pty. Ltd.

## 4. Price

The price payable to IRONMAN 4X4 Pty. Ltd. by the Buyer for the Goods will be the price agreed; failing which it will be the price prevailing at the date the Goods are dispatched by IRONMAN 4X4 Pty. Ltd. for delivery to the Buyer. Prices are payable in Australian currency and exclusive of delivery costs, taxes, duties and other imposts which, if changeable, are payable by the Buyer. Prices quoted in any IRONMAN 4X4 Pty. Ltd. Price List are suggested prices only and may be changed by IRONMAN 4X4 Pty. Ltd. without notice.

## 5. Payment

The Buyer must pay cash for the Goods on delivery or, at IRONMAN 4X4 Pty. Ltd.'s absolute discretion, strictly within 30 days of delivery. IRONMAN 4X4 Pty. Ltd. will appropriate payments first to outstanding interest and then to outstanding accounts in the date order rendered.

## 6. Overdue Amounts

If Buyer fails to pay all or part of any amount to IRONMAN 4X4 Pty. Ltd. when due, interest will be payable on that amount from its due date until it is paid in full at a rate equivalent to 2% per annum above the overdraft rate from time to time charged to IRONMAN 4X4 Pty. Ltd. by its principal banker.

## 7. Delivery

IRONMAN 4X4 Pty. Ltd. will make all reasonable efforts to deliver the Goods on the dates agreed, to the place or carrier designated by the Buyer. IRONMAN 4X4 Pty. Ltd. has the right to make delivery in instalments and to deliver those Goods available for delivery. The Buyer has no right to terminate the Contract because of a delay in delivery.

## 8. Warranty

IRONMAN 4X4 Pty. Ltd. warrants that its products are manufactured to S.A.E.- Society of Automotive Engineers - specifications for the particular product. IRONMAN 4X4 Pty. Ltd. further warrants that all products sold hereunder are free from defects in material and workmanship.

IRONMAN 4X4 Pty. Ltd. will, at its sole option, repair or replace any products supplied by it which are found to be defective in either materials or workmanship providing that IRONMAN 4X4 Pty. Ltd. is actually notified in writing from the Buyer of the alleged defect within ninety (90) days from the date of invoice. Any claim not made within this period shall conclusively be deemed waived by the Buyer. Repair or replacement is preconditioned on the examination of the Goods by IRONMAN 4X4 Pty. Ltd. and, if requested by IRONMAN 4X4 Pty. Ltd. return of the Goods to IRONMAN 4X4 Pty. Ltd.

No products are to be returned to IRONMAN 4X4 Pty. Ltd. without its written consent, according to procedures outlined in this manual, and the receipt by the Buyer of specific shipping instructions. IRONMAN 4X4 Pty. Ltd. shall not be liable for any expense incurred by the Buyer in order to remedy any defect in its products. IRONMAN 4X4 Pty. Ltd. shall not be liable for any consequential, special, indirect or contingent damage, or expense arising directly or indirectly from any defect in its products or from use of any products. This warranty does not apply to (1) Goods bought for industrial, mining or agricultural use, (2) Goods bought for resupply or resale, (3) Goods no longer required by the Buyer, (4) Goods incorrectly chosen by the Buyer; or (5) Goods modified or altered by the Buyer (including changing colour).

Except as set forth herein, and except as to title, it is expressly agreed (A) that there is no warranty or merchantability or fitness for a particular purpose, nor other warranty express, implied or statutory nor any affirmation of fact, or promises by IRONMAN 4X4 Pty. Ltd. with reference to the goods which extends beyond the specifications, agreed upon by IRONMAN 4X4 Pty. Ltd. and the Buyer and (b) that the Buyer if any, mutually acknowledges that it is purchasing the goods solely on the basis of the commitments of IRONMAN 4X4 Pty. Ltd. expressly set forth herein. No person is authorised to change or add to any of IRONMAN 4X4 Pty. Ltd.'s obligations under this warranty. In no event shall IRONMAN 4X4 Pty. Ltd. be liable for anticipated profits or for incidental or consequential damages.

The Buyer agrees to indemnify and hold IRONMAN 4X4 Pty. Ltd. harmless from and against any loss, injury or damage, to person or property, that extends beyond the warranties set forth above, whether the claims against IRONMAN 4X4 Pty. Ltd. or the damages are incidental or consequential.

**1 Year Warranty** - *Accessories / Mining Accessories / Underbody Protection*

**2 Year Warranty** - *Premium Underbody Protection / GVM Upgrades / Load Plus*

**3 Year Components Warranty** - *Ice Cube Fridge/Freezers*

**3 Year 60,000km Warranty** - *Suspension*

**5 Year Warranty** - *Monster Winches, Snorkel*

**5 Year Compressor Warranty** - *Ice Cube Fridge/Freezers*

**Lifetime Limited Warranty** - *TREDS*

IRONMAN 4X4 Pty. Ltd. warrants the original buyer, only when purchased new via authorised IRONMAN 4X4 Pty. Ltd. resellers and distributors, from date of sale.

Product is warranted against defects in material or workmanship that cause the product to perform below the specified limits set by IRONMAN 4X4 Pty. Ltd., to the extent that IRONMAN 4X4 Pty. Ltd. will repair or replace any parts which are found to be defective.

All warranty claims must be submitted via original purchasing store or chain, unless otherwise arranged.

Proof of original purchase must be presented upon request.

Products may require to be returned to IRONMAN 4X4 Pty. Ltd. for assessment or repair. Postage and removal costs involved are not the responsibility of IRONMAN 4X4 Pty. Ltd., and may only be considered upon discretion by IRONMAN 4X4 Pty. Ltd. in the event of such claim being verified.

The warranty does NOT apply where, 1) acts of neglect or misuse are evident, 2) product has been modified, 3) vehicles which are modified or not the recommended vehicle of use, 4) used in racing or competition conditions without the prior consent of IRONMAN 4X4 Pty. Ltd., 5) used beyond the expectations of the original vehicle manufacturer.



# Terms and Conditions

Before installation of any product, please ensure you have received the correct parts for your application.

Ordering of the correct parts is the responsibility of the Buyer. Return of a product in an unused condition will attract a 15% restock fee, where IRONMAN 4X4 Pty. Ltd. is not at fault.

Return of used or soiled product, 1) outside warranty period, 2) without fault, will result in refusal of your claim and be returned at the Buyer's expense.

Damage to products through fitment error is not covered under warranty.

## 9. Damage

The Buyer acknowledges that the Goods leaving IRONMAN 4X4 Pty. Ltd's premises are adequately packed. Claims for damage in transit must be made against the carrier and, while IRONMAN 4X4 Pty. Ltd. will not accept liability for any damage, details of any claim must be promptly advised to IRONMAN 4X4 Pty. Ltd. Prior to acknowledging delivery to the carrier, the Buyer must ensure that the complete consignment has been received as specified in the carrier's note. Any shortage or visible damage to outer packaging must be endorsed on the carrier's note. Any shortages and/or damages must be reported to IRONMAN 4X4 Pty. Ltd. within 72 hours or receipt.

## 10. Title

10.1 Title to the Goods will not pass to the Buyer until the earlier of:

- (a) IRONMAN 4X4 Pty. Ltd. being paid in full under all Contracts; or
- (b) the sale by the Buyer of the Goods in its ordinary course of business (in which case the Buyer must keep an accurate account of each sale, hold the proceeds of each sale separate from the Buyer's own money and pay IRONMAN 4X4 Pty. Ltd. in full from the proceeds of the purchase price of each sale, despite that the payment is not otherwise due).

10.2 Until title to the Goods passes to the Buyer, the Buyer must:

- (a) hold the Goods as bailed for IRONMAN 4X4 Pty. Ltd. and keep them in good order and condition;
- (b) not remove any markings placed by IRONMAN 4X4 Pty. Ltd. and ensure that the Goods can be readily identified and distinguished from other property in the Buyer's possession; and
- (c) deliver the Goods to IRONMAN 4X4 Pty. Ltd. immediately upon demand and, for this purpose, IRONMAN 4X4 Pty. Ltd. is authorised to enter at any time any premises on which the Goods may be located (the costs incidental to which will be borne by the Buyer).

## 11. Risk

Risk in the Goods (including insurance responsibility) passes to the Buyer on delivery of the Goods to the place or carrier designated by the Buyer or, if sooner, possession of the Goods passes to the Buyer or its agent.

## 12. Implied Terms, Limitation of Liability and Buyers Indemnity

12.1 Subject to Clause 2, IRONMAN 4X4 Pty. Ltd's liability for any breach of a condition or warranty imposed or implied by law in respect of any Goods or services which are not of a kind ordinarily acquired for personal, domestic or household use or consumption (provided that this provision does not apply if the Buyer establishes that it is not fair or reasonable for IRONMAN 4X4 Pty. Ltd. to rely on it) will be limited to:

- (a) in the case of Goods supplied, any one or more of the following (as IRONMAN 4X4 Pty. Ltd. may determine):
  - (i) replacement of the Goods or the supply of equivalent goods; (ii) repair of the Goods;
  - (iii) payment of the cost of replacing the Goods or of acquiring or obtaining equivalent goods; or

(iv) payment of the cost of having the Goods repaired; and

(b) in the case of services supplied, any one of the following (as IRONMAN 4X4 Pty. Ltd. may determine);

(i) supplying the services again; or (ii) payment of the costs of having the services supplied again.

12.2 Subject to these Terms, IRONMAN 4X4 Pty. Ltd. will not be liable for any loss, damage, expense or injury of any kind or nature suffered or incurred by the Buyer or any other person, arising out of or in connection with, the Contract (including, without limitation, liability due to negligence or wilful default of IRONMAN 4X4 Pty. Ltd. and any delay in delivery) or any error (whether negligent or not) in information supplied to the Buyer in connection with its subject matter or the use, possession or delivery of the Goods or the exercise by IRONMAN 4X4 Pty. Ltd. of its rights under Clause 16 and the Buyer will indemnify IRONMAN 4X4 Pty. Ltd. in relation to any such loss, damage, expense or injury.

## 13. Claims

Any claim made by the Buyer must be in writing and contain the particulars specified in the IRONMAN 4X4 Pty. Ltd's 'Application for Exchange or Credit' or 'Applications for Warranty' and be received by IRONMAN 4X4 Pty. Ltd. within 14 days after delivery of the Goods. Subject to the Contract, no claim for credit will be recognised where (1) the Goods are made to special order or the Buyer's specifications or drawings, (2) are no longer required by the Buyer, (3) are returned without the particulars required by this Clause, (4) the Buyer has modified or altered the Goods (including changing colour) or (5) if the IRONMAN 4X4 Pty. Ltd. Catalogue stipulates that return will not be accepted. If the Buyer insists on returning the Goods, it must pay IRONMAN 4X4 Pty. Ltd. a handling fee equal to 40% of the price of the Goods.

## 14. Force Majeure

Despite any other Term or condition of the Contract, IRONMAN 4X4 Pty. Ltd. will not be liable for any loss, damage, expense or injury of any kind or nature suffered or incurred by the Buyer or any other person, arising out of or in connection with any delay in delivery, or failure to perform any other term or condition of the Contract where that delay or failure is caused by an act of God, fire, labour dispute, civil commotion, intervention of a Government, inability to obtain labour, materials or manufacturing facilities, accidents, interruptions of or delay in transportation or any other cause beyond IRONMAN 4X4 Pty. Ltd's reasonable control

## 15. Errors or Omissions

IRONMAN 4X4 Pty. Ltd. has the right to correct any clerical errors or omissions, whether in computation or otherwise in any quotation, acknowledgment or document forming part of a Contract.

## 16. Breach by Buyer

If the Buyer breaches a Contract or IRONMAN 4X4 Pty. Ltd. is not satisfied of a Buyer's ability to pay or otherwise comply with each Contract, IRONMAN 4X4 Pty. Ltd. may by notice to the Buyer, but without compensation, terminate every Contract, suspend or cease deliveries under all Contracts, set-off all deposits against amounts due and made all amounts then outstanding by the Buyer to IRONMAN 4X4 Pty. Ltd. immediately due and payable.

## 17. Waiver

IRONMAN 4X4 Pty. Ltd's right under the Contract are cumulative and in addition to any other rights. No delay or failure by IRONMAN 4X4 Pty. Ltd. to enforce any right is a waiver of that right. Any waiver by IRONMAN 4X4 Pty. Ltd. of any term or breach of the Contract is not to be taken as a continuing waiver or a waiver of any subsequent breach.





4WD AND TOURING  
GEAR PRODUCT

ACCESSORIES AND SUSPENSION  
PRODUCT BY VEHICLE

ACCESSORY SPARE PARTS

PRODUCT INSTALL  
TIME GUIDE

GVM UPGRADES

SUSPENSION SELECTION  
AND INFORMATION

SUSPENSION TECHNICAL  
SPECIFICATIONS

ACCESSORY SELECTION  
AND INFORMATION

ACCESSORY TECHNICAL  
SPECIFICATIONS

PRODUCT CODE QUICK  
REFERENCE



**VICTORIA**

2-8 Bessemer Drive,  
Dandenong South, VIC 3175

**NEW SOUTH WALES**

22 Yilen Close,  
Beresfield, NSW 2322

**QUEENSLAND**

160 Robinson Road East,  
Geebung, QLD 4034

**SOUTH AUSTRALIA**

24 Cheltenham Parade,  
Woodville, SA 5011

**WESTERN AUSTRALIA**

Cnr Baile Road and Craft Street,  
Canning Vale, WA 6155

TO CONTACT IRONMAN 4X4  
CALL 1300 731 137 OR VISIT US AT:  
***www.ironman4x4.com***

 Find us on Facebook  
facebook.com/Ironman4x4au

**RETAIL**